

**MONTEREY PENINSULA WATER  
SUPPLY PROJECT**

**REQUEST FOR PROPOSALS**

**FOR THE**

**DESIGN BUILD OF FITCH PARK ASR WELLS 5 AND 6  
ABOVE GROUND FACILITIES**

Issue Date: September 29, 2018

Due Date: October 30, 2018



**CALIFORNIA  
AMERICAN WATER**

Pacific Grove, California

TABLE OF CONTENTS

<b>SECTION 1 INTRODUCTION</b>	1-4
1.1. EXECUTIVE SUMMARY .....	1-4
1.2. PROPOSAL.....	1-5
1.3. PROPOSAL SUBMITTAL.....	1-5
<b>SECTION 2 GENERAL INFORMATION</b>	2-1
2.1. PURPOSE OF SOLICITATION.....	2-1
2.2. <b>MPWSP BACKGROUND AND OBJECTIVES</b> .....	2-1
2.3. <b>PROJECT DESCRIPTION</b> .....	2-2
2.3.1 Generally .....	2-2
2.3.2 Design Build Fitch Park ASR Wells 5 and 6 Above Ground Facilities.....	2-3
2.4. <b>AVAILABLE REPORTS AND MATERIALS</b> .....	2-3
2.5. ACCURACY OF RFP AND RELATED DOCUMENTS; RELIANCE ON ORAL COMMENTS .....	2-3
2.6. <b>PROJECT SITE</b> .....	2-4
2.6.1 Project Site Description.....	2-4
2.6.2 Project Site Preparation .....	2-4
2.6.3 Project Site Access during the Proposal Period .....	2-4
2.7. <b>SCOPE OF WORK</b> .....	2-4
2.7.1 Basic Performance Requirements .....	2-4
2.7.2 Environmental Compliance.....	2-5
2.7.3 Design and Construction .....	2-5
2.7.4 Acceptance Testing .....	2-5
2.7.5 Quality Management .....	2-5
2.7.6 Operation and Maintenance Training.....	2-5
2.8. <b>DRAFT CONTRACT</b> .....	2-5
2.8.1 Purpose and Scope.....	2-5
2.8.2 Proposed Changes to the Draft Contract .....	2-6
2.9. <b>UTILIZATION OF DIVERSE BUSINESS ENTERPRISES</b> .....	2-6
2.10 <b>UTILIZATION OF LOCAL CONTRACTORS AND SUPPLIERS</b> .....	2-7
2.11 <b>LABOR COMPLIANCE AND PREVAILING WAGE</b> .....	2-7
2.12 <b>EQUAL EMPLOYMENT OPPORTUNITY</b> .....	2-7
2.13 <b>LICENSING REQUIREMENTS</b> .....	2-8
2.14 <b>EXAMINATION OF CONTRACT DOCUMENTS AND PROJECT SITE</b> .....	2-8
2.14.1 Proposer’s Responsibilities .....	2-8
2.14.2 Site Visits .....	2-8
2.15 <b>SECURITY FOR PERFORMANCE</b> .....	2-9
<b>SECTION 3 DESCRIPTION OF PROCUREMENT PROCESS</b>	3-1

**Monterey Peninsula Water Supply Project  
Request for Proposals  
Design Build of Fitch Park ASR Wells 5 and 6 Above Ground Facilities**

---

3.1.	PROCUREMENT PROCESS SCHEDULE .....	3-1
3.1.1	Pre-Proposal Meeting .....	3-1
3.2.	SELECTION COMMITTEE .....	3-2
3.3.	CAWC RIGHTS AND OPTIONS .....	3-2
3.4.	EXPENSE OF PROPOSAL PREPARATION .....	3-3
3.5.	ADDENDA TO RFP .....	3-3
3.6.	COMMUNICATIONS PROTOCOL.....	3-4
3.7.	USE OF TECHNICAL INFORMATION.....	3-4
3.8.	INFORMATION DISCLOSURE TO THIRD PARTIES.....	3-5
3.9.	PRIOR EXPERIENCE.....	3-5
3.10.	EVALUATION AND RANKING OF PROPOSALS .....	3-5
3.11.	NEGOTIATION OF CONTRACT .....	3-6
<b>SECTION 4 PROPOSAL REQUIREMENTS</b>		<b>4-1</b>
4.1.	OVERVIEW OF SUBMISSION REQUIREMENTS AND CRITERIA FOR PROPOSALS .....	4-1
4.2.	PROPOSAL FORMAT .....	4-1
4.3	PROPOSAL SUBMISSION .....	4-2
4.3.1.	Proposal Deadline.....	4-2
4.3.2.	Number of Copies .....	4-3
4.4.	PROPOSAL CONTENTS.....	4-3
4.4.1.	Section 1.0: Executive Summary .....	4-3
4.4.2.	Section 2.0: Project Team Information .....	4-4
4.4.3.	Section 4.0: Business and Price Proposal.....	4-7
4.5.	PROPOSAL FORMS GENERALLY .....	4-8
5.	EVALUATION OF PROPOSALS	4-9
5.1.	EVALUATION OF PROPOSALS .....	4-9
5.2.	EVALUATION CRITERIA.....	4-9
5.2.1.	Weighting of Evaluation Criteria .....	4-9
5.2.2.	Technical Criteria .....	10
5.2.3.	Commercial Criteria .....	10
	Terms and Conditions .....	10

**ATTACHMENTS**

**A. PROPOSAL FORMS**

Proposal Form 1	Transmittal Letter
Proposal Form 2	Non-Collusion Affidavit
Proposal Form 3	Disclaimer Statement
Proposal Form 4	Key Personnel
Proposal Form 5	Preliminary Project Schedule, Scheduled Construction Date, and Scheduled Acceptance Date
Proposal Form 6	Acceptance of the Contract
Proposal Form 7	Price Escalator Indices
Proposal Form 8	Diverse Business Enterprise Requirement Statement

**B. REQUEST FOR PROPOSAL SUBMITTAL DOCUMENTS** (including Draft Contract, Exhibit A – *DBE Good Faith Efforts Requirements*, and Exhibit B - *Davis Bacon Contract Provisions*)



## SECTION 1

### INTRODUCTION

#### 1.1. EXECUTIVE SUMMARY

California-American Water Company (“CAWC”) through this Request for Proposals (“RFP”) is soliciting sealed Proposals from qualified respondents (“Proposers”) for a contract to Design and Build the Fitch Park ASR-5 and ASR-6 Wells Above Ground Facilities (“Project”).

This Project is a central component of the MPWSP. The purpose of the MPWSP is to replace a significant portion of the existing water supply from the Carmel River, as directed by the State Water Resources Control Board (“SWRCB”). CAWC is proposing a three-pronged approach to replace the water supply reductions ordered by the SWRCB. The three prongs consist of: (1) desalination, (2) groundwater replenishment (“GWR”), and (3) aquifer storage and recovery (“ASR”). This RFP is being issued to design and build the above ground facilities that will support the ASR program.

The project requires a Design Build Contractor (Contractor) to design, build, install complete, functional, and fully operational above ground facilities for two Aquifer Storage and Recovery (ASR) well facilities in Seaside, California; a location map of the project sites is presented in Appendix A, Sheet T-1. The sites are currently undeveloped easement parcels along the eastern side of General Jim Moore Blvd., immediately west of Ardennes Circle.

CAWC, the Monterey Peninsula Regional Water Authority, the Monterey Peninsula Water Management District, and the County of Monterey have formed an oversight committee (the “Governance Committee”) to ensure efficient and effective public input into the development and operation of the MPSWP. The Governance Committee was formed pursuant to an agreement of the Governance Committee members dated March 8, 2013 (the “Governance Committee Agreement”).

Additional information concerning the MPWSP history, the Project Site conditions, background technical and environmental documents, the Governance Committee Agreement, and public outreach are available on the MPWSP website at [www.watersupplyproject.org](http://www.watersupplyproject.org) (the “MPWSP Website”).

CAWC expects to enter into one contract for the Project (the “Contract”) with the Proposer that submits the most advantageous Proposal as determined by CAWC with input from the Governance Committee.

This RFP provides background information for the Project, a description of the overall procurement process, the Proposal submission requirements, and the evaluation criteria that will be used to select a firm to perform the Contract. A draft Contract is included with this RFP. Unless otherwise defined in this RFP, all capitalized words, abbreviations and terms used herein shall have the meanings that will be set forth in the draft Contract.

## **1.2. PROPOSAL**

**IN ORDER TO BE CONSIDERED RESPONSIVE TO THIS RFP, PROPOSERS SHALL PROVIDE ALL REQUESTED INFORMATION IN ACCORDANCE WITH THE REQUIREMENTS OF THIS RFP.**

CAWC is soliciting a detailed Proposal with specific forms and textual requirements from the Proposers. Proposals shall comply with the submittal requirements for Proposals outlined in Section 4 of this RFP. Proposers shall provide adequate information with respect to their proposed design, construction management and construction methods in order to demonstrate that: (1) the Project can be completed within the Project schedule; (2) the Project will be designed and constructed in accordance with the Contract; and (3) the completed Project will meet the standards for acceptance in accordance with the draft Contract.

## **1.3. PROPOSAL SUBMITTAL**

Proposals must be submitted and received by CAWC, pursuant to Section 4 of this RFP, **NO LATER THAN 3:00 P.M., PACIFIC DAYLIGHT TIME (“PDT”), ON AUGUST X, 2018.** All Proposals shall be submitted in sealed packages and in accordance with the requirements of Section 4 of this RFP.

By submitting a Proposal, Proposers acknowledge and agree to the following conditions:

- All Proposals submitted in response to this RFP will become the property of CAWC and will be subject to disclosure as and to the extent provided in Section 3 of this RFP.
- CAWC’s selection of a Proposal shall not waive or limit any assumptions of risk, provision of indemnity, or other obligations of the Contractor under the Contract, as may be executed between a Proposer and CAWC.
- Proposers shall comply with the communications protocol set forth in Section 3 of this RFP with respect to all communications concerning this RFP.
- Proposals shall comply with all requirements of Section 4 of this RFP. Failure to comply with Section 4 of this RFP may result in a Proposer being deemed unresponsive by CAWC.
- The qualification of the Proposers to receive this RFP and provide a Proposal does not waive or abridge CAWC’s right to find that any Proposer or Proposal is non-responsive to the requirements of this RFP or to find that a Proposer is less qualified than another Proposer and have their evaluation scoring reflect such finding.
- After selection of a Proposal, the selected Proposer shall be required to execute the Contract following the conclusion of successful negotiations with the selected Proposer.

## **SECTION 2**

### **GENERAL INFORMATION**

#### **2.1. PURPOSE OF SOLICITATION**

CAWC is soliciting Proposals from the Proposers identified in Section 1.1 of this RFP to perform the design and construction work for the Project as required by the draft Contract. The design and construction work described in this paragraph is referred to herein as the “Work.”

CAWC intends to select one qualified Proposer that provides CAWC the benefits discussed below and that best meets CAWC’s objectives set forth in Section 2.2 of this RFP. CAWC will select the most advantageous Proposal by applying the evaluation criteria contained in Section 5 of this RFP to the Proposals.

CAWC expects any firm it contracts with will: (a) be efficient; (b) demonstrate that its design, construction management and construction methods are cost-effective; (c) have an optimal Project schedule; (d) provide a clear assignment of responsibilities through a single contracting entity (for each component of work); and (e) possess an exceptional safety record and be green flagged in AVETTA or can become green flagged in AVETTA prior to the execution of the Contract.

#### **2.2. MPWSP BACKGROUND AND OBJECTIVES**

CAWC has served the Monterey Peninsula since it acquired properties from California Water & Telephone Company in 1966. CAWC’s Monterey service area is located in the semi-arid central California coastal area that is currently entirely dependent on local rainfall for its water supply; imported water is not an available option. By reason of its geography and rainfall patterns, the area is prone to severe droughts. Wells located along the Carmel River that draw water from the Carmel River Aquifer are the primary source of water for CAWC. An additional source of water for CAWC is a network of eight wells located in the Seaside Basin, which CAWC shares with a number of users and purveyors.

The CAWC Monterey service area, also known as the Monterey County District, includes six incorporated cities, the Monterey Airport District, the unincorporated areas of Carmel Highlands, Carmel Valley, and Pebble Beach, and other unincorporated areas in Monterey County. The City of Marina, unincorporated Castroville, and other areas of unincorporated Monterey County lie north of the CAWC service area. The MPWSP is needed to replace existing supplies that are constrained by recent legal decisions affecting the Carmel River and Seaside Groundwater Basin water resources: SWRCB Order No. WR 95-10 (“Order 95-10”) and the Monterey County Superior Court adjudication of water rights in the Seaside Groundwater Basin. Both rulings reduce CAWC’s use of its two primary sources of supply for the Monterey County District and provide the most immediate impetus for the MPWSP. In addition, in October 2009, the SWRCB issued a Cease and Desist Order (“CDO”) claiming CAWC had not complied with Order 95-10, requiring CAWC to terminate unauthorized diversions from the Carmel River, and that these diversions constitute a trespass of water. The CDO, as amended in July of 2016, imposes certain milestones

**Monterey Peninsula Water Supply Project  
Request for Proposals  
Design Build of Fitch Park ASR Wells 5 and 6 Above Ground Facilities**

and a deadline of December 31, 2021, for CAWC to reduce its diversion of water from the Carmel River by approximately 70%.

The MPWSP is the result of a multi-year planning effort that has considered several different proposed projects and various related documents. Since 1989, several options have been proposed that proponents have hoped would meet the water supply needs of the Monterey Peninsula and address the impacts on the Carmel River underlying Order 95-10, as well as the Seaside Basin adjudication. The objectives that were considered during development of the MPWSP are as follows:

- Satisfy CAWC’s obligations to meet the requirements of Order 95-10;
- Diversify and create a reliable drought-proof water supply;
- Protect the Seaside Groundwater Basin for long-term reliability;
- Protect the local economy from the effects of an uncertain water supply;
- Minimize water rate increases by creating a diversified water supply portfolio;
- Minimize energy requirements and greenhouse gas emissions per unit of water delivered to the extent possible;
- Provide facilities that can accommodate sea level changes;
- Explore opportunities for regional partnerships; and
- Provide flexibility to incorporate alternative water supply sources, such as GWR.

CAWC submitted an application to the California Public Utilities Commission (“CPUC”) for the MPWSP in April 2012. The MPWSP consists of several distinct components: a source water intake system consisting of slant wells; a desalination plant; a brine discharge system; water conveyance pipelines and storage facilities; and an ASR system. In addition, the Monterey Regional Water Pollution Control Agency (“PCA”) is constructing a 3,500 acre foot per year GWR project that is expected to reduce the size of the MPWSP’s desalination plant from 9.6 mgd to 6.4 mgd.

The CPUC and the Monterey Bay National Marine Sanctuary, as co-Lead Agencies under the National Environmental Policy Act and the California Environmental Quality Act, issued the Final Environmental Impact Report/Environmental Impact Statement (“Final EIR/EIRS”) in March 2018. A final decision certifying the Final EIR/EIS and approving the entire MPWSP is expected by Q3 2018. Following approval by the CPUC, CAWC expects to obtain coastal development permits by Q1 2019. With the permitting approvals progressing and the CDO date approaching, CAWC would like to have the Contractor for the Project in place as soon as possible.

## **2.3. PROJECT DESCRIPTION**

### **2.3.1 Generally**

The Contractor will be asked to provide all necessary design, construction, commissioning, start-up and testing services to bring the Project described in this section of this RFP on-line

### **2.3.2 Design Build Fitch Park ASR Wells 5 and 6 Above Ground Facilities**

The Project components are to be designed and constructed at the respective Project Site locations, as described below and in the draft Contract.

Structures and facilities that are components of this Project are expected to consist of the following: Two complete ASR well above ground facilities as specified. The facilities will be identified as the Fitch Park ASR-5 and ASR-6 Above Ground Facilities (FP ASR-5 and ASR-6). The design production capacity of each of the wells is 3,000 gallons per minute with an injection capacity of 1,500 (gpm).

### **2.4. AVAILABLE REPORTS AND MATERIALS**

Certain Project, Project Site-related, and relevant background information are available for review by the Proposers at the MPWSP Website. The following documents are (or will be) available for review on the MPWSP Website:

- Governance Committee Agreement
- Final EIR/EIS, March 2018
- Project procurement documents, drawings, specifications, and other material

### **2.5. ACCURACY OF RFP AND RELATED DOCUMENTS; RELIANCE ON ORAL COMMENTS**

Except as specifically set forth in the draft Contract, CAWC neither makes any representation or warranty with respect to nor assumes any responsibility for the appropriateness, completeness or the accuracy of this RFP or any of the related documents, addenda or information provided in connection with this RFP, including the available reports and materials provided on the MPWSP Website. Under no circumstances shall a Proposer to this RFP rely on verbal statements made on behalf of CAWC or any of their respective agents, employees, contractors, advisors or consultants. To the best of its ability, CAWC has tried to provide timely and up-to-date information; however, CAWC cannot guarantee the accuracy or completeness of all data provided. Thus, Proposers are cautioned to use their best judgment in determining how to use the data and information provided, and whether or not further independent research and due diligence is required for the preparation of their Proposals and the subsequent delivery of the Work under the Contract. Except as specifically provided in the Contract, no information derived from any part of the foregoing documents, this RFP or from CAWC or any of their respective agents, employees, contractors, advisors or consultants shall relieve the Contractor from any risk or from fulfilling all terms of the Contract.

## **2.6. PROJECT SITE**

### **2.6.1 Project Site Description**

The Project Site is CAWC's Fitch Park ASR Facility located on former Fort Ord in Seaside, California.

Access to the sites is from General Jim Moore Blvd. It will be the responsibility of the Contractor to inspect the sites and make provisions for physically moving onto and off of the sites with personnel, equipment, supplies, and materials.

### **2.6.2 Project Site Preparation**

CAWC does intend to perform Project Site preparation work prior to entering into the Contract with the Contractor. The Project site work will include the drilling of both new wells, which work is not included as part of this RFP.

### **2.6.3 Project Site Access during the Proposal Period**

Each Proposer should, at its own cost and expense, visit the Project Site and become familiar with and be satisfied as to the general, local, and Site conditions that may affect cost, progress, and performance of the Work. Proposers may only access the Project Site that are situated on private property after obtaining written authorization from CAWC or the private property owner and may be required to enter into a site access agreement with CAWC or the private property owner as a condition of such authorization.

Upon request, CAWC may provide an optional tour of the Project area to Proposers. If provided, CAWC will send written notification of the meeting location and other logistical information following a request for tour. During the tour, Proposers may ask questions limited to those regarding the Project Site, and CAWC may provide responses. All such questions will be recorded by CAWC personnel, and any responses will be issued in writing in an addendum to all Proposers. Only official addenda issued by CAWC are binding.

## **2.7. SCOPE OF WORK**

The required scope of Work is set forth in detail in the draft Contract and is summarized in Section 2.7.3 and below.

### **2.7.1 Basic Performance Requirements**

The Contract will require the Contractor to provide a quality assurance and quality control plan prior to beginning the construction of the Project and adhere to that plan during construction. In performing the Work, the Contractor shall comply with the Contract, which includes all requirements of applicable law.

### **2.7.2 Environmental Compliance**

The Contractor will be required to conduct its construction activities consistent with the requirements of the attached technical specifications.

### **2.7.3 Design and Construction**

The Contractor will have full responsibility for design and construction of the Project, including safety of the Project Site and the Work and all means and methods of design and construction.

The Contractor will be required to be AVETTA green flag certified prior to execution of the Contract with CAWC. AVETTA is a third party safety program auditing firm that CAWC uses to evaluate contractor safety programs. There is a fee associated with AVETTA membership that is the responsibility of the Contractor. To sign up or learn more, Proposers may visit the following web-site: <https://www.avetta.com/>

The Contractor will be required to perform all Work in compliance with the Contract, including all environmental and other stipulations, conditions and mitigation requirements set forth in the various requirements and permits, approvals and grants of rights to CAWC property access and use. The Contractor will be required to provide for the observation of its Work by CAWC and regulatory agencies. All Work will be required to conform to the requirements set forth in the draft Contract.

### **2.7.4 Acceptance Testing**

The Contractor will be required to successfully complete acceptance testing of the Project as set forth in the draft Contract.

### **2.7.5 Quality Management**

To help ensure a comprehensive and effective construction quality management plan is implemented by the Contractor to achieve CAWC objectives and that the contractual requirements pertaining to quality are met, certain minimum requirements for the construction quality control are set forth in the draft Contract. The Contractor must provide a construction quality management plan meeting the minimum requirements of the Contract prior to beginning construction.

### **2.7.6 Operation and Maintenance Training**

The Contractor will be required to train CAWC employees prior to substantial completion, as described in the draft Contract and Technical Specifications.

## **2.8. DRAFT CONTRACT**

### **2.8.1 Purpose and Scope**

The scope of work described in this section is reflected in the draft Contract. The draft Contract shall serve as the intended form of the contract between CAWC and the Contractor. Specific

**Monterey Peninsula Water Supply Project  
Request for Proposals  
Design Build of Fitch Park ASR Wells 5 and 6 Above Ground Facilities**

information from the selected Proposal(s) will be incorporated into the final Contract including, but not limited to, pricing and the Contract Times.

The Contract will contain the entire agreement between the parties with respect to the Work.

### **2.8.2 Proposed Changes to the Draft Contract**

Proposers may request changes to the terms and conditions of the draft Contract (excluding technical specifications and drawings) in writing and submitted with their Proposal.

CAWC requests Proposers to base their Proposals on the terms and conditions set forth in the draft Contract as amended by any addendum. Acceptance of the terms and conditions of the draft Contract will be a factor in the evaluation of Proposals, as detailed under Section 5 of this RFP. CAWC recognizes, however, that Proposals may be conditioned on the mutual resolution of particular issues.

To the extent that a Proposer intends to condition its Proposal on particular changes to the draft Contract, such changes shall be identified through submission of a markup version of the draft Contract in a Microsoft Word document using track changes. Proposers are cautioned that significant deviations from the terms and conditions set forth in the draft Contract may result in fewer or no points being awarded to the Proposer under the business terms and conditions evaluation criterion. In addition, to the extent that proposed changes to the terms and conditions substantially change the nature of the transaction or the scope of Work, CAWC may reject the Proposal in its sole discretion as non-responsive to the requirements of this RFP.

In evaluating proposed terms and conditions, CAWC will assume that the Proposer's markup includes all suggested changes and that the Proposer accepts all terms and conditions that are not specifically addressed in the tracked changes draft. Except with respect to changes in law occurring between the Proposal date and the effective date of the Contract, CAWC does not intend to discuss or negotiate any issue, term or condition that is not specifically identified in the Proposer's markup. If the Proposer selected for negotiations raises any such issue, term or condition, CAWC reserves the right to suspend or terminate negotiations with the selected Proposer and to commence negotiations with the next highest ranked Proposer. The process for the negotiation of the Contract is further described in Section 3.11 of this RFP.

### **2.9. UTILIZATION OF DIVERSE BUSINESS ENTERPRISES**

CAWC acknowledges the contributions of women, minority and disabled veteran business enterprises ("WMDVBE") to California's economy, in part, through CPUC General Order 156. In accordance with CPUC General Order 156, CAWC is committed to promote and facilitate full participation in these programs.

Proposers must prepare and submit a Diverse Business Enterprise Requirement Statement as part of its response to this RFP. The Diverse Business Enterprise Requirement Statement is a written commitment to contract with diverse businesses that have been certified through the CPUC's Supplier Clearinghouse, as part of the Project.



**Monterey Peninsula Water Supply Project  
Request for Proposals  
Design Build of Fitch Park ASR Wells 5 and 6 Above Ground Facilities**

CAWC will require that the Contractor monitor and report the continued implementation of the diverse business program goals, as stated in the Diverse Business Enterprise Requirement Statement, throughout performance of the Contract.

## **2.10 UTILIZATION OF LOCAL CONTRACTORS AND SUPPLIERS**

CAWC acknowledges the benefit that the local community receives through utilization of local contractors, laborers, and suppliers.

Proposers must prepare and submit a local resources utilization and reporting plan (“Local Resources Utilization Plan”) as part of its response to this RFP. The Local Resources Utilization Plan is a written commitment to contract with local contractors, subcontractors, sub-consultants, vendors, suppliers, and labor forces. The Contractor will be required to make a good faith effort to employ qualified individuals who are, and have been for at least one year out of the three years prior to the opening of Proposals, residents of Monterey County, San Benito County, or Santa Cruz County in sufficient numbers so that no less than fifty percent (50%) of the Contractor’s total construction work force, including any Subcontractor work force (with exception of specialty subcontractor items), measured in labor work hours, is comprised of residents of such counties.

CAWC will require that the Contractor monitor and report the continued implementation of the Local Resources Utilization Plan throughout performance of the contract.

## **2.11 LABOR COMPLIANCE AND PREVAILING WAGE**

Proposers must comply with all applicable requirements of the California Labor Code, the Department of Fair Employment and Housing regulations set forth in CCR, title 2, sections 8101 *et seq.* Proposer Nondiscrimination and Compliance (2 CCR §§ *et seq.*), and with all applicable federal labor requirements. See attached Exhibit A – *DBE Good Faith Efforts Requirements*, and Exhibit B - *Davis Bacon Contract Provisions*, both of which will be incorporated into any contract executed pursuant to this RFP.

CAWC has the responsibility for financing the Project. CAWC anticipates that a portion of the funding will come from the State’s revolving loan program. Prevailing wages must be paid on projects receiving such funding. Proposers, therefore, will be required to pay prevailing wages.

Pursuant to Section 1773 of the California Labor Code, the general prevailing wage rates in the county in which the construction is to be performed is determined by the Director of the California Department of Industrial Relations (“DIR”). The general prevailing wage rates for this Project are available from the DIR’s website at <http://www.dir.ca.gov>.

The Project may be subject to a statutory requirement to adopt and enforce a labor compliance program for the monitoring and enforcement of prevailing wage requirements.

## **2.12 EQUAL EMPLOYMENT OPPORTUNITY**

Proposers shall not, in connection with the RFP, the Proposal or the Contract, discriminate against any employee or applicant for employment on the basis of race, color, religion, sex, national origin,

**Monterey Peninsula Water Supply Project  
Request for Proposals  
Design Build of Fitch Park ASR Wells 5 and 6 Above Ground Facilities**

age, marital status or disability. Proposers shall take affirmative action to ensure that neither employees nor applicants for employment are discriminated against on the basis of race, color, religion, sex, national origin, age, marital status, ethnic group identification, sexual orientation, residence or disability. The areas requiring such affirmative action shall include, but not be limited to, the following: layoffs or terminations; pay rates or any other form of compensation; employment; job assignments; promotions; demotions; transfers; recruitment or recruitment advertising; and selection for training, including apprenticeships, pre-apprenticeships and on-the-job training.

## **2.13 LICENSING REQUIREMENTS**

Proposers, including all major participants of a Proposer's team, shall possess all licenses applicable to the Project at the time of Proposal submittal. No Proposer may propose on work of a kind for which Proposer is not properly licensed, and any such proposal received will be rejected. The Proposal shall contain evidence that the Proposer, including all major participants, is properly licensed in accordance with the laws of the State of California. Subcontractors that are not major participants must be licensed no later than the time of execution of a subcontract with the Contractor. All joint ventures must have a joint venture license in compliance with Sections 7029 and 7029.1 of the California Business and Professions Code prior to execution of the Contract.

## **2.14 EXAMINATION OF CONTRACT DOCUMENTS AND PROJECT SITE**

### **2.14.1 Proposer's Responsibilities**

It is the responsibility of each Proposer before submitting a Proposal to:

1. Examine, with appropriate care and diligence, the RFP (including any addenda), and inform itself with respect to any and all conditions that may in any way affect the amount or nature of its Proposal or the performance of the Work, if Proposer enters into the Contract with CAWC. The Transmittal Letter (Proposal Form 1) includes an acknowledgment that Proposer has received and reviewed all materials posted thereon. Any failure of Proposer to so examine and inform itself shall be at Proposer's sole risk, and CAWC will provide no relief for any error or omission thereto;
2. Become familiar with the Project Site and the general, local or other conditions that may affect cost, progress, performance or furnishing of the Work;
3. Become familiar with and satisfy all applicable law that may affect cost, progress, performance or furnishing of the Work; and
4. Promptly notify CAWC of all conflicts, errors, ambiguities, or discrepancies that Proposer has discovered in the RFP.

### **2.14.2 Site Visits**

Proposers may visit the Project Site as described in Section 2.6.3.

**Monterey Peninsula Water Supply Project  
Request for Proposals  
Design Build of Fitch Park ASR Wells 5 and 6 Above Ground Facilities**

**2.15 SECURITY FOR PERFORMANCE**

The Contractor will be required to provide the following security for performance in connection with the Project: payment and performance bonds each in an amount equal to the Contract Price.

**SECTION 3**

**DESCRIPTION OF PROCUREMENT PROCESS**

**3.1. PROCUREMENT PROCESS SCHEDULE**

A summary schedule of the major activities associated with this procurement process is presented below. This procurement schedule is based on CAWC’s intent to execute a Contract to be effective by December 1, 2018.

<b>RFP Process</b>	<b>Date</b>
RFP and draft Contract issued to Pre-qualified Respondents	September 29, 2018
RFP Pre-Proposal meeting	October 11, 2018, 9:00 AM PST
Written questions and comments on RFP and draft Contract due	October 15, 2018
CAWC issues addendum to RFP, with revised draft Contract if any, and distributes answers to written questions	October 18, 2018
Project Proposals due	October 25, 2018
Selection of preferred Proposer(s)	November 1, 2018
Final draft Contract and all Proposals to Governance Committee for recommendation	November 2018
Governance Committee meeting	November 2018
Contract execution	TBD

Proposers are encouraged, but not required, to submit written questions or comments on the RFP or draft Contract in advance of the pre-Proposal meeting with CAWC in order to facilitate discussion. Where written comments or submittals are required, all such documents shall be submitted no later than 3:00 p.m. PST on the day specified. CAWC reserves the right to modify any or all of the above dates at its sole discretion at any time during this procurement process.

**3.1.1 Pre-Proposal Meeting**

As set forth in the schedule included in Section 3.1 above, CAWC will hold a pre-Proposal meeting at the address listed in 3.6 with all qualified Proposers. This meeting is intended to, among other things, allow Proposers to raise questions or comments on the RFP or draft Contract. Following the meeting, CAWC will issue an addendum to reflect any changes to the RFP or draft Contract. Proposers are encouraged to submit information regarding any proposed changes at least three business days in advance of the meeting in order to maximize the value of the discussions at the meeting.

### **3.2. SELECTION COMMITTEE**

The Selection Committee, which is comprised of individuals selected by CAWC, will review and evaluate the Proposals submitted and select the most advantageous Proposer(s) based upon the criteria detailed in Section 5 of this RFP.

### **3.3. CAWC RIGHTS AND OPTIONS**

This RFP constitutes an invitation to the Pre-qualified Respondents to submit Proposals to CAWC. CAWC reserves, holds without limitation and may exercise, in its sole discretion, the rights as set forth below. Such rights are in addition to and shall not serve to limit any of the specific rights and conditions set forth in this RFP. By responding to this RFP, Proposers acknowledge and consent to the following CAWC rights:

1. CAWC reserves the right to waive any defect, technicality or any other minor informality or irregularity in any Proposal.
2. CAWC reserves the right to eliminate any Proposer that submits an incomplete or inadequate response, or is not responsive to the requirements of this RFP, or is otherwise deemed to be unqualified during any stage of the procurement process.
3. CAWC reserves the right to prepare and issue such amendments and addenda to this RFP prior to the deadline for receipt of all Proposals, including any amendments or addenda that may expand or cancel any portion or all of the work described in this RFP.
4. CAWC reserves the right to receive questions concerning this RFP from Proposers and to provide such questions, and CAWC's responses, if any, to all Proposers.
5. CAWC reserves the right to request clarifications of information submitted in the Proposals.
6. CAWC reserves the right to modify or terminate the procurement process by written notice to the Proposers for any reason whatsoever.
7. CAWC reserves the right to change or alter the schedule for any events associated with this procurement process upon notice to the Proposers, including, without limitation, the date for receipt of Proposals or any other deadlines and dates set forth in this RFP.
8. CAWC reserves the right to issue subsequent RFPs.
9. CAWC reserves the right to conduct investigations with respect to the experience of any team member included in a Proposal and to request additional evidence to support any such information.

**Monterey Peninsula Water Supply Project  
Request for Proposals  
Design Build of Fitch Park ASR Wells 5 and 6 Above Ground Facilities**

10. CAWC reserves the right to visit and examine any of the facilities referenced in the Proposals or SOQs and to observe and investigate the operations of such facilities.
11. CAWC reserves the right to interview one or more of the Proposers, in CAWC's sole discretion, in order to obtain clarification of information provided by the Proposer.
12. CAWC reserves the right to amend the Work described in the draft Contract, at any time, to omit Work therein or to include Work not currently contemplated therein.
13. CAWC reserves the right to determine the selected Proposer(s) with whom to negotiate the Contract.
14. CAWC reserves the right to discontinue negotiations with the selected Proposer(s) and commence negotiations with the next ranked Proposer(s).
15. CAWC reserves the right to enter into, or decline to enter into, the Contract with the selected Proposer(s) following negotiations.
16. CAWC reserves the right, for any reason, to decide not to award a Contract as a result of this procurement process.
17. CAWC reserves the right to decide on the most appropriate method for Project implementation, which may include discontinuation of this procurement process and development of the Project via another process elected by CAWC.

**3.4. EXPENSE OF PROPOSAL PREPARATION**

CAWC accepts no liability for the costs and expenses incurred by the Proposers in responding to this RFP, responding to clarification requests and attending discussion meetings, preparing any re-submittals, attending potential interviews and negotiations, and any other activities included as part of this procurement process. Each Proposer that enters into the procurement process shall prepare the required materials and submittals at its own expense and with the express understanding that it cannot make any claims whatsoever for reimbursement from CAWC or from any of its employees, advisors or representatives for the costs and expenses associated with the process, including, but not limited to, costs of preparation of the Proposal, loss of anticipated profits, loss of opportunity or for any other loss, cost or expense.

**3.5. ADDENDA TO RFP**

During the period provided for the preparation of Proposals, CAWC may issue addenda clarifying or modifying this RFP. Such addenda will be numbered consecutively and will be distributed to each Proposer's duly designated Proposal Manager. All RFP addenda will be issued by, or on behalf of, CAWC and will constitute a part of this RFP. A list of addenda will be kept on the MPWSP Website. CAWC recommends that prior to submitting its Proposal, a Proposer should contact the Procurement Contact (defined below) to verify the number and subject of the addenda

**Monterey Peninsula Water Supply Project  
Request for Proposals  
Design Build of Fitch Park ASR Wells 5 and 6 Above Ground Facilities**

that have been issued. The Proposer shall be responsible for obtaining all addenda prior to submitting a Proposal.

### **3.6. COMMUNICATIONS PROTOCOL**

To ensure fairness during the procurement process, until the Contract is executed or all Proposals are rejected, Proposers and their employees, representatives and agents shall not contact any CAWC employee (other than the Procurement Contact); any County of Monterey official, representative or staff member; any Monterey Peninsula Regional Water Authority official, representative, technical advisory committee member or staff member; or any Monterey Peninsula Water Management District official, representative or staff member on any matter relating to the Project, the MPWSP or this procurement process. Proposers, however, may contact, discuss with, or inquire of any permitting agency, including those identified above, about the Project or the MPWSP but only for the limited purpose and within the limited scope of obtaining information relating to the permitting requirements for the Project. Failure to adhere to these requirements may result in disqualification from the procurement process.

All formal questions regarding interpretations or clarification of the meaning of any part of this RFP or other documents provided by CAWC shall be made in writing or by email to Jay Drewry (the "Procurement Contact") at the following address:

CALIFORNIA AMERICAN WATER  
511 FOREST LODGE ROAD, SUITE 100  
PACIFIC GROVE, CA 93950  
Attn: Jay Drewry, Senior Buyer  
[jay.drewry@amwater.com](mailto:jay.drewry@amwater.com)

The Proposers shall submit questions and requests for clarifications no later than 5:00 p.m. PDT on the date indicated in Section 3.1 of this RFP. All questions and clarification requests shall be in writing, and Proposers are encouraged to submit such questions and clarification requests in advance of the above deadline. Only answers issued by formal written addenda or as posted on the MPWSP Website shall be binding upon CAWC. Oral and other interpretations or clarifications shall not be binding and Proposers shall not rely on any such responses.

### **3.7. USE OF TECHNICAL INFORMATION**

By submitting a Proposal, Proposers agree that regardless of whether CAWC awards the Contract, CAWC shall have the right to use (or permit the use of) all information submitted pursuant to this RFP, including the data, information, concepts and ideas contained therein, without any requirement of providing compensation to the Proposer, for all purposes associated with the continued development, implementation, or operation of the Project. Notwithstanding the foregoing, other than the use of data, information, concepts and ideas contained in the selected Proposer's Proposal for the Project, CAWC agrees that any such use of Proposals by CAWC without the applicable Proposer's consent shall be at the sole risk of CAWC.

### **3.8. INFORMATION DISCLOSURE TO THIRD PARTIES**

Per section V(D) of the Governance Committee Agreement, at the appropriate time CAWC will provide the Governance Committee a copy of all responsive Proposals received, except for any proprietary information provided by Proposers submitting responsive Proposals. This may be accomplished by posting the Proposals on the MPWSP Website. If a Proposer identifies proprietary information in its Proposal, CAWC will use reasonable efforts to hold in confidence such proprietary information. Notwithstanding the foregoing, CAWC will not be responsible or liable in any way for any losses that the Proposer may suffer from the disclosure of information or materials to third parties. Any proposed pricing shall not be considered proprietary information.

CAWC will notify the Proposer of any requests under applicable law to disclose any information identified by a Proposer as proprietary. However, it is the responsibility of the Proposer, as the real party in interest, to defend its basis for exemption from disclosure of such information in accordance with applicable law.

### **3.9. PRIOR EXPERIENCE**

In order for offers to be considered responsive Proposers must meet these minimum prior experience requirements:

- Proposer shall have completed at least 2 design-build projects during the past 3 years of similar size and scope in nature as the projects specified herein.
  - Provide references including contact information for at least two projects referenced.
- Be properly licensed and provide evidence your firm can perform this work within the State of California.

An offeror's failure to meet these minimum prior experience requirements may cause their proposal to be considered non-responsive and their proposal may be rejected.

### **3.10. EVALUATION AND RANKING OF PROPOSALS**

The Selection Committee will evaluate the Proposals in the manner set forth in Section 5 of this RFP. The results of the evaluation will be a selection of the most advantageous Proposer.

The Selection Committee will: (i) review the Proposals; and (ii) rank the Proposals using the criteria detailed in Section 5 of this RFP.

The evaluation of the technical and financial qualifications shall be based on the Proposals received in compliance with this RFP and an analysis of other publicly available information with respect to the Proposers. CAWC may conduct such investigations, interviews, and site visits as it deems necessary to assist in the evaluation of any Proposal, and to establish to CAWC's satisfaction with the responsibility, qualifications, and financial ability of any Proposer.



**Monterey Peninsula Water Supply Project  
Request for Proposals  
Design Build of Fitch Park ASR Wells 5 and 6 Above Ground Facilities**

**3.11. NEGOTIATION OF CONTRACT**

The Proposer(s) selected for negotiations shall be determined based upon the evaluation and ranking of the Proposals by the Selection Committee consistent with the requirements set forth in this RFP.

Proposers are reminded that, pursuant to Section 2.8 of this RFP, acceptance of any suggestions included in the Proposer's mark-up of the draft Contract submitted by the Proposer is at CAWC's sole discretion and that CAWC does not intend to discuss or negotiate any issue, term or condition that is not specifically identified therein. At any time during the negotiation process, CAWC may decide that it is in CAWC's best interests to terminate negotiations with the selected Proposer(s). In such event, CAWC may elect to commence negotiations with the next highest ranked Proposer(s), to terminate this procurement, or to re-solicit proposals under this, or a different, RFP. As shown on the schedule set forth in Section 3.1, CAWC does not intend to have an extended period of negotiation.

Following the negotiation of the Contract(s) and review of the Contract(s) by the Governance Committee pursuant to the Governance Committee Agreement, CAWC intends to execute the Contract(s).

## **SECTION 4**

### **PROPOSAL REQUIREMENTS**

#### **4.1. OVERVIEW OF SUBMISSION REQUIREMENTS AND CRITERIA FOR PROPOSALS**

Proposers shall submit a fully developed Proposal in accordance with the instructions provided in this Section.

Proposals shall meet or exceed the construction requirements provided in the Contract.

Proposers shall provide the information requested in this RFP in accordance with the format and content requirements outlined in this Section. Failure of the Proposer to provide all of the requested information and to provide it in the requested format may result in CAWC, in its sole discretion, determining that the Proposal is non-responsive to the requirements of this RFP.

#### **4.2. PROPOSAL FORMAT**

Each Proposal shall be spiral bound (or similar, such as 3-ring binders) and shall consist of four sections in accordance with the format outlined below. Narrative pages shall be 8-1/2 inches by 11 inches, printed single or double sided and typed with a minimum 11-point font (unless otherwise stated). Diagrams and figures may be printed on 11-inch by 17-inch paper. All descriptive text on diagrams and figures must be easily readable; 10-point font is acceptable as long as it is easily readable. Proposers shall incorporate graphics (*e.g.*, process flow diagrams and drawings) as necessary to clearly present their Proposals. A clear and concise presentation of information is encouraged within the size limitations established for the Proposal. Proposals shall be in the English language.

Failure of the Proposer to organize the information as required by this Section of this RFP may result in rejection of the Proposal by CAWC, in its sole discretion, deeming the Proposal unresponsive to the requirements of the RFP. Proposers may reduce the repetition of identical information within the several sections of Proposals by making the appropriate cross-references to other sections of their Proposals and Proposal Forms.

The complete Proposal format requirements are outlined as follows:

#### **Section 1.0 Executive Summary**

- A.** Proposal Form 1: Transmittal Letter
- B.** Executive Summary
- C.** Proposal Form 2: Non-Collusion Affidavit
- D.** Proposal Form 3: Disclaimer Statement

**Section 2.0 Project Team Information**

- A. General Design Team Information
- B. General Construction Project Team Information
- C. Proposal Form 4: Key Personnel
- D. WMDVBE Utilization Plan
- E. Local Resources Utilization Plan

**Section 3.0 Technical Proposal**

- A. Proposal Form 5: Preliminary Project Schedule, Design Schedule, Scheduled Construction Date, and Scheduled Acceptance Date
- B. Plan for Acceptance Testing

**Section 4.0 Business and Price Proposal**

- A. Summary of Business and Price Proposal
- B. Proposal Packages
- C. Proposal Form 6: Acceptance of Contract
- D. Proposal Form 7: Price Escalator Indices
- E. Proposal Form 8: Diverse Business Enterprise Requirement Statement

**4.3 PROPOSAL SUBMISSION**

**4.3.1. Proposal Deadline**

All Proposals, including all attachments, shall be delivered in a sealed package addressed to:

CALIFORNIA AMERICAN WATER  
511 FOREST LODGE ROAD, SUITE 100  
PACIFIC GROVE, CALIFORNIA 93950  
Attn: Jay Drewry, [jay.drewry@amwater.com](mailto:jay.drewry@amwater.com)

The Proposal shall include the following information on the outside of the envelope(s) or box(es): (1) Name of Proposer and (2) "Proposal for ASR Wells 5 & 6 of the Monterey Peninsula Water Supply Project". Proposals will not be opened publicly.

The Proposals, including applicable Proposal Forms, shall be signed and acknowledged by the Proposer in accordance with the instructions herein. Proposals shall be delivered to and be

**Monterey Peninsula Water Supply Project  
Request for Proposals  
Design Build of Fitch Park ASR Wells 5 and 6 Above Ground Facilities**

received by CAWC at the above address **on or before 3:00 pm Pacific Time on October 25, 2018**. Any Proposal received after that time may be returned unopened to the Proposer.

**4.3.2. Number of Copies**

At least one original signed copy. All Proposals shall be complete with all requested information, data and attachments. If more than one copy is provided, the original copy of the Proposal must be clearly marked as the original and must contain the original signature forms and other original documents. The remaining copies of the Proposal may be reproductions and Proposers shall number each hard copy in sequential order on the upper right corner of each cover.

**4.4. PROPOSAL CONTENTS**

The Proposer shall provide the appropriate information in accordance with the content and format requirements set forth in each of the following submission subsections.

Proposers are advised that, if selected, as part of the Contract negotiation phase, portions of the information contained in its Proposal will be included or integrated into the Contract, as negotiated by the parties based on the RFP and Proposal.

**4.4.1. Section 1.0: Executive Summary**

**A. Proposal Form 1: Transmittal Letter**

Each Proposal must include one fully executed and notarized Transmittal Letter from the Proposer acknowledging, among other things, that the Proposer has completely reviewed and understands and agrees to be bound by the requirements of this RFP and has received all addenda. Such letter commits the Proposer, if selected, to carry out the provisions of the Proposal. The Transmittal Letter shall be submitted on the Proposer's letterhead in the form of Proposal Form 1 and signed by a representative of the Proposer who is empowered to sign such material and to commit the Proposer to the obligations contained in the Proposal (the "Designated Signatory"). The Certificate of Authorization (Attachment 1 to the Transmittal Letter) attesting to such authorization must also be submitted with the Transmittal Letter. If the Proposer is a partnership, the Proposal shall be signed by one or more of the general partners. If the Proposer is a corporation, an authorized officer shall sign his or her name and indicate his or her title beneath the full corporate name. If the Proposer is a joint venture, each firm in the joint venture shall sign the Transmittal Letter. If the Proposer is a limited partnership or a limited liability company, the Proposal shall be executed by the managing partner(s) or managing member thereof. Anyone signing the Proposal or any Proposal Form as agent must file with it legal evidence of his or her authority to execute such Proposal or Proposal Form. The Designated Signatory shall sign all forms that require the signature of the Proposer. The Transmittal Letter must also contain a listing of all firms that are part of the Proposer's Project team (Attachment 2 to the Transmittal Letter) and a listing of all applicable licenses (Attachment 3 to the Transmittal Letter). A summary of the role for each member of the Proposer's Project team shall be included.

**B. Executive Summary**

The Proposer shall submit an executive summary detailing the key aspects of the Proposal. The executive summary should include a clear statement of the Proposer's understanding of the RFP, identify the Proposer's key team members and their respective roles with respect to the proposed Project, briefly describe the proposed processes, and summarize the other significant aspects of the Proposal noting how the Proposer meets the requirements of the RFP and the Contract. The executive summary shall include the following charts and diagrams:

- Project Team (8½" x 11", 1 page)
- Preliminary Proposed Staging Plan (11" x 17", 1 page)

**C. Proposal Form 2: Non-Collusion Affidavit**

Proposers shall complete and sign Proposal Form 2, which acknowledges that the Proposal has been made and submitted in good faith and without collusion or fraud.

**D. Proposal Form 3: Disclaimer Statement**

Proposers shall be responsible for independently verifying the accuracy of all the information contained in the RFP. Proposers shall complete and sign Proposal Form 3 which releases CAWC and CAWC Representatives (as defined therein) from any and all claims arising from any information contained in or otherwise provided in connection with this RFP, except as otherwise specifically provided in the Contract.

**4.4.2. Section 2.0: Project Team Information**

**A. General Project Team Information**

The Proposal shall include a description of the Proposer, *i.e.*, the form of business structure (corporation, partnership, joint venture, etc.) that is proposed to serve as the contracting party. A Project organization chart is required which shall include a full-page diagram of the legal relationships between all parties of the Proposer's Project team and a clear description of the ownership structure of all Project team members. If the Proposer is a partnership or a joint venture, all members of the Proposer shall be listed.

The Proposal shall identify the portions of the Project that will be undertaken directly by the Proposer and what portions of the Project will be subcontracted and to which firms (collectively, "Significant Subcontractors"). The Project organization chart shall also show all Key Personnel (identified on Proposal Form 4, below) and lines of authority.

The Proposer shall also identify any other entity, including, without limitation, any corporation, partnership, firm, joint venture, or individual to which the Proposer intends to assign material responsibilities under the Contract. At a minimum, the Proposal shall identify the parties that will undertake the various roles required to perform the Work.

**Monterey Peninsula Water Supply Project  
Request for Proposals  
Design Build of Fitch Park ASR Wells 5 and 6 Above Ground Facilities**

The proposed contractual relationships between the Proposer and all major partners and Significant Subcontractors relative to the various phases of the Project (*e.g.* construction, commissioning) shall be outlined in the Proposal. CAWC reserves the right to request copies of such contracts as part of the Proposal review process.

In addition, Proposers shall indicate the current workload of the key Project team members and shall provide a description of how the Project team will manage the workload in a manner that will assure the timely, cost-effective delivery of the Work.

**B. Proposal Form 4: Key Personnel**

The Proposer shall complete Proposal Form 4 for all Key Personnel, which shall include the following individual team members (as applicable):

1. Executive and Program Leadership;
2. Overall Design Team with Design Team Leader;
3. Overall Project Manager;
4. Construction Superintendent;
5. Safety Manager;
6. QA/QC Manager;
7. Commissioning Manager.

Additional forms may be provided for other Key Personnel critical to completion of the Project. Where one individual or team member performs several functions, information shall be provided on immediate subordinates. The Proposers shall demonstrate that the Key Personnel include the appropriate mix of skills and disciplines, that there shall be assurance of continuity throughout performance of the Work, and that there is definitive authority vested in the appropriate individuals to fully execute the Project. The Proposer shall submit a statement attesting to the Proposer's commitment to keep the individuals so identified for the duration of the intended role in the Project for each individual. This commitment is to last as long as each individual remains in the employ of the Proposer, subject only to unavoidable personal circumstances affecting the Key Personnel. The Proposal shall identify where Key Personnel will be located during the execution of the Project.

**C. Diverse Business Enterprise Utilization Plan**

As described in Section 2.9 of this RFP, Proposers must prepare and submit a Diverse Business Enterprises Requirement Statement as part of its Proposal on the attached Diverse Business Enterprises Requirement Statement (Proposal Form 8). The Diverse Business Enterprises Requirement Statement is a written commitment to contract with Diverse Business Enterprises that have been certified through the CPUC's Supplier Clearinghouse, as part of the Project.

**Monterey Peninsula Water Supply Project  
Request for Proposals  
Design Build of Fitch Park ASR Wells 5 and 6 Above Ground Facilities**

CAWC will require that the Contractor monitor and report the continued implementation of the Diverse Business program goals, as stated in the Diverse Business Enterprises Requirement Statement, throughout performance of the Contract.

**D. Local Resources Utilization Plan**

As described in Section 2.10 of this RFP, Proposers must prepare and submit a Local Resources Utilization Plan as part of its Proposal. The Local Resources Utilization Plan shall include that the Contractor will make a good faith effort to employ qualified individuals who are, and have been for at least one year out of the three years prior to the opening of Proposals, residents of Monterey County, San Benito County, or Santa Cruz County in sufficient numbers so that no less than fifty percent (50%) of the Contractor's total construction work force, including any Subcontractor work force (with exception of specialty subcontractor items), measured in labor work hours, is comprised of residents of such counties. CAWC will require that the Contractor monitor and report the continued implementation of the Local Resources Utilization Plan throughout performance of the Contract.

**E. Section 3.0: Technical Proposal**

This section of the Proposal shall present the technical aspects of the Proposer's plan to provide the Work. Each Proposer shall provide a description of the proposed Project and the information necessary to convey a clear understanding of the proposed systems and equipment, as well as a description of the approach to the performance of the Work in accordance with the requirements set forth in this Section. The Proposer's technical submission shall be in sufficient detail so that CAWC can ascertain the Proposer's ability to comply with the performance and quality level requirements set forth in the draft Contract. The organization of the technical information submitted shall be in a format that can be easily incorporated into the final Contract.

**F. Preliminary Project Schedule, Scheduled Construction Date, and Scheduled Acceptance Date**

The Proposer shall provide a list of proposed major milestones, durations and completion dates for major activities important to procurement, permitting, construction, and commissioning activities in Proposal Form 5. The list shall start with the effective date of the Contract and end upon final completion and shall clearly indicate the extent to which the Proposer has included float in the schedule. These major milestones, activity durations, and completion dates will comprise the preliminary Project schedule. The Proposer shall provide copies of this preliminary Project schedule in both written and electronic formats with the Proposal. The level of detail shall be summary level for major procurement, construction, commissioning and acceptance testing activities in accordance with the requirements specified in Proposal Form 5.

**G. Plan for Acceptance Testing**

The Proposal shall describe the Proposer's approach for making the transition from the Work to the warranty period under the Contract. The Proposer shall provide an overview of its approach for the transition in its Proposal as such transition plans may not be finalized. Requirements for commissioning and for training of CAWC's staff are in the draft Contract.

**4.4.3. Section 4.0: Business and Price Proposal**

This section of the Proposal shall present the business and pricing aspects of the Proposal. While CAWC anticipates entering into the Contract with the selected Proposer(s) in accordance with the schedule set forth in Section 3 of this RFP, it is possible that the execution of the Contract will be delayed due to unforeseen circumstances. The following subsections outline the information that shall be included in the Proposer's business and price submission.

**A. Summary of Business and Price Proposal**

Proposers shall provide a summary of the key aspects of its business and price proposal with reference to the applicable Proposal Forms and bid packages, including the bid packages discussed below and the Proposal Forms required above with respect to the financial capacity of the Proposer.

**B. Attachment C: Proposal Packages**

Attachment C consists of the Proposal package. The Proposal package prices shall include all costs for performing the design and corresponding construction Work. The proposal package prices shall also include the costs associated with the required insurance, performance and material payment bonds, as well as any other costs associated with the Work necessary to achieve final completion. Proposers shall propose their proposal package prices with the understanding that CAWC may or may not request further "best and final offers." The total Contract Price and each line item price shall be inclusive of all applicable taxes (including California sales taxes on purchases of materials at the applicable tax rate). The Contractor will be responsible for paying all such taxes in accordance with applicable law.

**C. Proposal Form 6: Acceptance of Contract**

The Proposer shall complete Proposal Form 6 by agreeing to all of the terms and conditions of the draft Contract except for those suggested changes submitted as an attachment to Proposal Form 11. As indicated in Section 2.8.2 of this RFP, while CAWC requests Proposers to base their Proposals on the terms and conditions set forth in the draft Contract included with this RFP, CAWC recognizes that Proposals may be conditioned on the mutual resolution of specific issues identified in Proposal Form 6. Any requested changes that are conditions of the Proposal must be clearly identified as such. Please refer to Sections 2.8 and 3.11 of this RFP for a discussion concerning CAWC's expectations concerning the Contract and the negotiation process.

**D. Proposal Form 7: Price Escalator Indices**

The Proposer agree to use the process outlined in Proposal Form 7.

**E. Proposal Form 8: Diverse Business Enterprise Requirement Statement**

The Proposer shall complete Proposal Form 8 page 2 by answering question 1, inserting the percentage in item 2, and filling in the information requested on the lines provided.



**Monterey Peninsula Water Supply Project  
Request for Proposals  
Design Build of Fitch Park ASR Wells 5 and 6 Above Ground Facilities**

**4.5. PROPOSAL FORMS GENERALLY**

To be deemed responsive to this RFP, Proposers shall provide all the requested information and complete all details provided in the Proposal Forms attached to this RFP. All Proposal Forms shall be completed in ink or typewritten and submitted in accordance with the instructions set forth in this Section 4 of this RFP. The Proposal Forms require Proposer-specific information to be inserted in order to be properly completed. Once the Proposer is selected, certain Proposal-specific information submitted in their Proposal and the Proposal Forms may be included as part of the Contract, as appropriate.

**5.**

**EVALUATION OF PROPOSALS**

**5.1. EVALUATION OF PROPOSALS**

Proposals will be evaluated by the Selection Committee based on the Proposer’s ability to meet the performance requirements of this RFP and the Contract in a cost-effective manner. All Proposals must be complete and in conformance with the submission requirements established in this RFP.

Proposals will first be individually evaluated for completeness and for conformance with the requirements set forth in this RFP. Any Proposal that the Selection Committee determines is incomplete or otherwise not in conformance with the submission requirements of this RFP may be deemed non-responsive and thereby rejected in its entirety by the Selection Committee. Alternatively, in its discretion, CAWC may request that a Proposer submit any information necessary to make its Proposal complete and/or in conformance with requirements. Proposals deemed responsive and in conformance with the submission requirements of this RFP will be evaluated by the Selection Committee through the application of the evaluation criteria to the Proposal, as described in Section 5.2 of this RFP.

**5.2. EVALUATION CRITERIA**

The specific criteria to be used by the Selection Committee in the evaluation of the Proposals include both technical criteria and business/financial criteria. Technical criteria are allotted a total of 40 points (out of 100) and include: (1) Project Delivery, (2) Safety, (3) Construction Management, (4) Quality Control, and (5) Schedule each as further detailed below. Commercial terms are allotted a total of 60 points (out of 100) and include (1) Cost Effectiveness (*i.e.*, price) and (2) Business Terms and Conditions, as further detailed below.

**5.2.1. Weighting of Evaluation Criteria**

The specific weighting for each evaluation criterion is as follows:

1)	Technical Submission	30%
2)	Commercial	25%
3)	Schedule & Work Plan	20%
4)	Qualifications and experience	15%
5)	Resources	10%
<b>Total</b>		<b>100 points</b>

### **5.2.2. Technical Criteria**

Proposers shall be evaluated based upon the Proposer's ability to successfully implement the proposed Work and to meet CAWC's desired schedule for the implementation of the Project. The Selection Committee will conduct an assessment of the Proposer's schedule and approach for construction management.

Proposer's approach to project planning, purchasing, coordination of subcontractors, and sequencing and managing the construction activities to meet the schedule will be evaluated, as well as the expertise and management capability to integrate the required expertise of the Project team members for the overall benefit of the Project. Particular attention will also be given to the Proposer's understanding and inclusion in the schedule of the requirements necessary to test equipment, commission the Project, and conduct the acceptance testing.

Safety experience rating for the last three years shall also be considered in this evaluation.

### **5.2.3. Commercial Criteria**

#### **Terms and Conditions**

CAWC will evaluate the extent to which the Proposer accepts the terms and conditions set forth in the draft Contract included with this RFP or otherwise proposes terms and conditions that are more favorable to CAWC than the terms and conditions set forth in the draft Contract. Suggested changes, including, particularly, changes that are indicated to be conditions of the Proposal, will be carefully considered and evaluated to determine whether the suggested changes, taken as a whole, would result in a less favorable Contract to CAWC. Proposers are reminded that proposed changes to the terms and conditions that are conditions of the Proposal and that substantially change the nature of the transaction or the scope of work may result in the rejection of a Proposal as non-responsive to the requirements of this RFP, notwithstanding the relative weight assigned to the proposed business terms and conditions in this RFP.

Proposers will also be evaluated on their Diverse Business Plan and their Local Resources Utilization Plan. CAWC will evaluate the Proposer's approach to avoiding adverse environmental impacts, protecting natural resources, and mitigating environmental impacts. Evaluating the Proposal with respect to Project delivery also includes an assessment of current and projected workloads of the Proposer, and the Proposer's ability to meet the construction schedule for the proposed Project. The Proposer's approach to construction management and scheduling the construction, commissioning, start-up and acceptance test activities will also be evaluated.

**Monterey Peninsula Water Supply Project  
Request for Proposals  
Design Build of Fitch Park ASR Wells 5 and 6 Above Ground Facilities**

**ATTACHMENT A**

**PROPOSAL FORMS**

Proposal Form 1	Transmittal Letter
Proposal Form 2	Non-Collusion Affidavit
Proposal Form 3	Disclaimer Statement
Proposal Form 4	Key Personnel
Proposal Form 5	Preliminary Project Schedule, Scheduled Construction Date, and Scheduled Acceptance Date
Proposal Form 6	Acceptance of the Contract
Proposal Form 7	Price Escalator Indices
Proposal Form 8	Diversity Business Enterprise Requirement Statement

**Monterey Peninsula Water Supply Project  
Request for Proposals  
Design Build of Fitch Park ASR Wells 5 and 6 Above Ground Facilities**

**PROPOSAL FORM 1**

**TRANSMITTAL LETTER**

(to be typed on Proposer's Letterhead)

[Date]

[  
\_\_\_\_\_  
\_\_\_\_\_  
\_\_\_\_\_  
\_\_\_\_\_]

Re: Monterey Peninsula Water Supply Project - Fitch Park ASR Wells 5 and 6 Above Ground Facilities

Dear Sir/Madam:

\_\_\_\_\_ (the "Proposer") hereby submits its Proposal in response to the Request for Proposals for the Monterey Peninsula Water Supply Project Fitch Park ASR Wells 5 and 6 Above Ground Facilities (the "RFP") issued by California-American Water Company ("CAW") on XXXX XX, 2018, as amended.

As a duly authorized representative of the Proposer, I hereby certify, represent, and warrant, on behalf of the Proposer team, as follows in connection with the Proposal:

1. The Proposer acknowledges receipt of the RFP and the following addenda:

<u>No.</u>	<u>Date</u>
_____	_____
_____	_____
_____	_____

- 5.2.3.1.1. The submittal of the Proposal has been duly authorized by, and in all respects is binding upon, the Proposer. Attachment 1 to this Transmittal Letter is a Certificate of Authorization which evidences my authority to submit the Proposal and bind the Proposer.
- 5.2.3.1.2. All information and statements contained in the Proposal are current, correct and complete, and are made with full knowledge that CAW will rely on such information and statements in selecting the most advantageous Proposal to CAW and executing the Contract.
- 5.2.3.1.3. Attachment 2 to this Transmittal Letter sets forth the Proposer's Project team and identifies each team member's proposed role with respect to the Project. Attachment 3 to this Transmittal Letter provides licensing information for each Project team member.

**Monterey Peninsula Water Supply Project  
Request for Proposals  
Design Build of Fitch Park ASR Wells 5 and 6 Above Ground Facilities**

- 5.2.3.1.4. Neither the Proposer nor any Project team member is currently suspended or debarred from doing business in the State of California;
- 5.2.3.1.5. There is no action, suit or proceeding, at law or in equity, before any court or similar governmental body, against the Proposer, wherein an unfavorable decision, ruling or finding would have a materially adverse effect on the ability of the Proposer to perform their respective obligations under the Contract or the other transactions contemplated hereby, or which, in any way, would have a materially adverse effect on the validity or enforceability of the obligations proposed to be undertaken by the Proposer, or any Contract or instrument entered into by the Proposer in connection with the transactions contemplated hereby.
- 5.2.3.1.6. No corporation, partnership, individual or association, officer, director, employee, manager, parent, subsidiary, affiliate or principal shareholder of the Proposer has been adjudicated to be in violation of any state or federal anti-trust or similar statute within the preceding five years, or previously adjudged in contempt of any court order enforcing such laws.
- 5.2.3.1.7. The Proposer and all Project team members have reviewed all of the engagements and pending engagements of the Proposer and all Project team members and no potential exists for any conflict of interest or unfair advantage.
- 5.2.3.1.8. No person or selling agency has been employed or retained to solicit the award of the Contract under an arrangement for a commission, percentage, brokerage or contingency fee or on any other success fee basis, except bona fide employees of the Proposer.
- 5.2.3.1.9. The principal contact person who will serve as the interface between CAW and the Proposer for all communications is:

NAME: \_\_\_\_\_  
TITLE: \_\_\_\_\_  
ADDRESS: \_\_\_\_\_  
  
PHONE: \_\_\_\_\_  
FAX: \_\_\_\_\_  
EMAIL: \_\_\_\_\_

- 5.2.3.1.10. The key technical and legal representatives available to provide timely response to written inquiries submitted and to attend meetings requested by CAW are:

Technical Representative:

NAME: \_\_\_\_\_  
TITLE: \_\_\_\_\_  
ADDRESS: \_\_\_\_\_  
  
PHONE: \_\_\_\_\_  
FAX: \_\_\_\_\_

**Monterey Peninsula Water Supply Project  
Request for Proposals  
Design Build of Fitch Park ASR Wells 5 and 6 Above Ground Facilities**

EMAIL: \_\_\_\_\_  
\_\_\_\_\_

Legal Representative:

NAME: \_\_\_\_\_

TITLE: \_\_\_\_\_

ADDRESS: \_\_\_\_\_  
\_\_\_\_\_

PHONE: \_\_\_\_\_

FAX: \_\_\_\_\_

EMAIL: \_\_\_\_\_  
\_\_\_\_\_

5.2.3.1.11. The Proposer has carefully examined all documents constituting the RFP and the addenda thereto.

5.2.3.1.12. The Contract in the form issued with this RFP is agreed to, except where changes have been requested in Proposal Form 11 and such changes have been indicated as conditions of the Proposal.

5.2.3.1.13. If selected, the Proposer agrees to negotiate in good faith to enter into a Contract that reflects the substantive terms and conditions of the RFP and the Proposal.

5.2.3.1.14. The Proposer has submitted all Proposal Forms and applicable bid packages and such Proposal Forms and applicable bid packages are a part of this Proposal.

Having carefully examined the RFP and all other documents bound therewith, together with all addenda thereto, all information made available by CAW, and being familiar with the Project (as described in the RFP and the Contract) and the various conditions affecting the work, the Proposer hereby offers to furnish all labor, materials, supplies, equipment, facilities and services which are necessary, proper or incidental to carry out such work as required by and in strict accordance with the RFP and the Proposal, all for the prices set forth in the submitted bid packages.

\_\_\_\_\_  
Name of Proposer

\_\_\_\_\_  
Name of Designated Signatory

\_\_\_\_\_  
Signature

\_\_\_\_\_  
Title

**Monterey Peninsula Water Supply Project  
Request for Proposals  
Design Build of Fitch Park ASR Wells 5 and 6 Above Ground Facilities**

*Note: If this Proposal is being submitted by a corporation, the Proposal shall be executed in the corporate name by the president or other corporate officer with authority to bind the corporation, and the corporate seal shall be affixed and attested to by the clerk. A certificate of the secretary of the corporation evidencing the officer's authority to execute the Proposal shall be attached.*

*If this Proposal is being submitted by a joint venture or general partnership, it shall be executed by all partners, and any partner that is a corporation shall follow the requirements for execution by a corporation, as set forth above.*

*If this Proposal is being submitted by a limited partnership or a limited liability company, it shall be executed by the managing partner(s) or managing member thereof, and such shall also submit proof of authority to so execute the Proposal, in a form satisfactory to CAW. Any partner or member that is a corporation shall follow the requirements for execution by a corporation, as set forth above.*

(Use State-Appropriate form for Notary Public)

State of \_\_\_\_\_

County of \_\_\_\_\_

On this \_\_\_\_\_ day of \_\_\_\_\_, 2018, before me appeared [DESIGNATED SIGNATORY], who is [INSERT TITLE] of [INSERT PROPOSER], a [INSERT STATE AND TYPE], personally known to me to be the person described in and who executed this Transmittal Letter and acknowledged that she/he signed the same freely and voluntarily for the uses and purposes therein described.

In witness thereof, I have hereunto set my hand and affixed my official seal the day and year last written above.

\_\_\_\_\_  
Notary Public in and for the State of \_\_\_\_\_  
(Seal)

\_\_\_\_\_  
(Name Printed)

Residing at \_\_\_\_\_

Commission Number \_\_\_\_\_



**Monterey Peninsula Water Supply Project  
Request for Proposals  
Design Build of Fitch Park ASR Wells 5 and 6 Above Ground Facilities**

**Attachment 1**

**CERTIFICATE OF AUTHORIZATION\***

I, \_\_\_\_\_, a resident of [INSERT CITY] in the State of [INSERT STATE], DO HEREBY CERTIFY that I am the Clerk/Secretary of [INSERT PROPOSER NAME], a [corporation] duly organized and existing under and by virtue of the laws of [INSERT STATE]; that I have custody of the records of such [corporation]; and that as of the date of this certification, [INSERT DESIGNATED SIGNATORY NAME] holds the title of [INSERT TITLE] of the [corporation], and is authorized to execute and deliver in the name and on behalf of the [corporation] the Proposal submitted by the [corporation] in response to the Request for Proposals for Monterey Peninsula Water Supply Project Fitch Park ASR Wells 5 and 6 , issued by California-American Water Company on XXXX XX, 2018, as amended; and all documents, letters, certificates and other instruments which have been executed by such officer on behalf of the [corporation] in connection therewith.

IN WITNESS WHEREOF, I have hereunto set my hand and affixed the [corporate] seal of the [corporation] this \_\_\_\_\_ day of \_\_\_\_\_ 2018.

(Affix Seal Here)

\_\_\_\_\_  
Clerk/Secretary

*\* Note: Separate certifications shall be submitted if more than one corporate officer has executed documents as part of the Proposal. Proposers shall make appropriate conforming modifications to this Certificate in the event that the signatory's address is outside of the United States.*

**Monterey Peninsula Water Supply Project  
Request for Proposals  
Design Build of Fitch Park ASR Wells 5 and 6 Above Ground Facilities**

**Attachment 2**

**PROJECT TEAM MEMBER LIST**

Proposals shall identify the names and roles of the Proposer and any Significant Subcontractors and all other Project team members identified to date:

**NAME:**

**ROLE:**

---

---

---

---

---

---

---

---

---

---

---

Name of Proposer

---

Name of Designated Signatory

---

Signature

---

Title

**Monterey Peninsula Water Supply Project  
Request for Proposals  
Design Build of Fitch Park ASR Wells 5 and 6 Above Ground Facilities**

**Attachment 3**

**PROJECT TEAM LICENSE LIST**

Attach corresponding copies of applicable licenses

<b>License No.</b>	<b>Classification</b>	<b>Name of Licensee</b>	<b>Renewal Date</b>	<b>Active (Yes/No)</b>

**Monterey Peninsula Water Supply Project  
Request for Proposals  
Design Build of Fitch Park ASR Wells 5 and 6 Above Ground Facilities**

**PROPOSAL FORM 2**

**NON-COLLUSION AFFIDAVIT**

STATE OF \_\_\_\_\_ )  
                                                              : SS.:  
COUNTY OF \_\_\_\_\_ )

I, [INSERT DESIGNATED SIGNATORY NAME], a resident of [INSERT CITY], in the State of [INSERT STATE], of full age, being duly sworn according to law, on my oath depose and say that:

- 5.2.3.1.14.1.1.1. I am the [INSERT TITLE] of, [INSERT PROPOSER], formed in the state of [INSERT STATE], the Proposer making the Proposal in response to the Request for Proposals for the Monterey Peninsula Water Supply Project Fitch Park ASR Wells 5 and 6 issued by California-American Water Company on XXXX XX, 2018, as amended, and that I executed said Proposal with full authority to do so;
  
- 5.2.3.1.14.1.1.2. The prices in this Proposal have been arrived at independently without collusion, fraud, consultation, communication, or agreement, for the purpose of restricting competition, as to any matter relating to such prices with any other Proposer or with any competitor;
  
- 5.2.3.1.14.1.1.3. Unless otherwise required by law, the prices which have been quoted in this Proposal have not been knowingly disclosed by the Proposer and will not knowingly be disclosed by the Proposer prior to opening, directly or indirectly, to any other Proposer or to any competitor; and
  
- 5.2.3.1.14.1.1.4. No attempt has been made or will be made by the Proposer to induce any other person or entity to submit or not to submit a Proposal for the purpose of restricting competition.

I, hereby affirm under the penalties of perjury that the foregoing statements are true.

\_\_\_\_\_  
Name of Proposer

\_\_\_\_\_  
Name of Designated Signatory

\_\_\_\_\_  
Signature

**Monterey Peninsula Water Supply Project  
Request for Proposals  
Design Build of Fitch Park ASR Wells 5 and 6 Above Ground Facilities**

\_\_\_\_\_  
Title

(Use State-Appropriate Form for Notary Public)

State of \_\_\_\_\_

County of \_\_\_\_\_

On this \_\_\_\_\_ day of \_\_\_\_\_, 2018, before me appeared [DESIGNATED SIGNATORY], who is [INSERT TITLE] of [INSERT PROPOSER], a [INSERT STATE AND TYPE], personally known to me to be the person described in and who executed this Transmittal Letter and acknowledged that she/he signed the same freely and voluntarily for the uses and purposes therein described.

In witness thereof, I have hereunto set my hand and affixed my official seal the day and year last written above.

\_\_\_\_\_  
Notary Public in and for the State of \_\_\_\_\_

(Seal)

\_\_\_\_\_  
(Name Printed)

Residing at \_\_\_\_\_

Commission Number \_\_\_\_\_

**Monterey Peninsula Water Supply Project  
Request for Proposals  
Design Build of Fitch Park ASR Wells 5 and 6 Above Ground Facilities**

**PROPOSAL FORM 3**

**DISCLAIMER STATEMENT**

The information contained in or otherwise provided in connection with the Request for Proposals for the Monterey Peninsula Water Supply Project Fitch Park ASR Wells 5 and 6 Above Ground Facilities (the “RFP”) issued by California-American Water Company (“CAWC”) on XXXX XX, 2018, as amended, has been prepared by CAWC and, while such information is believed to be accurate and reliable, except as otherwise expressly set forth in the RFP, CAWC makes no representation as to such accuracy or reliability. In no way shall any such information constitute a representation or warranty by CAWC or any of its officials, employees, agents, consultants, attorneys, representatives, contractors, or subcontractors (the “CAWC Representatives”). The Proposer hereby releases and forever discharges CAWC and the CAWC Representatives from any and all claims which such Proposer has, had or may hereafter have arising out of any information contained in or otherwise provided in connection with the RFP. Any party who intends to submit a response to this RFP is specifically invited to independently verify the accuracy of the information contained herein.

---

Name of Proposer

---

Name of Designated Signatory

---

Signature

---

Title

**PROPOSAL FORM 4**

**KEY PERSONNEL<sup>1</sup>**

*(Copy and complete this form for Key Personnel. Attach additional pages along with organizational charts as needed)*

**General Information<sup>2</sup>**

Name: \_\_\_\_\_

Firm: \_\_\_\_\_

Title: \_\_\_\_\_

Year employed by firm: \_\_\_\_\_ years

Total Professional Experience: \_\_\_\_\_ years

Professional Registration and Licenses (type/number/state/year)<sup>3</sup> \_\_\_\_\_

**Project-Specific Information**

Title/Assignment \_\_\_\_\_

Description of Role/Responsibilities:

---

<b>Commitment<sup>4</sup></b>	<b>Permitting</b> _____ %	<b>Construction</b> _____ %	
	<b>Design/Engineering</b> _____ %	<b>Startup and Testing:</b> _____ %	

Footnotes:

- <sup>1</sup> Proposers shall duplicate this form for all Key Personnel. Refer to subsection 4.4.2 of the RFP for a list of the minimum personnel for which this form shall be completed.
- <sup>2</sup> Please indicate any staff that has changed from that provided in the Statement of Qualifications in accordance with subsection 4.4.2 of the RFP. Attach pages as necessary.
- <sup>3</sup> Where applicable, key construction personnel must provide either: (1) proof of current California licensure; or (2) if not currently licensed in California, a detailed plan to obtain a required California license no later than the effective date of the Contract.
- <sup>4</sup> Commitment indicates the amount of time (in percent) that the individual would be available to work on the Project during the construction, start-up and testing phases of the Project. Indicate by "N/A" where the individual is not proposed to be involved in a particular phase of the Project.

**PROPOSAL FORM 5**

**PRELIMINARY PROJECT SCHEDULE, SCHEDULED CONSTRUCTION DATE AND  
SCHEDULED ACCEPTANCE DATE**

The Proposer shall submit a preliminary Project schedule with the Proposal that includes important construction activities and milestones from issuance of the Notice to Proceed through final completion. This preliminary Project schedule shall be submitted in both written and electronic formats. The level of detail shall be in summary level for major procurement and construction activities. Major milestones throughout the construction period shall be included.

The preliminary Project schedule shall consist of, but not be limited to, the following:

- (i) Important procurement activities and milestones
- (ii) Important construction activities and milestones
- (iii) Important commissioning and testing milestones
- (iv) It shall indicate the sequence of Work and the time of starting and completing each part.

In addition, the Proposer shall summarize and provide a list of proposed major milestones and completion dates including, but not limited to:

- 5.2.3.2. Issuance of Notice to Proceed
- 5.2.3.3. Expected delivery of all materials and equipment
- 5.2.3.4. Date of construction commencement
- 5.2.3.5. Completion of major structures
- 5.2.3.6. Commissioning and functional testing commencement
- 5.2.3.7. Substantial Completion Date
- 5.2.3.8. Acceptance test
- 5.2.3.9. Date of acceptance
- 5.2.3.10. Date of Completion and readiness for final payment

The Proposer shall use the following format to provide this information:



**Monterey Peninsula Water Supply Project  
Request for Proposals  
Design Build of Fitch Park ASR Wells 5 and 6 Above Ground Facilities**

<b>TABLE 5-1 MAJOR ACTIVITIES AND MILESTONES<sup>1</sup></b>		
<b>ACTIVITY NUMBER</b>	<b>ACTIVITY/MILESTONE</b>	<b>DATE<sup>2</sup></b>

\_\_\_\_\_  
Name of Proposer

\_\_\_\_\_  
Name of Designated Signatory

\_\_\_\_\_  
Signature

\_\_\_\_\_  
Title

Footnotes:

<sup>1</sup> List each major activity and milestone separately.

<sup>2</sup> Indicate the end of activity or date milestone achieved.

**Monterey Peninsula Water Supply Project  
Request for Proposals  
Design Build of Fitch Park ASR Wells 5 and 6 Above Ground Facilities**

**PROPOSAL FORM 6  
ACCEPTANCE OF THE CONTRACT**

Proposer agrees to all of the provisions of the draft Contract except as expressly provided in the track changes or redline version of the draft Contract that is attached to this Proposal Form.

---

Name of Proposer

---

Name of Designated Signatory

---

Signature

---

Title

**PROPOSAL FORM 7**

**PRICE ESCALATOR INDICES**

**PRICE INCREASE USING CONSUMER PRICE INDEX:**

The unit price includes the costs of bonds, insurance, permits, sales tax, overhead, profit and all other costs.

**Consumer Price Index (CPI):** *Contract prices for Services will remain firm through (Enter Month, Day Year).*

*Design/Builder must request price adjustments, in writing, 30 days prior to the adjustment date of requested increase. If Design/Builder fails to request a CPI price adjustment 30 days prior to the adjustment date, the adjustment will be effective 30 days after CAWC receives and approves its written request.*

*Price adjustments will be made in accordance with the percentage change in the U.S. Department of Labor Consumer Price Index (CPI-U) for Urban Wage Earners and Clerical Workers (Current Series), West Region All Items.*

*The price adjustment rate will be determined by comparing the percentage difference between the CPI in effect for the base year six-month average (January through June OR July through December); and each (January through June OR July through December six-month average) thereafter. The percentage difference between those two CPI issues will be the price adjustment rate. No retroactive contract price adjustments will be allowed.*

<https://www.bls.gov/data/>

The following example indicates how to adjust contract pricing when using the CPI as a contract price adjustment clause: *(Remember, all price adjustments should be rounded to equal the pricing structure of the contract in question. For example, if the unit price is \$100, make sure that you round the CPI adjusted price to the same number of decimal places to ensure accuracy).*

**EXAMPLE**

First Contract Adjustment date: March 1, 2018  
Price to be adjusted: \$250  
Adjustment period: Annually

CPI Index in use: CPI-U All Urban Wage Earners and Clerical Workers (current Series), <https://www.bls.gov/data/> select "Top Picks" then select *West Region All Items.*

**First Adjustment Period:**

**Current index: 2018**

**250.416**

**Monterey Peninsula Water Supply Project  
Request for Proposals  
Design Build of Fitch Park ASR Wells 5 and 6 Above Ground Facilities**

<b>Base index:</b> 2017			242.384
<b>Subtract</b> the Base index from the Current index	250.416 - 242.384	=	8.032
<b>Divide</b> the result by the Base index	8.032 / 242.384	=	.0331
<b>Multiply</b> the result by 100 to obtain percentage	.0331 x 100	=	3.31%
<b>Multiply</b> the price to be adjusted by the % increase	\$250 x .0331	=	\$8.28
<b>Add</b> the price to be adjusted to the adjustment amount	\$250 + \$8.28	=	<b>\$258.28</b>

<b>CPI adjusted price</b> for contract term March 1, 2018	<b>\$258.28</b>
-----------------------------------------------------------	-----------------

It is important to note that with each price adjustment, the original CPI **Base** index date range must be compared to the most current CPI index date range. The adjustment will always be made to the original contract price. In other words, CAWC will not adjust a price that has been previously adjusted. Adjustments will only be made to the original agreed upon hourly price, e.g. Senior Engineer charges are \$250/Hour as set in the original agreement.

**PROPOSAL FORM 8**

**DIVERSE BUSINESS ENTERPRISES REQUIREMENT STATEMENT**

Owner utilizes the established guidelines from the California Public Utilities Commission (“CPUC”) to qualify diverse suppliers and requires certification as a Diverse Business Enterprise (“DBE”) by the Supplier Clearinghouse and/or the California Department of General Services. To be eligible for award of a contract from this solicitation, the bidder/proposer must execute and submit, as part of his or her bid/proposal, this statement. DBEs are divided into four classifications, as follows: Minority Business Enterprises (“MBE”), Women-Owned Business Enterprises (“WBE”), Disabled Veteran Business Enterprises (“DVBE”), and Lesbian, Gay, Bi-Sexual and Transgender Business Enterprises (“LGBTBE”). This statement shall be deemed a material factor in the Owner’s evaluation of the bid/proposal. Failure to complete and submit this statement, or the inclusion of a false statement, shall render the bid/proposal non-responsive.

The CPUC has set a goal for Owner to achieve at least 21.5% of total contract spend on DBEs, divided into the four classifications as follows: MBE – 15%, WBE – 5%, DVBE – 1.5%, and LGBTBE – goal to be established in 2020.

Owner has established certain minimum requirements, as set forth below, for the percentage of the total Contract Price that must be paid to DBEs (the “DBE Minimum”). The DBE Minimum for a contract will depend upon the total Contract Price for that contract, as set forth below. For example, for a contract with a Contract Price of \$1,200,000, the DBE Minimum is 25% and, therefore, at least \$300,000 must be paid to DBEs either as the primary contractor or as one or more subcontractors. Further, for a contract with a Contract Price of \$4,000,000, the DBE Minimum is 30% and, therefore, at least \$1,200,000 must be paid to DBEs either as the primary contractor or as one or more subcontractors.

<b><u>Total Contract Price</u></b>	<b><u>DBE Minimum</u></b>
\$100,000 - \$500,000	<b>15%</b>
\$500,001 - \$1,000,000	<b>20%</b>
\$1,000,001 - \$3,000,000	<b>25%</b>
\$3,000,001 and higher	<b>30%</b>

Notwithstanding the DBE Minimum set forth above, a bidder/proposer may propose, and is strongly encouraged to propose, a higher percentage of the Contract Price to be paid to DBEs. As part of its submission, the must respond to the questions below and identify the percentage of the Contract Price that will be paid to DBEs (such percentage must be NO LOWER THAN the DBE Minimum set forth above). The percentage of the Contract Price that will be paid to DBEs (to the bidder/proposer as primary contractor or to subcontractors), as indicated on this form, will be a contractual requirement (the “DBE Requirement”) that must be met by the bidder/proposer in performing the Contract Services. Failure to meet the DBE Requirement will be considered a breach of the contract and may result in termination of the contract by the Owner.

**Monterey Peninsula Water Supply Project  
Request for Proposals  
Design Build of Fitch Park ASR Wells 5 and 6 Above Ground Facilities**

Complete the items below:

1. Is bidder/proposer certified as a Diverse Business Enterprise with the CPUC Supplier Clearinghouse and/or the California Department of General Services?

Respond YES or NO: \_\_\_\_\_

If YES, provide a copy of your certification with your bid/proposal and identify which classification your firm is certified under (i.e., MBE, WBE, DVBE, or LGBTBE): \_\_\_\_\_

2. What is the DBE Requirement (the percentage of the Contract Price that will be paid to DBEs) that bidder/proposer will agree to in the contract for the Contract Services?

\_\_\_\_\_ % of Contract Price (such percentage must be equal to or greater than the DBE Minimum as set forth above)

Bidder/Proposer Name: \_\_\_\_\_

Printed Name of Authorized Person: \_\_\_\_\_

Signature of Authorized Person: \_\_\_\_\_

Title of Authorized Person: \_\_\_\_\_



CALIFORNIA  
AMERICAN WATER

**Design Build of Fitch Park ASR Wells 5 and 6  
Above Ground Facilities  
Design Build Construction Project  
Pacific Grove, CA**

**ATTACHMENT B**

**REQUEST FOR PROPOSAL  
SUBMITTAL DOCUMENTS**

**July 2018**

**CALIFORNIA-AMERICAN WATER  
511 FOREST LODGE ROAD, SUITE 100  
PACIFIC GROVE, CA 93950**

**California-American Water  
Pacific Grove  
Fitch Park ASR Wells 5 & 6 Above ground facilities**

**DESIGN/BUILD REQUEST FOR PROPOSAL**

<u>TABLE OF CONTENTS</u>	<u>PAGE #</u>
I. GENERAL PROPOSAL INSTRUCTIONS .....	GPI-1 to 10
PROPOSAL FORM .....	PF-1 to PF-7
II. INFORMATION TO BE SUBMITTED WITH THE PROPOSAL .....	ISP-1 to ISP-3
III. SCOPE OF DESIGN SERVICES	
A. Design Professional Services - Design Phase .....	SDS-1 to SDS-8
B. Design Professional Services - Construction & Operation Phase .....	SDS-9 to SDS-10
IV. Agreement .....	A-1 to A-9
A. Standard General Conditions of the Contract .....	0 to 28
C. Supplementary Conditions .....	SC-1 to SC-16
Appendix A – Limits of Liability Insurance and Sample Certificate of Insurance	
Appendix B – Release of Liens	
Appendix H – Design Memorandum Requirements	
C. American Water Works Service Company – Drawing Standards.....	0 to 16
V. ATTACHMENTS	
A. Fitch Park ASR Well 6 Above Ground Facilities, Design Concept	
– Background Information .....	1 to 7
B. Fitch Park ASR Well 5 Above Ground Facilities, Design Concept	
– Design Scope .....	11 to 20
Appendices:	
APPENDIX 1 PRELIMINARY DESIGN DRAWINGS	
APPENDIX 2 PROJECT TECHNICAL MEMORANDA	
APPENDIX 3 CALAM(CAWC) ELECTRICAL STANDARDS	
APPENDIX 4 PGE INFORMATION	
APPENDIX 5 MISCELLANEOUS INFORMATION	



## I. GENERAL PROPOSAL INSTRUCTIONS

### RFP-1 DEFINED TERMS

1.01 Terms used in this Request for Proposal have meanings assigned to them as defined in the Standard General Conditions of the Contract Between Owner and Design/Builder, EJCDC Document D-700 (2002 Edition). Certain additional terms used in this Request for Proposals have the meanings indicated below.

- A. Proposal Documents - The Advertisement or Invitation, Request for Proposal, Proposal Form, and the proposed Contract Documents (including all Addenda issued prior to acceptance of Proposals).
- B. Proposer - One who submits a Proposal directly to Owner.
- C. Successful Proposer - The Proposer to whom Owner (on the basis of Owner's evaluation as hereinafter provided) makes an award.
- D. Technical Exhibits - Documents prepared by Design/Builder that demonstrate the Proposer's plan for meeting the Owner's requirements as set forth in the Conceptual Documents.
- E. Target Cost – The Successful Proposer will provide a Target Cost for the Work with the Design Memorandum and upon completion of 60% design. Further definition of Target Cost is provided in the Supplementary Conditions definitions.

### RFP-2 COPIES OF PROPOSAL DOCUMENTS

#### 2.01 Obtaining and Use of Proposal Documents

- A. Complete sets of the Proposal Documents may be obtained from the Senior Buyer at the following mailing address: **Attention: Jay Drewry, California-American Water, 655 W. Broadway, Suite 1410, San Diego, CA 92101 email: jay.drewry@amwater.com**
- B. Complete sets of Proposal Documents must be used in preparing Proposals. Owner does not assume any responsibility for errors or misinterpretations resulting from the use of incomplete sets of Proposal Documents.
- C. Copies of Proposal Documents available on the above terms are only for the purpose of obtaining Proposals for the Work and do not confer a license or grant to Proposers for any other use.

#### 2.02 Identification of Conceptual Documents

- A. Conceptual Documents include Part III, Scope of Design Services and Part IV Attachments

### **RFP-3 QUALIFICATIONS OF PROPOSERS**

#### 3.01 Proposer's Qualifications

- A. Each Proposal must contain evidence of Proposer's qualification to do business in the state where the Project is located or covenant to obtain such qualification prior to award of the contract.

#### 3.02 Contractor

- A. Furnish the names, titles, their role in the project and qualifications of the key individuals that will be providing Construction Administration and Startup Services.

#### 3.03 Designation of Engineer

- A. The individual or entity that will be providing Design Professional Services shall be listed in the Proposal. If more than one entity will be responsible for providing the Design Professional Services list all of these in the Proposal. For each entity furnish the names, titles, their role in the Project and qualifications of the key individuals that will be providing Design Professional Services.

### **RFP-4 EXAMINATION OF CONTRACT DOCUMENTS AND SITE**

#### 4.01 Proposer's Responsibilities

- A. It is the responsibility of each Proposer before submitting a Proposal to:
  - 1. Examine and carefully study the Proposal Documents and other related data identified in the Proposal Documents;
  - 2. Visit the Site to become familiar with and satisfy Proposer as to the general, local and Site conditions that may affect cost, progress, performance or furnishing of the Work; See Division 1- General Requirements for limitations on the time and access to the site during construction.
  - 3. Become familiar with and satisfy Proposer as to all federal, state and local Laws and Regulations that may affect cost, progress, performance or furnishing of the Work;
  - 4. Study and carefully correlate Proposer's knowledge and observations with the Contract Documents and such other related data; and
  - 5. Promptly notify Owner of all conflicts, errors, ambiguities, or discrepancies that Proposer has discovered in the Proposal Documents.

#### 4.02 Reports of Subsurface Conditions

- A. The Supplementary Conditions identify those reports of explorations and tests of subsurface conditions, existing surface and subsurface structures, or

underground facilities at or contiguous to the Site in possession of Owner. Proposer may rely upon the general accuracy of the “technical data” contained in such reports but not upon other data, interpretations, opinions or information contained in such reports or otherwise relating to the subsurface conditions at the Site, nor upon the completeness thereof for the purposes of preparing Proposals, performing Design Professional Services, or Construction.

- B. Copies of any reports and drawings that may be referenced in paragraph 4.02.A will be made available by Owner to any Proposer on written request. Those reports and drawings are not part of the Contract Documents, but the “technical data” contained therein has been identified and established in Paragraph SC-4.02 of the Supplementary Conditions. Proposer is responsible for any interpretation or conclusion drawn from any “technical data” or any such data, interpretations, opinions or information.

#### 4.03 Site Conditions

- A. Before submitting a Proposal each Proposer will be responsible to obtain such additional or supplementary examinations, investigations, explorations, tests, studies and data concerning conditions (surface, subsurface and underground facilities) at or contiguous to the Site or otherwise, which may affect cost, progress, performance or furnishing of the Work or which relate to any aspect of the means, methods, techniques, sequences or procedures of construction to be employed by Proposer and safety precautions and programs incident thereto or which Proposer deems necessary to prepare its Proposal for performing and furnishing the Work in accordance with the time, price and other terms and conditions of the Contract Documents.

#### 4.04 Proposer’s Access to the Site

- A. On request, Owner will provide each Proposer access to the Site to conduct such examinations, investigations, explorations, tests and studies as each Proposer deems necessary for submission of a Proposal. Proposer must fill all holes and clean up and restore the Site to its former conditions upon completion of such explorations, investigations, tests and studies.

#### 4.05 Work at the Site by Others

- A. Reference is made to the Supplementary Conditions for the identification of the general nature of work that is to be performed at the Site by Owner or others (such as utilities) that relates to the Work for which a Proposal is to be submitted. On request, Owner will provide to each Proposer for examination access to or copies of Contract Documents (other than portions thereof related to price) for such work.

#### 4.06 Hazardous Environmental Condition

- A. The provisions of Paragraphs 4.01 through 4.05 above do not apply to Hazardous Environmental Conditions covered by Paragraph 4.04 of the General Conditions.

## **RFP-5 PRE-PROPOSAL CONFERENCE**

5.01 A Pre-Proposal Conference will be held at California American Water's Monterey Office, on **October 11, 2018, 9:00 AM Local Time**, at 511 Forest Lodge Road, Suite 100, Pacific Grove, CA 93950. Following the Pre-Proposal Conference, Proposers will have the opportunity to tour the site/plant, and representatives of Owner will be present to discuss the Project. **Proposers are encouraged to attend and participate in the conference.** Owner will transmit to all prospective Proposers of record such Addenda as Owner considers necessary in response to questions arising at the conference. Oral statements may not be relied upon and will not be binding or legally effective.

## **RFP-6 SITE AND OTHER AREAS**

6.01 The Site is identified in the Proposal Documents. All additional lands and access thereto required for temporary construction facilities, construction equipment or storage of materials and equipment to be incorporated in the Work are to be obtained and paid for by Design/Builder. Easements for permanent structures or permanent changes in existing facilities are to be obtained and paid for by Owner unless otherwise provided in the Proposal Documents.

## **RFP-7 INTERPRETATIONS AND ADDENDA**

7.01 All questions about the meaning or intent of the Proposal Documents are to be directed to California-American Water in writing. **Send questions to the attention of Jay Drewry at e-mail address [jay.drewry@amwater.com](mailto:jay.drewry@amwater.com); or via fax at 619-230-1096.** Interpretations or clarifications considered necessary by Owner in response to such questions will be issued by Addenda mailed or delivered to all parties recorded by Owner as having received the Proposal Documents. Questions received less than **seven (7)** days prior to the date for opening of Proposals may not be answered. Only questions answered by formal written Addenda will be binding. Oral and other interpretations or clarifications will be without legal effect.

7.02 Addenda may be issued to clarify, correct, or change the Proposal Documents as deemed advisable by Owner.

## **RFP-8 PROPOSAL SECURITY**

Not Required.

## **RFP-9 CONTRACT TIMES**

9.01 The OWNER desires to achieve substantial completion and readiness for final payment by **TBD and TBD**, respectively. The actual times for Substantial Completion and readiness for final payment shall be those times offered by the Proposer and entered into the Agreement upon award of the contract. These times will be taken into consideration by Owner during the evaluation of Proposals, and it will be necessary for the apparent Successful Proposer to satisfy Owner that they will be able to achieve Substantial Completion and be ready for final payment within the times specified or provide substantive reasoning why the times cannot be met.

## **RFP-10 LIQUIDATED DAMAGES**

10.01 Provisions for liquidated damages, if any, are set forth in the Agreement.

## **RFP-11 TECHNICAL EXHIBITS REQUIRED WITH PROPOSAL**

11.01 Proposers shall submit with their Proposals the following Technical Exhibits: See Part II, Information to be Submitted with the Proposal.

11.02 Unsuccessful Proposer shall retain an ownership and property interest in the Technical Exhibits. Owner may retain a record copy for information purposes; however, such documents are not intended or represented to be suitable for reuse by Owner or others on the Project or on any other project. Any reuse will be at Owner's sole risk and without liability or legal exposure to Proposer and Owner shall indemnify and hold harmless Proposer from all claims, damages, losses and expenses including attorneys' fees arising out of or resulting there from.

11.03 Technical Exhibits may include alternatives and/or deviations from the Conceptual Documents provided that such alternatives and/or deviations are called to the Owner's attention in separate written documentation to be submitted with the Proposal.

## **RFP-12 PREPARATION OF PROPOSAL**

12.01 The Proposal Form is included with the Proposal Documents. Additional copies may be obtained from Owner.

12.02 All blanks on the Proposal Form must be completed by printing in black ink or by typewriter and the Proposal signed. Insert the requested Fees in the Cost of the Work section. Insert the requested days in the Contract Times section. Insert the names of the exhibits attached to the Proposal in the Exhibit section.

12.03 Proposal Signatures

- A. A Proposal by a corporation must be executed in the corporate name by a corporate officer accompanied by evidence of authority to sign. The corporate seal must be affixed and attested by the secretary or an assistant secretary. The corporate address and state of incorporation must be shown below the signature.
- B. A Proposal by partnerships shall be executed in the partnership name and signed by a partner (whose title must appear under the signature), accompanied by evidence of authority to sign. The official address of the partnership shall be shown below the signature.
- C. A Proposal by Limited Liability Company shall be executed in the name of the firm by a member accompanied by evidence of authority to sign. The state of formation of the firm and the official address of the firm shall be shown below the signature.
- D. A Proposal by an individual shall show the Proposer's name and official address.

- E. A Proposal by a joint venture shall be executed by each joint venturer in the manner indicated on the Proposal Form. The official address of the joint venture shall be shown below the signatures.

12.04 All names must be typed or printed in black ink below the signature.

12.05 The Proposal shall contain an acknowledgement of receipt of all Addenda, the numbers of which must be filled in on the Proposal Form.

12.06 The address and telephone number for communications regarding the Proposal must be shown.

12.07 The Proposal shall contain evidence of Proposer's authority to do business in the state where the Project is located or covenant to obtain such qualification prior to award of the Contract. Proposer's state contractor license number for the state of the Project and professional engineering registration numbers must also be shown if required.

### **RFP-13 PROPOSAL PRICE**

13.01 Lump Sum

- A. Proposers shall submit a Proposal on a lump sum basis as set forth in the Proposal Form. Lump sum costs include design fees, Design/Builder's fee, construction superintendence, and bond costs. The cost of construction activities is not included in the RFP phase, however, in Section II Information to be Submitted with the Proposal, Proposer is asked to provide a construction cost estimate of the Work.
- B. The Proposal price shall include such amounts as the Proposer deems proper for overhead and profit on account of cash allowances, if any, named in the Contract Documents as provided in paragraph 10.02 of the General Conditions.

### **RFP-14 SUBMITTAL OF PROPOSALS**

14.01 Each prospective Proposer is furnished one copy of the Proposal Documents with one separate unbound copy of the Proposal Form and one electronic copy. The unbound copy of the Proposal Form is to be completed and submitted with the information requested in this RFP and as described in Part II, Information to be Submitted with the Proposal. **The portion of the Proposal covering the Cost of the Work, specifically section P-4, CONTRACT PRICE, shall be submitted with the remainder of the Proposal but in a separate, opaque, sealed envelope that clearly marked "COST PROPOSAL ENCLOSED"**. E-mailed and faxed copies of the Proposal Documents submitted to the Owner will not be considered. Proposal Documents submitted after the designated date and time shown below will not be considered.

14.02 One electronic (PDF format) copy of the proposal shall be submitted no later than **October 25, 2018, 3:00 PM (local time)**, to each of the following individuals:

*Jay Drewry  
California-American Water Company  
511 Forest Lodge Road, Suite 100  
Pacific Grove, CA 93950*

14.03 Proposals shall be enclosed in an opaque sealed envelope or box, marked with the Project title and name and address of Proposer and accompanied by other required documents. If the Proposal is sent through the mail or other delivery system the sealed envelope or box shall be enclosed in a separate envelope or box with the notation "PROPOSAL ENCLOSED" on the face of it. The electronic copy may be included as a CD with the paper copy, or it may be submitted via email to [jay.drewry@amwater.com](mailto:jay.drewry@amwater.com) if the total file size is less than 14 MB.

#### **RFP-15 MODIFICATION AND WITHDRAWAL OF PROPOSAL**

15.01 A Proposal may be modified or withdrawn by an appropriate document duly executed in the manner that a Proposal must be executed and delivered to the place where the Proposals are to be submitted prior to the date and time for the opening of the Proposals.

15.02 If within 24 hours after Proposals are opened any Proposer files a duly signed written notice with Owner and promptly thereafter demonstrates to the reasonable satisfaction of Owner that there was a material and substantial mistake in the preparation of its Proposal, that Proposer may withdraw its Proposal, and the Proposal security will be returned. Thereafter, if the Work is rebid, that Proposer will be disqualified from further consideration of being awarded the Contract.

#### **RFP-16 OPENING OF PROPOSALS**

Proposals will be opened privately.

#### **RFP-17 PROPOSALS TO REMAIN SUBJECT TO ACCEPTANCE**

17.01 All Proposals will remain subject to acceptance for the period of **75 days** from the receipt of the Proposal, but Owner may, in its sole discretion, release any Proposal and return the Proposal security prior to the end of that period.

#### **RFP-18 SELECTION CRITERIA**

18.01 In evaluating Proposals, Owner may consider:

- A. Whether the Proposals comply with the prescribed documents and other data as may be requested in the Proposal Form or prior to the Notice of Award.
- B. The Proposal prices as required in the Proposal Form.

- C. The innovative alternatives identified by the Proposers and opportunities the alternatives provide for reduction of capital costs and operating and maintenance costs. Innovative alternatives shall meet California-American Water standards.
- D. The qualifications of Proposers and the qualifications and experience of Subcontractors (including engineer), Suppliers, and other individuals and entities proposed for those portions of the Work as to which the identity of Subcontractors, Suppliers, and other individuals and entities must be submitted as provided in the Supplementary Conditions and as may be requested in the Proposal Form, Information to Be Submitted with the Proposal, Scope of Design Services, or prior to the Notice of Award.
- E. The extent to which the Technical Exhibits demonstrate the Proposer's plan for meeting of the Owner's requirements set forth in the Conceptual Documents and design solutions contained therein.
- F. The operating costs, maintenance requirements, performance data and guarantees of major items of materials and equipment proposed for incorporation in the Work when such data is required to be submitted prior to the Notice of Award.

18.02 The Proposals will be evaluated based upon five criteria as listed below. For the purpose of evaluating Proposals, these evaluation criteria will be given the following weights:

1)	Technical Submission	30%
2)	Commercial	25%
3)	Schedule & Work Plan	20%
4)	Qualifications and experience	15%
5)	Resources	10%

18.03 Owner may conduct such investigations as Owner deems necessary to assist in the evaluation of any Proposal and to establish the responsibility, qualifications and financial ability of Proposers and proposed engineers, Subcontractors, Suppliers, and other individuals and entities to perform and furnish the Work in accordance with the Contract Documents.

**RFP-19 REJECTION OF ALL PROPOSALS AND DISCREPANCIES; AWARD OF CONTRACT**

19.01 Rejection of All Proposals, Discrepancies

- A. Owner reserves the right to reject any or all Proposals, including without limitation nonconforming, non-responsive, unbalanced, or conditional Proposals. Owner further reserves the right to reject the Proposal of any Proposer whom it finds, after reasonable inquiry and evaluation, to be non-responsible. Owner may also reject the Proposal of any Proposer if Owner believes that it would not be in the best interest of the Project to make an award to that Proposer. Owner also reserves the right to waive all informalities not involving price, time or changes in the Work and to negotiate contract terms with the Successful Proposer.



- B. More than one Proposal for the same Work from an individual or entity under the same or different names will not be considered. Reasonable grounds for believing that any proposer has an interest in more than one Proposal for the Work may be cause for disqualification of that Proposer and the rejection of all Proposals in which that Proposer has an interest.
- C. If the Contract is awarded, Owner will award the Contract to the Proposer whose Proposal is in the best interests of the Project.

#### 19.02 Award of Contract

- A. If the contract is to be awarded, Owner will give Successful Proposer a Notice of Award within **75 days** after the day of the Proposal opening.

#### **RFP-20 CONTRACT SECURITY**

None Required

#### **RFP-21 SIGNING OF AGREEMENT**

21.01 When Owner gives a Notice of Award to the Successful Proposer, it will be accompanied by the required number of unsigned counterparts of the Agreement with the other Contract Documents that are identified in the Agreement as attached thereto. Within 15 days thereafter, Successful Proposer shall sign and deliver the required number of counterparts of the Agreement and attached documents to Owner. Within 15 days thereafter, Owner shall deliver one fully signed counterpart to Successful Proposer.

#### **RFP-22 PROPOSAL COMPENSATION**

None Provided.

#### **RFP-23 SALES AND USE TAXES**

23.01 Owner is not exempt from State local privilege (“sales”) and use taxes on installation labor, materials and equipment. Said taxes shall be included in the Proposal. Successful Proposer agrees to pay all applicable taxes, or work with Owner or Owner’s legal counsel in order to identify potential nontaxable labor, materials and equipment.

#### **RFP-24 RETAINAGE**

24.01 Provisions concerning retainage are set forth in the Agreement.

#### **RFP-25 PARTNERING**

25.01 Owner intends to participate in a partnering process with Design/Builder. The objectives of the process will be to achieve effective and efficient performance of the Work and completion of the Work within the Contract Price and Contract Times, all in accordance with the Contract Documents.

25.02 Participation in the partnering process will be recommended. See the Scope of Design Services for additional details.

25.03 The facilitator will be selected by Owner, subject to approval by Design/Builder. Owner will pay costs of the facilitator and facilities. Each party will pay all costs associated with the participation of its own personnel.

25.04 A primary objective of the partnering process is to maximize the potential for resolution of disputes in a timely and non-adversarial manner. The use of alternative dispute resolution (ADR) methods will be encouraged in order to promote and maintain amicable working relationships among the parties. In the event that ADR procedures are unsuccessful, the dispute resolution provisions set forth in the Contract Documents will be employed.

25.05 These provisions express the intent and spirit of the partnering process, and nothing stated herein or in the partnering statement shall change in any way the rights, responsibilities, and obligations of the parties as set forth in the Contract Documents. **The partnering statement will not be part of the Contract Documents and will not modify any defense, claim, obligation, or right that otherwise exists.**

**California-American Water  
Monterey Peninsula Water Supply Project  
Fitch Park ASR Wells 5 and 6 Above Ground  
Facilities  
Design Build Project  
Pacific Grove, CA**

**PROPOSAL FORM**

**P-1 PROJECT IDENTIFICATION:**

The project requires a Design Build Contractor (Contractor) to design, build, install complete, functional, and fully operational facilities for two Aquifer Storage and Recovery (ASR) well facilities in Seaside, California; a location map of the project sites is presented in Appendix A, Sheet T-1. The sites are currently undeveloped easement parcels along the eastern side of General Jim Moore Blvd., immediately west of Ardenes Circle.

A detailed description of each of the design elements is included in the Design Concept (Attachment A).

**P-2 THIS PROPOSAL IS TO BE SUBMITTED TO:**

CALIFORNIA AMERICAN WATER  
511 FOREST LODGE ROAD, SUITE 100  
PACIFIC GROVE, CA 93950  
Attn: Jay Drewry, Senior Buyer  
[jay.drewry@amwater.com](mailto:jay.drewry@amwater.com)

**P-3 PROPOSER'S OBLIGATIONS AND REPRESENTATIONS**

3.01 The undersigned Proposer proposes and agrees, if this Proposal is accepted, to enter into an Agreement with Owner in the form included in the Contract Documents to perform all Work as specified or indicated in the Contract Documents for the Contract Price and within the Contract Times indicated in this Proposal and in accordance with the other terms and conditions of the Contract Documents.

3.02 Proposer accepts all of the terms and conditions of the Proposal documents, including without limitation those dealing with the disposition of the Proposal security. This Proposal will remain subject to acceptance for 60 days after the day of Proposal opening. Proposer will sign and deliver the required number of counterparts of the Agreement with

any Bonds and other documents required by the Request for Proposal and Proposal Form within 15 days after the date of Owner's Notice to Proceed.

3.03 In submitting this Proposal Proposer represents and agrees, as more fully set forth in the Agreement, that:

A. Proposer has examined and carefully studied the Proposal Documents and the following Addenda (receipt of all which is hereby acknowledged)

Addendum No.	Addendum Date
_____	_____
_____	_____
_____	_____
_____	_____

B. Proposer has visited the Site and become familiar with the general, local and Site conditions that may affect cost, progress, performance and furnishing of the Work.

C. Proposer is familiar with all applicable federal, state and local Laws and Regulations that may affect cost, progress, performance and furnishing of the Work.

D. Proposer has carefully studied all available reports of explorations and tests of subsurface conditions at or contiguous to the Site and all available drawings of physical conditions relating to existing surface or subsurface structures at or contiguous to the Site which have been identified or made available by Owner.

E. Proposer is aware of the general nature of the work to be performed by Owner and others at the Site that relates to Work for which this Proposal is submitted as indicated in the Contract Documents.

F. Proposer has correlated the information known to Proposer, information and observations obtained from visits to the Site, reports and drawings identified in the Contract Documents and all additional examinations, investigations, explorations, tests, studies and data with the Contract Documents.

G. Proposer has given Owner written notice of all conflicts, errors, ambiguities or discrepancies that Proposer has discovered in the Contract Documents and the written resolution thereof by Owner is acceptable to Proposer, and the Contract Documents are generally sufficient to indicate and convey understanding of all terms and conditions for performing and furnishing the Work for which this Proposal is submitted.

H. This Proposal is genuine and not made in the interest of or on behalf of any undisclosed individual or entity and is not submitted in conformity with any agreement or rules of any group, association, organization or corporation; Proposer has not directly or indirectly induced or solicited any other Proposer to submit a false or sham Proposal; Proposer has not solicited or induced any individual or entity to refrain from submitting a

Proposal; and Proposer has not sought by collusion to obtain for itself any advantage over any other Proposer or over Owner.

P-4 CONTRACT PRICE

4.01 Proposer will complete the Work in accordance with the Contract Documents for the following price(s):

A. COST OF THE WORK

1. The Cost of all Work other than Unit Price Work shall be determined as provided in Paragraph 10.01 of the General Conditions, as revised or amended by the Supplementary Conditions and shall include the following amounts subject to increases or decreases for changes in Work as provided for in Article 8 of the Agreement

2. Lump Sum Fees

- a. Design Professional Services - Preliminary Design up to and Including Issuing of the Design Memorandum.

\$ \_\_\_\_\_

- b. Design Professional Services – Preliminary Design Completion through Final Design Phases.

\$ \_\_\_\_\_

- c. Design Professional Services – Construction/Operational Phase

\$ \_\_\_\_\_

- d. Pre-Construction Services during Design Phase

\$ \_\_\_\_\_

- e. Construction Supervision and Superintendence

\$ \_\_\_\_\_

- f. Cost of Bond Premiums (Based on construction estimate):

\$ \_\_\_\_\_

Premium unit Price \$ \_\_\_\_\_ / \$ \_\_\_\_\_

Range: \$ \_\_\_\_\_ to \$ \_\_\_\_\_

TOTAL LUMP SUM (a. + b. + c. + d. + e. + f.):

\$ \_\_\_\_\_

B. DESIGN/BUILDER's FEE

1. Lump Sum Fee \$ \_\_\_\_\_

P-5 CONTRACT TIMES

5.01 Proposer agrees that the Work will be substantially completed and ready for final payment in accordance with paragraphs 13.05 and 13.08 of the General Conditions on or before the dates or within the number of calendar days indicated in the Agreement.

Design Memo Completion: \_\_\_\_\_ days

(Insert days from Notice of Award to completion of the Design Memorandum)

Final Design Phase Completion: \_\_\_\_\_ days

(Insert days from Notice to Award to completion of the Final Design Phase)

5.02 Proposer accepts the provisions of the Agreement as to liquidated damages in the event of failure to complete the Work within the times specified in the Agreement.

P-6 EXHIBITS

6.01 The following documents are attached to and made a condition of this Proposal:

A. The individual or entity providing the Design Professional Services will be:  
(if more then one list all)

---

---

---

---

---

---

---

B. Listed below are the Exhibits the Design/Builder has attached to this proposal:

---

---

---

---

---

---

P-7 TERMINOLOGY

7.01 The terms used in this Proposal which are defined in the General Conditions of the Contract between Owner and Design/Builder (“General Conditions”) included as part of the Contract Documents have the meanings assigned to them in the General Conditions. Terms defined in the Request for Proposal are used with the same meaning in this Proposal.

P-8 SUBMISSION

SUBMITTED on \_\_\_\_\_.

State Contractor License No. \_\_\_\_\_.

State Certificate of Authority for Corporate Engineering Practice (If Applicable):

If Proposer is:

An Individual

By: \_\_\_\_\_ (SEAL)  
(Individual's Name)

doing business as \_\_\_\_\_  
Business address: \_\_\_\_\_  
\_\_\_\_\_

Phone No.: \_\_\_\_\_  
Facsimile No.: \_\_\_\_\_

A Partnership

By: \_\_\_\_\_ (SEAL)  
(Firm Name)

\_\_\_\_\_  
(general partner)

Business address: \_\_\_\_\_  
\_\_\_\_\_

Phone No.: \_\_\_\_\_  
Facsimile No.: \_\_\_\_\_



A Corporation

By: \_\_\_\_\_ (SEAL)  
(Corporation Name)

\_\_\_\_\_  
(state of incorporation)

By: \_\_\_\_\_ (SEAL)  
(name of person authorized to sign)

\_\_\_\_\_  
(Title)

\_\_\_\_\_  
(Corporate Seal)

Attest

\_\_\_\_\_  
(Secretary)

Business address: \_\_\_\_\_  
\_\_\_\_\_

Phone No.: \_\_\_\_\_

Facsimile No.: \_\_\_\_\_

Date of Qualification to do business as a foreign (out-of-state) corporation in state where  
Project is located (if applicable): \_\_\_\_\_

A Joint Venture

By: \_\_\_\_\_ (SEAL)  
(Name)

\_\_\_\_\_  
(Address)

By: \_\_\_\_\_ (SEAL)  
(Name)

\_\_\_\_\_  
(Address)

Business address: \_\_\_\_\_  
\_\_\_\_\_

Phone No.: \_\_\_\_\_

Facsimile No.: \_\_\_\_\_

(Each joint venturer must sign. The manner of signing for each individual, partnership and  
corporation that is a party to the joint venture should be in the manner indicated above.)

## II. INFORMATION TO BE SUBMITTED WITH THE PROPOSAL

The following minimum information must be submitted with Design/Builder's proposal for it to be accepted. Owner intends to award contract to the successful proposer.

1. Separate Lump Sum amounts for each of the following components in P-4 of the Proposal Form. **Lump Sum amounts listed below, specifically Section P-4, CONTRACT PRICE, of the Proposal Form, shall be submitted with the Proposal but in a separate, opaque, sealed envelope that is clearly marked "COST PROPOSAL ENCLOSED"**:
  - a. Design Professional Services for– Engineering through Preliminary Design Phase, up to and including issuance of the Design Memorandum. (See III. Scope of Design Services, Section A).
  - b. Design Professional Services for – Completion of Final Design Phases (See III. Scope of Design Services, Section A).
  - c. Design Professional Services - Construction/Operations Phase (See III. Scope of Design Services, Section B).
  - d. Pre-Construction Services during Design Phase - (See III. Scope of Design Services, Section B).
  - e. Supervision and Superintendence of Construction – See SC-10.01 Cost of the Work for a description of the costs to be included in this item.
  - f. Performance and Payment Bond premium based on the Design Builders estimated construction cost. Provide a premium unit price that can be used if construction cost differs from the estimated cost. Also, provide the range that unit price is valid.
  - g. Design Builders Fixed Fee
2. Provide the following Design/Build Team information relative to the proposed team qualifications:
  - a. Firms: Identify the companies in the design build team and any other companies you maybe teaming up, partnering or associating with during the project.
  - b. Design/Build/Partnering Experience: Identify the team's design/build and partnering experience, including experience on projects similar to the proposed. Include a brief description of the projects, their costs and the current names and telephone numbers of the owner or owner's contact.
  - c. Quality Management Plan Outline: Provide an organization chart showing reporting lines and responsibilities for the team. Provide references to company procedures to be used to manage the proposed project. Provide the method of management of the subcontractors. Provide the relationship of the contractor's safety plan to the above.

3. List areas of construction work which Design/Builder desires to perform with its own forces either through negotiation or successful competitive bidding against qualified subcontractors.
4. For self-performed work, provide all the classifications of labor to be employed and associated hourly unit cost inclusive of wages, fringe benefits, payroll taxes, insurance, etc.
5. Provide description of the services and facilities included in the lump sum cost of Supervision and Superintendent of Construction. Provide a Construction Phase organizational chart identifying Design/Builder Construction Supervision organization. Indicate those individuals who will be full or part-time on the project and where they will be located (i.e. on-site, office)
6. Provide a narrative description of the Design/Builder's understanding of the design concept for this facility. If the Design/Builder chooses to modify the proposed site layout included with the RFP, a drawing shall be provided to identify the proposed alternate layout. Additionally, provide specifics of any alternative design concepts, which may be proposed by the Design/Builder. The Design/Builder is encouraged to submit alternative design concepts, however, a proposal based on the defined design concept is mandatory. Should alternative proposals be submitted, preliminary sketches of the proposed facilities shall be included along with relative design and construction cost estimates comparing the alternative designs with that defined in this document.
7. Prepare a construction cost estimate of the Work, which shall be broken down by major work item, organized by Construction Specification Institute (CSI) division and major process components. This estimate will be used by the Owner to evaluate Design/Builder's understanding of the project, evaluate budget and rate impacts.
8. The anticipated number and depth of all soil borings, if any, required after award of contract.
9. Specifics of any exceptions, which are taken to items requested in this document. If no exceptions are taken, it is not necessary to reiterate the information in the Scope of Services Required.
10. A listing of drawings and specifications required for this project, with titles for each drawing.
11. A listing of all Federal, State, and local permits required for design, construction and operation of the proposed facility. Identify anticipated review time for each permit and any special requirement that may delay the process.
12. A project team organizational chart headed up by the proposed project manager and including all other engineering personnel from all disciplines who are expected to be directly associated with this project and construction supervision personnel.
13. Resumes and a work experience history of each individual identified in the project team organizational chart. Identify those individuals with Design Build Institute of America (DBIA) Designated Design-Build Professional™ Certifications. The resumes of those individuals to be associated with the instrumentation and controls design must

demonstrate their capabilities in those areas identified in the Scope of Services required for design.

14. Specific identification of any design sub-consultants that will be utilized for this project, exclusive of soil boring and survey work. If sub-consultants will be utilized, the resumes of the specific individuals will be required as well as a work experience history of their firms, including three (3) references with specific contacts and phone numbers.
15. A preliminary schedule for design, permitting, construction, testing, startup and commissioning of the project from date of award in Gantt chart form. If the time of completion desired by Owner is not acceptable, it shall be explicitly stated in the proposal. The schedule shall identify long lead time equipment and critical path to completion.
16. Identify a list of major and critical shutdowns anticipated to complete the project.
17. Concurrence that Design/Builder has read the Proposed Design/Builder Contract Documents included in the Attachments and are prepared to enter into this Agreement should Design/Builder's proposal be accepted by Owner.
18. Specific information describing how Design/Builder's firm plans to establish electronic communications with California-American Water Engineering if these capabilities are not already in place.
19. Evidence of Proposer's qualifications to do business in the State where the Project is located (See GPI-3.01).

### III. SCOPE OF DESIGN SERVICES

#### A. Design Professional Services- Preliminary and Final Design

Design Professional Services shall include the work described in General Conditions 6.01 as amended by the Supplementary Conditions and work described in this Scope of Design Services including all listed Attachments.

Review of the design will be performed by American Water engineering personnel. Any changes in the scope of services during the design phase must be addressed by the Design/Builder before the work is performed. Changes will be made in accordance with Articles 3 and 11 of the General Conditions.

1. Preparation of a brief critique of the design concepts to determine what modifications to the concepts may result in a more cost effective project, simplified construction, and/or improved operating procedures. This document shall be submitted prior to the initial design meeting.
2. Attendance at periodic meetings with the Owner at their site located in **Pacific Grove, CA**. At least ten (10) working days shall be allotted in the schedule for review of information by Owner prior to any meeting. It is expected several one-day meetings (unless otherwise noted) will be required during the design phase including:
  1. An initial conference (this will include review of the design critique and alternative concepts and be coupled with a one day partnering meeting mentioned below and in Supplementary Conditions SC-2.05 Initial Conference),
  2. Two meetings to review the instrumentation requirements (these will be coupled with the 30% and 60% design review meetings),
  3. Meetings to review the progressive completion at (15%, 30%, 60%, 90%, and 100%) of design drawings and specifications and to prepare for permit submittals. The draft Design Memorandum will be submitted for review prior to the 15% meeting. The final Design Memorandum and preliminary drawings will be reviewed at the 30% meeting.

The Design Builder is responsible for preparing notes summarizing the discussions and the conclusions from the meetings and distributing the notes within 7 days following the meeting.

The preliminary design phase will be considered complete at the 60% completion of design and upon Owner's approval of the construction cost estimate.

3. All land survey work as necessary to adequately complete the design and file permit applications and provide reference points for construction layouts. As a minimum, property lines, topographic information and location of existing structures are to be included.
4. All geotechnical investigations including soil borings, rock cores, and auger probing as necessary to adequately complete the design and estimate and plan construction earthwork.

5. All environmental activities as necessary to adequately complete the design and file permit applications.
6. Total interaction with all utility companies to design and specify proper service for the proposed improvements and to coordinate the relocation of existing utilities as required. The Design/Builder shall also determine if any additional capital or usage fees will be imposed by any specific utility.
7. Determine which Local, State, and Federal permits are required for the facility, prepare the necessary applications, and provide technical input as required in securing these permits. The Design/Builder shall also provide Owner with information regarding the approximate length of review time for each permit, and any special requirements that could delay this process (e.g., public hearings). When required by the permitting agency, the permit applications will be formally submitted by Owner.
8. Preparation of a preliminary budget construction cost estimate broken down by major work item, and a detailed construction cost estimate breakdown: (labor, materials, equipment, subcontract, temporary construction etc.) organized by Construction Specifications Institute (CSI) division and major process components. The preliminary estimate is to be submitted with the Design Memorandum. The detailed construction estimate is to be submitted in accordance with the Supplementary Conditions SC-6.01 Design Professional Services.
9. Preparation and maintenance of a Design Memorandum. The Design Memorandum is a summary of design data presented in outline format along with other pertinent project information. The primary intent of the memorandum is to allow Owner to review and comment on the design before the Design/Builder proceeds with detailed design and drafting. The memorandum shall be updated throughout the design and submitted to the Owner with each set of updated drawings. A summary of the information to be included in the memorandum is outlined in the Attachments. After completion of the draft Design Memorandum a meeting (15% completion) will be held with all parties. The purpose of the meeting will be to review the Design/Builder's Design Memorandum to determine and evaluate alternative concepts to reduce capital and operating costs and/or to improve operations. The Design Memorandum will be modified with the results of this evaluation by the Design/Builder.
10. Preparation of a narrative description of the operation of the proposed facilities to be used by plant operations personnel to familiarize themselves with the operation, capabilities, and limitations of the proposed improvements. The narrative shall be an extension of the process sections from the Design Memorandum, but in text format. It shall explain the intent and function of each unit process in addition to the system as a whole, and it shall include the detailed written control strategies (functional descriptions), which were prepared for the Design Memorandum submission. Preparation of the narrative shall not begin until the Design Memorandum is finalized and accepted. The narrative shall be submitted as a separate document for review at the final design review meeting. It shall serve as the foundation of the Operations and Maintenance Manual discussed in the Construction/Operation Phase section of this document.

11. Preparation of a complete and coordinated set of design drawings for all engineering disciplines with an adequate level of detail to allow for review/approval by permitting agencies and construction by the Design/Builder. Drawings used for permit applications and bidding require the signature and seal of a licensed professional engineer in the State of California. The drawing sets require segregation by major discipline: site, architectural, structural, mechanical, electrical, instrumentation, etc. Drawings shall not contain extensive notes and written instructions that are more appropriate for the specifications. Standard detail drawings shall exclude items that are not applicable to the current project.

The Design/Builder shall prepare all drawings using the most current version of AutoCAD for Windows. The Owner will not accept drawings created in an alternative CAD program, such as MicroStation, and "converted" to AutoCAD format. The Design/Builder shall use only AutoCAD and AutoLISP routines and no vendor-furnished or third party programs.

***PLEASE REFER TO AMERICAN WATER DRAWING STANDARDS AND SAMPLES.***

It is recommended that the Design/Builder submit an early review (e.g., 15 percent complete) set of .dwg files for this project. The Owner shall review the .dwg files for conformity with the Owner's AutoCAD standards and advise the Design/Builder of any necessary changes. The Owner then shall assume that the Design/Builder completes the remainder of the design in conformity with the Owner's AutoCAD standards. If it is later found that final documents do not conform, the Design/Builder shall revise the final .dwg files at the Design/Builder's cost. The Design/Builder shall have the opportunity to discuss the Owner's AutoCAD standards with Company staff.

Standards developed by the Owner, and applicable to this project, and selected drawings of the existing facilities are provided in the Attachments. The information provided in the record drawings may not represent actual field conditions. The Design/Builder has the responsibility to field verify and record the existing conditions as necessary to complete the design phase.

Electrical drafting symbols shall conform to IEEE Standard 315 and 315A. Specific requirements for the design of instrumentation and controls for water treatment processes or water distribution, where applicable, are:

- a. Conduct on-site investigations, interface with process engineers/designers, and review design materials and drawings to determine the type and location of primary sensors, control devices, panels and related instruments, and control equipment. The locations, elevations, and mounting details for these devices shall be included on the drawings.
- b. Prepare P&ID drawings in accordance with ISA Standard S5.1 and Remote Terminal Unit (RTU) Interconnection drawings (input/output point lists) from the P&IDs. Example RTU Interconnection drawing and an electronic template will be provided to the selected Design/Builder upon request. The RTU interconnection drawings must be sufficiently detailed and accurate such that they can be utilized by the System Integrators and provided back to the Owner as record drawings. The Design/Builder is responsible for allowing each of the pre qualified System

Integrators identified by the Owner to review the RTU Interconnection drawings prior to the final design review meeting. The minimum information to be included on the RTU Interconnection drawings is as follows:

- Wiring from field instruments to the appropriate I/O point on the RTU.
  - All signal isolation and signal conditioning equipment as required (e.g., a current to current isolator).
  - Connections associated with the communications between RTUs (radios, fiber optic modems, etc.).
  - Contacts and coils on digital outputs.
  - Wiring tags showing the RTU number, I/O type (AI, AO, DI, DO), RTU card number, and I/O point number.
  - Connections for DC power supplies.
- c. Prepare ladder logic diagrams to show the hard wired logic in panels and motor control logic in PLCs. Drawings shall be prepared to show the general configuration of all new panels, consoles, and the wiring between interconnected hardware components.
- d. Prepare conduit and wiring drawings showing conduit and signal wire routing using scaled base drawings of all facilities. Where appropriate, the conduit and wiring drawings shall be integrated into the electrical drawings.
12. Preparation of technical specifications, Divisions 2 through 16 in the CSI Spec-Text format, and the list of required shop drawings, in final electronic form for printing, copying, and binding by the Design/Builder. Specifications shall reflect only the scope of work for the current project. Standard specifications shall be modified to exclude items not applicable to the current project.

Specifications shall be prepared using the most current version of the Microsoft Word for Windows word processor. If your standard specifications are in a format other than Microsoft Word, they must first be converted to Microsoft Word format, thoroughly checked to ensure that a complete conversion was accomplished (including all tables, charts, headers, footers, etc.), then edited for this project as appropriate within Microsoft Word. The text shall be 11 point Arial font. An electronic file name for each specification section shall include a descriptive name preceding a 5-digit specification section number followed by the Microsoft Word file extension (e.g., PROJECT 11500.doc).

The American Water System Construction Contract Documents prohibit a Design/Builder from submitting substitute or "or equal" materials or equipment when a proprietary product, named manufacturer, or supplier has been specified. Provisions exist for bidders to submit alternatives to these items at bid time only. To ensure competitive pricing is being obtained for material and equipment that is not necessary to be a sole source item, it is recommended that at least three (3) acceptable manufacturers or products be listed in the specifications for each of these items. Specifying less than three (3) manufacturers is acceptable only when approved by the Owner in cases where the products of additional manufacturers are not deemed to be comparable or do not meet the project requirements. If design details have been used on the drawings that are based on one of the listed products,



this should be noted in the specifications. If design revisions are necessary to accommodate the other acceptable products, additional details shall be provided for the other products to facilitate complete and accurate bidding. Where an item is to be furnished on a sole source basis, only one (1) acceptable manufacturer or product will be listed in the specifications. If common items are included in multiple specification sections, language is to be included in the specifications that the same manufacturer is to be used for these common products.

In general one of the two specification methods above shall be used for all process, mechanical, and electrical equipment and other materials that are unique to the design (e.g., certain piping, valve, structural, mechanical, electrical and architectural products). Specifications for other materials or products that can be written prescriptively, by performance, or by reference to applicable standards, do not need to include specific manufacturers or products unless desired by the Design/Builder or the Owner.

The specific items and requirements of the specifications for the electrical control circuits and the instrumentation and controls for water processes or water distribution, where applicable, are listed below. The Design/Builder shall interface closely with the Owner in the development of these items.

- a. Specifications for the digital equipment, and field and panel mounted instruments. Communication protocol between control system equipment and other digital equipment shall be specified by the Design/Builder and verified that it is compatible with the DCS. Data to be transferred by serial communications with other digital equipment shall also be identified.
- b. An input/output point list.
- c. Instrument specification sheets that are in accordance with ISA Standard S20.
- d. Detailed written control logic and strategies (functional descriptions). Identification of the initial set points to be used at startup when variable set points are required in the control strategy shall also be identified.
- e. Graphic display descriptions. Each specific display shall be identified and a brief description provided. Each I/O point (or calculated value) that should appear on each display must also be identified (preferably by indicating the name or number of the display directly on the I/O list). Sample displays, which will be provided by the Owner, shall be included in the contract documents.
- f. Report definitions. All typical reports that the Owner will generate shall be integrated with the control system and be accessible via an electronic spreadsheet (Microsoft Excel) or electronic database (Microsoft Access). The Owner will provide examples of each specific report that shall be provided in the specifications. The I/O point or tag number that corresponds to each entry space in each report shall be identified directly on the example reports with appropriate instructions such as whether the data is an average, taken at a specific time of the day, etc. Entry spaces that the system cannot accommodate and need to be filled in manually shall be identified as such.

- g. Alarming strategies for all alarms conditions including both warning alarms and critical alarms. Warning alarms are defined as analog (or calculated) alarms that provide notification that a critical condition is being approached (e.g. high turbidity, low chlorine residual, etc.). Critical alarms initiate automatic action by the system to address a critical condition (e.g. shut down the facility, start a backup piece of equipment, etc.). The specific action associated with each critical alarm shall also be identified. The Design/Builder shall identify all initial alarm set points to be used at startup.
  - h. Structured Query Language (SQL) database definition. All analog values, integrated values, and other relevant historical data shall be identified by the Design/Builder for inclusion in the SQL database and trending by the Systems Integrator. The Integrator shall store all historical data in a Microsoft SQL Server format.
  - i. Narrative descriptions of all pump control circuits (pump starters for example). These descriptions shall describe in detail the operation of these circuits in the various operating modes (manual, auto, remote, etc.) and shall provide information relating to the purpose of each device (relays, timers, lights, etc.) included in the circuit.
13. Provide a total of ten (10) sets of design memoranda, drawings, and specifications to be used during the design period for review purposes prior to each meeting. This same distribution of final drawings and specifications along with all final design information shall be made at the completion of design. Where possible, this information shall be submitted in electronic format. The information shall include all design notes and calculations, the design memorandum, drawings, and specifications. Electronic information, submitted at the end of (or during) the project, shall be on electronic media acceptable to Owner. Provide one set of full-size plans at the completion of final design phase, along with an electronic PDF format set.
14. Performance of a constructability and Value Engineering review by the Design/Builder with participation of Owner. Review each element of construction work with consideration given to feasible methods of construction, constraints to construction (materials, labor, specialty construction, weather, plant operations, other, etc.), design details, time required to complete each element of work, and possible alternatives which would reduce costs.

## **B. Pre-Construction Services**

Pre-Construction Services shall include but not be limited to the following:

1. Make arrangements, schedule, chair and take minutes for all meetings during the design phase portion of the project.
2. Preparation and maintenance of a progress schedule throughout the duration of the design and construction phases is required. The schedule requirements are described in the General Conditions and Section 1300 of the Specifications. The initial schedule for this project must focus on completing work necessary to file the

necessary permit applications and procurement of necessary equipment and materials to meet the Contract Times.

3. Preparation and agreement of the Target Cost of Construction. The Target Cost is to be mutually agreed between the Owner and Design/Builder on an open book basis (with costs established upon the principles of Cost of Work under paragraphs 10.01 to 10.03 of the General Conditions) during the course of the design development. Upon reaching stated percentage completion of the design, including reconciliation of Owner's comments, the Design/Builder shall prepare and present the Target Cost for Owner's agreement.

Target Cost Development:

General: As a minimum, the Target Cost shall be prepared and presented in general conformance with the Sixteen (16) Division Format of the Construction Specifications Institute (CSI) and/or by Area of Work as defined in the Estimated Cost of Construction template form; the final content and format is to be agreed with the Owner. Full description of the Target Cost arrangement is provided in the Supplementary Conditions and the Agreement.

A minimum of three (3) quotations or proposal from Owner-approved suppliers, vendors, manufacturers, subcontractors, etc. shall be obtained to set the target cost for all equipment, materials, products, and subcontracted labor and services. Receiving less than three (3) quotations or proposals is acceptable when approved by the Owner or in cases where the products or services of additional or other suppliers, vendors, manufacturers, subcontractors, etc. are not deemed to be comparable or do not meet the project requirements. The lowest responsive quotation or proposal shall be used to set the cost unless approved by the Owner. The cost for self performed work shall be agreed upon pursuant to SC 10.01. An amount for the Design/Builder's risk/contingency may be included as set forth in the Agreement.

The Design/Builder shall submit the Target Cost to Owner and include a cover letter detailing the basis of the Target Cost, CSI and/or Work Area estimates and all supporting documentation that shall be clearly listed, labeled and itemized.

Target Cost shall be developed as follows:

- A. Preliminary Target Cost shall be developed at the 30% design completion stage. Quotations and proposals shall be based on and reference the 30% design documents and shall be specific to model, size, material, etc. as applicable. "Budgetary" quotations or proposals may be used to develop costs if the design of that item or discipline has not progressed to the point where more specific quotations or proposal can be furnished.
- B. The Target Cost shall be developed upon completion of the 60% design, including incorporation of Owner's comments. Quotations and proposals shall be based on and reference the 60% design documents and shall be specific to model, size, material, etc. as applicable. The quotations and proposals shall be accurate, complete and remain valid for a minimum of 60 days and be ready for execution by the Design/Builder. "Budgetary" quotations or

proposals may not be used to develop the Target Cost unless approved by the Owner. In such instances, the budgetary quotation may be used as a “place-holder” to assist in setting the Target Cost at the discretion of the Owner and will be subject to revision once appropriate quotations or proposal can be obtained.

4. Preparation of a detailed construction sequence and logistics plan describing how the proposed facilities will be constructed and placed in-service while keeping existing facilities in-service as necessary. The plan shall consider seasonal limitations and shall specifically define all partial or full outages (including electrical) with estimated time for each outage as well as details on proposed time of day (i.e. regular working hours or evening/weekend hours), proposed time of year (i.e. during peak or off-peak demand seasons) and any special precautions, actions, temporary facilities, etc, that shall be required to safely complete each outage. The plan must be reviewed and approved by Owner to ensure that operations of any existing facilities will be properly maintained during construction. The plans are to show, at a minimum, the scheduled completion of construction on a calendar quarterly basis. Cost associated with keeping the plant on-line as a result of this plan shall be included in the Cost of Construction. As a consequence, the detailed construction sequence and logistics plan must be completed as part of the 60% design.
5. Provide constructability reviews at the 15%, 30%, 60%, and 90% of the design development phase. Review each element of construction work with consideration given to feasible methods of construction, constraints to construction (materials, labor, specialty construction, weather, plant operations, etc.) design details, time required to complete each element of work, and possible alternatives which would reduce costs, and maintain the level of quality expected by the Owner.

The reviews shall include the appropriate designers, the Owner, and subcontractors if required as participants.

Include providing the net cost and or time savings associated with each suggested change or modification to the design. Maintain a log tracking each suggestion with the results pertaining to cost and or time savings and acceptance/partial acceptance/rejection.

6. Performance of a bidability review with participation of Owner. Review the breakdown of the work into bid packages that will yield the most cost effective construction program with consideration given to the availability of qualified subcontractors and vendors. Develop interest in the project from prequalified subcontractors and vendors.
7. Maintain electronic communication capabilities throughout the design and construction phases of the project.

The Web browser that you utilize must be capable of handling file attachments, and your e-mail must be MIME (Multipurpose Internet Mail Extensions) compatible in order to send file attachments without the need to encode/decode. Additionally, all electronic data files (word processing documents, spreadsheets, etc.) created by American Water will be prepared using the **2010 version of Microsoft Office**, and the Consultant must have the ability to read these file formats. It is preferred, but not

mandatory, that the consultant also create all data files that may need to be shared via the Web or e-mail in Microsoft Office format.

8. Identify the permits that are required for construction phase of the project, and prepare the necessary applications, and secure these permits. Provide the Owner with information regarding the approximate length of review time for each permit, and any special requirements that could delay this process. Provide all information required for the permit application and submit the fees required. The Owner will reimburse the Design/Builder for all permit application and permit fees at their direct cost. Include but not limited to the Building Permit, electrical, etc. including wastewater discharge if required.

### **C. Design Professional Services – Construction/Operation Phase**

Design Professional Services-Construction/Operation Phase must include the following services:

1. Attendance at construction progress meetings, resolution of construction problems related to the design, and review and interpretation of the design.
2. Shop drawing review and approvals including review and approval of resubmittals, and maintenance of a shop drawing log indicating dates received, returned, and status.
3. Preparation of supplementary detailed working drawings, specifications, and written instructions or meetings as necessary throughout the construction period to interpret the contract plans and documents and to resolve changes brought about by actual field conditions encountered.
4. Provide the services of the I&C Staff Engineer or Subconsultant to witness the factory acceptance test (FAT) of the assembled I&C system prior to the system's shipment from the factory to the job site. The first goal is to ensure that the system has been assembled properly and is in proper working order. This will include testing of each individual I/O point and should be witnessed by the I&C Staff Engineer. The second goal is to simulate and test the control logic, and this portion of the FAT should be attended by the Design Project Manager/Engineer or someone familiar with the details of the process design and operation of the facility. Additionally, provide the services of the I&C Staff Engineer for site visits to review and inspect the instrumentation and wiring of field mounted instruments, resolution of problems, initial calibration and testing, and system start-up.
5. Provide the services of the Design Project Manager/Engineer who will participate in and observe each process and/or phase of initial operation of the project (start-up) and review operation and performance tests required by the contract specifications. At least five (5) days should be allotted for on-site start-up services and resolution of initial operating problems. Engineers from all of the engineering disciplines shall be made available to resolve start-up issues as required, and also to resolve problems which may arise during the construction period allow ten (10) site visits for these services.

6. Preparation and submittal of electronic record drawings within two (2) months after start-up. The record .dwg files shall conform to the Company's AutoCAD standards. If it is found that final documents do not conform to the Company's AutoCAD standards, the Consultant shall revise the final .dwg files at the Consultant's cost. Data, information, sketches and working drawings, to be incorporated with the record drawings, shall be provided by the Design/Builder. The record drawings shall include all above and below grade changes from the original design drawings for all engineering disciplines. Changes made to reflect the as-installed conditions shall be made in the same level of detail and to the same degree of drafting quality as the original design drawings. The I&C engineer must review record drawings prepared by the wiring contractors to verify their accuracy prior to substantial completion. Reference Division 1 of the specifications for additional information.
7. Provide four (4) copies of an operation and maintenance manual containing operating, maintenance, and repair information from manufacturer's submittals. The O&M manual shall also contain the final narrative description of the operation of the proposed facility, and a complete description of start-up and shut-down procedures. The O&M manual shall be bound in 3-ring binders and indexed with tabs according to major process designations in the order of the treatment process. Four (4) complete electronic copies of the final O&M manual shall also be provided on CD. An initial draft of the O&M manual, without manufacturer's data, shall be submitted for review at approximately the 50% point of construction completion. The complete O&M manual containing all manufacturer's data shall be submitted at the 95% point of construction completion but no later than one (1) month before scheduled start-up.
8. Provide the services of the Design Project Manager/Engineer for a one (1) day inspection of the facilities approximately twelve (12) months after they are placed into operation. The Design Project Manager/Engineer shall provide a written report summarizing warranty repairs that are necessary, as well as any operational modifications that are recommended to optimize performance.

# AGREEMENT

THIS AGREEMENT is by and between **California-American Water Company** (Owner) and \_\_\_\_\_ (Design/Builder). Owner and Design/Builder, in consideration of the mutual covenants hereinafter set forth, agree as follows:

## ARTICLE 1 – THE WORK

1.01 Design/Builder shall complete all Work as specified or indicated in the Contract Documents. The Work is generally described as follows:

Design, construct, renovate, start-up, commission, turn over and warrant facilities for **Owner’s Fitch Park ASR Wells 5 and 6 Above Ground Facilities**

## ARTICLE 2 - THE PROJECT

2.01. The Project for which the Work under the Contract Documents may be the whole or only a part is generally described as follows:

**Fitch Park ASR Wells 5 and 6**

## ARTICLE 3 - CONTRACT TIMES

3.01. Dates for Substantial Completion and Final Payment

The Work will be substantially completed in accordance with paragraph 13.05 of the General Conditions on or before \_\_\_\_\_ and completed and ready for final payment in accordance with paragraph 13.08 of the General Conditions on or before \_\_\_\_\_. In addition the following interim milestones will be met:

Design Memo Completion: \_\_\_\_\_ days – Defined as number of days from Notice of Award to completion of the Design Memorandum.

Design Phase Completion: \_\_\_\_\_ days – Defined as number of days from Notice of Award to completion of the Final Design.

3.02. Liquidated Damages

Design/Builder and Owner recognize that time is of the essence of this Agreement and that Owner will suffer financial loss if the Work is not completed within the times specified in paragraph 3.01 above, plus any extensions thereof allowed in accordance with paragraph 11.02 of the General Conditions. The parties also recognize the

delays, expenses, and difficulties involved in proving the actual loss suffered by Owner if the Work is not completed on time. Accordingly, instead of requiring any such proof, Owner and Design/Builder agree that as liquidated damages for delay (but not as a penalty) Design/Builder shall pay Owner **\$2,000** for each day that expires after the time specified in paragraph 3.01 for Substantial Completion until the Work is substantially complete. After Substantial Completion, if Design/Builder shall neglect, refuse, or fail to complete the remaining Work within the time specified in paragraph 3.01 for completion and readiness for final payment or any proper extension thereof granted by Owner, Design/Builder shall pay Owner **\$500** for each day that expires after the time specified in paragraph 3.01 for completion and readiness for final payment.

#### ARTICLE 4 - CONTRACT PRICE

4.01 Owner shall pay Design/Builder for completion of the Work in accordance with the Contract Documents a sum equal to the Cost of the Work plus a Design/Builder's Fee for overhead and profit, both of which will be determined as provided in Article 5 and Article 6 of this agreement.

#### ARTICLE 5 - COST OF THE WORK

5.01 Cost of the Work shall be determined as provided in paragraph 10.01 of the General Conditions, as revised or amended by the Supplementary Conditions and shall include the following agreed to amounts which shall be subject to increases or decreases for changes in the Work as provided in Article 8 hereof:

- A. Lump Sum: \$\_\_\_\_\_ for Design Professional Services - Preliminary Design up to and including issuing of the Design Memorandum.
- B. Lump Sum: \$\_\_\_\_\_ for Design Professional Services – Completion of Final Design Phases.
- C. Lump Sum: \$\_\_\_\_\_ for Design Professional Services – Construction/Operational Phase.
- D. Lump Sum: \$ \_\_\_\_\_ for Pre-Construction Services during Design Phase.
- E. Lump Sum: \$\_\_\_\_\_ for Construction Supervision and Superintendence as described in the Supplementary Conditions.
- F. A Lump Sum of: \$\_\_\_\_\_ for the premium for the required bonds (based on \$\_\_\_\_\_ construction cost estimate).

5.02. At final completion should the Cost of the Work, as audited and approved by the Owner exceed the Target Cost, the Design/Builder shall be entitled to a 50% payment for the difference between the Final Cost of the Work and the Target Cost as provided.



- 5.03 At final completion should the Cost of the Work as audited and approved by the Owner be less than the Target Cost, an additional payment shall be made to the Design/Builder equal to 50% of the difference between final Cost of the Work and Target Cost as an incentive to the Design/Builder to reduce the project cost to Owner.
- 5.04. It is understood that the Contract Price has been calculated on the basis of Conceptual Documents and that further development will occur as necessary to produce Final Contract Drawings and Specifications necessary to complete the design, to obtain regulatory approvals and to perform the Work. No adjustment will be made to the Contract Price unless future development of these Conceptual Documents during the Preliminary Design Phase results in material changes in the scope, extent or character of the work to be performed or furnished or in the quality or function of the intended completed project not reasonably inferable or anticipatable from the Conceptual Documents by a Design/Builder experienced in the construction of water treatment facilities.

#### ARTICLE 6 - DESIGN/BUILDER'S FEE

6.01. The Design/Builder's fee shall be determined as follows:

- A. A fixed fee of \_\_\_\_\_ dollars (\$\_\_\_\_\_) which shall be subject to increases or decreases for changes in the Work as provided in paragraph 8.01.A below.

#### ARTICLE 7 - GUARANTEED MAXIMUM PRICE

7.01. Not Used.

#### ARTICLE 8 - CHANGES IN THE CONTRACT PRICE

8.01. The amount of any increases or decreases in the Design/Builder's Fee which results from a change in the work shall be set forth in the applicable document amending the Contract Documents subject to the following:

- A. Design Phase Changes: For changes in the Work ordered by Owner prior to completion of the Design Phase, the fixed fee will be adjusted by 5% of the estimated construction cost increase or decrease associated with the change. For changes involving cost increases, if during the Design Phase, Owner and Design/Builder are unable to agree to, or establish, the estimated construction cost increase associated with the change, this determination will be deferred to the Construction Phase at which time the actual Cost of the Work associated with the change is to be determined and used to make the 5% fixed fee adjustment.
- B. Construction Phase Changes: After completion of the Preliminary (60%) Design Phase, and approval of the final construction cost estimate, no adjustments to the fixed fee shall be made unless Owner orders additions or deletions to the Work which directly result in the Cost of the Work being greater than 110%, or less than 90% of the final construction cost estimate. In such case the fixed fee shall be increased by 10%

of the actual cost directly attributable to the change above 110% of the estimate or decreased by 5% of the cost directly attributable to the change below 90% of the approved estimate. Documents amending the Contract Documents as applicable will be issued to document Owner additions or deletions to work.

- 8.02. The amount of any increase or decrease in the Lump Sum Amounts provided in Article 5 hereof in shall include only direct costs (i.e. no fee) and shall be determined in accordance with paragraph 11.01 B of the General Conditions as may be revised or amended by the Supplementary Conditions.

## ARTICLE 9 - PAYMENT PROCEDURES

- 9.01. Design/Builder shall submit and Owner will process Applications for Payment in accordance with Article 13 of the General Conditions. Applications for Payment will indicate the amount of the Design/Builder's Fee then payable.

- A. Progress Payments; Retainage. Owner shall make progress payments on account of the Contract Price on the basis of Design/Builder's Applications for Payment on or about the 25<sup>th</sup> day of each month during performance of the Work as provided in paragraphs 9.01.A.1 and A.2 below. All such payments will be measured by the acceptable Schedule of Values established in paragraph 2.06 of the General Conditions (and in the case of Unit Price Work based on the number of units completed).

1. For Cost of the Work: Progress payments on account of the Cost of the Work will be made:
  - a. Prior to Substantial Completion, in an amount equal to the percentage indicated below, but in each case, less the aggregate of payments previously made and less such amounts as Owner may withhold in accordance with paragraph 13.03.B of the General Conditions.
    - (1) Unless otherwise agreed to in advance by Owner for specific subcontracts or material/equipment purchase orders, 100% of Cost of the Work completed (with the balance being retainage) with the exception of the lump sum amounts identified in paragraph 5.01 hereof.
    - (2) Unless otherwise agreed to in advance by Owner for specific subcontracts or material/equipment purchase orders, 95% of the cost of materials and equipment not incorporated in the Work (but delivered, suitably stored and accompanied by documentation satisfactory to Owner as provided in paragraph 13.02.A of the General Conditions).
    - (3) 100% (no retainage) of the Work completed relative to the lump sum items to be included in the Cost of the Work identified in paragraph 5.01 hereof.

- b. Upon Substantial Completion and receipt of Release of Liens from suppliers and subcontractors whose Work is completed on the Project, in an amount to increase the total payments to the Design/Builder such that retained funds will be approximately equal to the value of the remaining Work. Value to be agreed upon by Owner and Design/Builder, less such amounts as Owner shall determine that Owner may withhold, in accordance with paragraph 13.04.B of the General Conditions.
2. For Design/Builder's Fee: Progress payments on account of the Design/Builder's Fee will be made:
  - a. If the Design/Builder's Fee is a fixed fee: payments will be in an amount equal to 100% of such fee earned to the date of the approved Application for Payment (less in each case payments previously made on account of such fee) based on the progress of the Work measured by the Schedule of Values established as provided in paragraph 2.06.A of the General Conditions.
- b. Final Payment. Upon final completion and acceptance of the Work in accordance with paragraph 13.09 of the General Conditions, Owner shall pay the remainder of the Contract Price.

#### **ARTICLE 10 – Diverse Business Enterprise Requirement**

- A. Owner utilizes the established guidelines from the California Public Utilities Commission (“CPUC”) to qualify diverse suppliers and requires certification as a Diverse Business Enterprise (“DBE”) by the Supplier Clearinghouse and/or the California Department of General Services. Generally, a DBE is a business in which 51% or more of the ownership interest is held, and 51% or more of the daily management and control of the business is performed, by one or more certified diverse suppliers. DBEs are divided into four classifications, as follows: Minority Business Enterprises (“MBE”), Women-Owned Business Enterprises (“WBE”), Disabled Veteran Business Enterprises (“DVBE”), and Lesbian, Gay, Bi-Sexual and Transgender Business Enterprises (“LGBTBE”).
- B. Consultant represents and warrants that the percentage of the Contract Price that will be paid to DBEs, including to the Consultant and any of Consultant’s subcontractors, will be at least **25%** (the “DBE Requirement”). If Consultant fails to meet the DBE Requirement, such failure will be deemed a Default and may result in termination of this Agreement by Owner pursuant to Section 15.02 of the General Conditions.
- C. The CPUC requires Owner to report the amount of Owner’s DBE spend in compliance with General Order 156. In order for Owner to meet this requirement, Consultant is required to submit a quarterly report to Owner, in a form provided by or acceptable to Owner, identifying (1) the total dollar amount of Contract Price paid by Owner to Consultant as of date of report (“Amount Paid to Date”), (2) the percentage of Amount Paid to Date that has been paid to DBEs, whether to Consultant or any of Consultant’s subcontractors (“DBE Percentage”), and (3) the breakdown of the DBE Percentage into a percentage for each of the four classifications of DBEs (i.e., MBE, WBE, DVBE, and LGBTBE). Consultant will participate and assist, as requested by Owner, in any audit activities relating to this program. In addition, Consultant will

produce copies of invoices and cancelled checks to DBE subcontractors if requested by Owner.

## ARTICLE 11 - DESIGN/BUILDER'S REPRESENTATIONS

11.01. To induce Owner to enter into this Agreement, Design/Builder makes the following representations:

- A. Design/Builder has examined and carefully studied the Contract Documents (including the Addenda) listed in paragraphs 13.01.A through J and the other related data identified in the Request for Proposals but excluding the documents described in paragraph 13.01.K.
- B. Design/Builder has visited the Site and become familiar with and is satisfied as to the general, local, and Site conditions that may affect cost, progress, and performance of the Work.
- C. Design/Builder is familiar with and is satisfied as to all federal, state, and local Laws and Regulations that may affect cost, progress, and performance of the Work.
- D. Design/Builder has carefully studied all: (1) reports of explorations and tests of subsurface conditions (if any) at or contiguous to the Site and all drawings of physical conditions in or relating to existing surface or subsurface structures at or contiguous to the Site which have been identified or made available by Owner and (2) reports and drawings of Hazardous Environmental Conditions, if any, at the Site which have been identified or made available by Owner.
- E. Design/Builder is aware of the general nature of work to be performed by Owner and others at the Site that relates to the Work as indicated in the Contract Documents.
- F. Design/Builder has correlated the information known to Design/Builder, information and observations obtained from visits to the Site, reports and drawings identified in the Contract Documents, and all additional examinations, investigations, explorations, tests, studies and data with the Contract Documents.
- G. Design/Builder has given Owner written notice of all conflicts, errors, ambiguities, or discrepancies that Design/Builder has discovered in the Contract Documents and the written resolution thereof by Owner is acceptable to Design/Builder.
- H. The Contract Documents are generally sufficient to indicate and convey understanding of all terms and conditions for performance and furnishing of the Work.

## ARTICLE 12 - ACCOUNTING RECORDS

12.01. Design/Builder shall keep such full and detailed accounts of all materials, equipment, and labor entering into the Work as may be necessary for proper financial management under this Agreement, and the accounting methods shall be satisfactory to Owner. Owner shall be afforded access to all Design/Builder's records, books, correspondence, instructions, drawings, receipts, vouchers, memoranda, and other similar data relating to the Cost of the Work and Design/Builder's fee. Design/Builder

shall preserve all such documents for a period of three years after final payment by Owner.

## ARTICLE 13 - CONTRACT DOCUMENTS

13.01. The Contract Documents consist of the following:

- A. This Agreement (pages A-1 to **A-11**, inclusive);
- B. Performance Bond (pages \_\_\_\_\_ to \_\_\_\_\_, inclusive);
- C. Payment Bond (pages \_\_\_\_\_ to \_\_\_\_\_, inclusive);
- D. Other Bonds, identified as Exhibits \_\_\_\_\_ and consisting of \_\_\_\_\_ pages;
- E. Standard General Conditions of the Contract Between Owner and Design/Builder (pages 1 to **28**, inclusive);
- F. Supplementary Conditions (pages **SC-1** to **SC-16**, inclusive);
- G. Conceptual Documents identified in the Request for Proposals;
- H. Design/Builder's Proposal;
- I. Addenda numbers \_\_\_\_\_ through \_\_\_\_\_ inclusive;
- J. Exhibits to this Agreement (pages \_\_\_\_\_ to \_\_\_\_\_, inclusive), including Exhibit A – *DBE Good Faith Efforts Requirements*, Exhibit B - *Davis Bacon Contract Provisions*, and Exhibit C - *Local Resources Utilization Plan*;
- K. Documentation submitted prior to the effective date of the Agreement;
- L. The following, which may be delivered, prepared, or issued after the Effective Date of this Agreement and are not attached hereto:
  - 1. Notice to Proceed;
  - 2. All Work Change Directives, and Change Orders amending, modifying or supplementing the Contract Documents pursuant to paragraph 3.04.A of the General Conditions;
  - 3. Specifications as defined in Paragraph 1.01.A.40 of the General Conditions; and
  - 4. Drawings as defined in Paragraph 1.01.A.18 of the General Conditions.

13.02. The documents listed in paragraph 13.01 above are attached to this Agreement (except as expressly noted otherwise above).

13.03. There are no Contract Documents other than those listed above in this Article 13.

- 13.04. The Contract Documents may only be amended, modified, or supplemented as provided in paragraph 3.03.A of the General Conditions.

#### ARTICLE 14 - MISCELLANEOUS

- 14.01. The Standard General Conditions of the Contract Between Owner and Design/Builder are referred to herein as the General Conditions.
- 14.02. Terms used in this Agreement will have the meanings indicated in the General Conditions.
- 14.03. No assignment by a party hereto of any rights under or interests in the Contract Documents will be binding on another party hereto without the written consent of the party sought to be bound; and, specifically but without limitation, moneys that may become due and moneys that are due may not be assigned without such consent (except to the extent that the effect of this restriction may be limited by law), and unless specifically stated to the contrary in any written consent to an assignment no assignment will release or discharge the assignor from any duty or responsibility under the Contract Documents.
- 14.04. Owner and Design/Builder each binds itself, its partners, successors, assigns and legal representatives to the other party hereto, its partners, successors, assigns, and legal representatives in respect to all covenants, agreements, and obligations contained in the Contract Documents.
- 14.05. Any provision or part of the Contract Documents held to be void or unenforceable under any Law or Regulation shall be deemed stricken, and all remaining provisions shall continue to be valid and binding upon Owner and Design/Builder, who agree that the Contract Documents shall be reformed to replace such stricken provision or part thereof with a valid and enforceable provision that comes as close as possible to expressing the intention of the stricken provision.
- 14.06. Government Regulations: The following clauses, where applicable, are incorporated in this Agreement by reference as is fully set out; the Equal Opportunity Clause prescribed in 41 CFR 60-1.40, the Affirmative Action Clause prescribed in 41 CFR 60-250.4, regarding veterans and veterans of the Vietnam Era, and the Affirmative Action Clause for Handicapped Workers prescribed in 41 CFR 60-741.4.
- 14.07. Local Resources Goal: Owner acknowledges the benefit that the local community receives through utilization of local contractors, laborers, and suppliers. Design/Builder has submitted a local resources utilization plan which is included in Exhibit C (Local Resources Utilization Plan). Design/Builder will make a good faith effort to employ qualified individuals who are, and have been for at least one year out of the three years prior to the opening of Proposals, residents of Monterey County, San Benito County, or Santa Cruz County in sufficient numbers so that no less than fifty percent of Design/Builder's total work force, including any Subcontractor work force (with exception of specialty subcontractor items), measured in labor work hours, is comprised of residents of such counties. Design/Builder must comply with such plan

and shall monitor and report at least quarterly the continued implementation of the Local Resources Utilization Plan throughout the performance of this Contract.

14.08 Public Funding/Labor Law Compliance.

A. Prevailing Wages and Labor Compliance Program. Design/Builder shall pay prevailing wage rates. The general prevailing wage rates for the Work are available on the California Department of Industrial Relations' website at <http://www.dir.ca.gov>. Further, the Work may be subject to a statutory requirement to adopt and enforce a labor compliance program for the monitoring and enforcement of prevailing wage requirements. Design/Builder shall, at no additional cost to Owner, comply with any applicable labor law and labor compliance program requirements. Design/Builder is responsible for all failures by Subcontractors to comply with labor compliance program requirements. Pursuant to section 1773 of the California Labor Code, the general prevailing wage rates in the county in which the Work is to be done have been determined by the Director of the California Department of Industrial Relations.

B. CWSRF Funding Responsibilities.

1. Application and Submittals. Owner shall submit all filings, applications and reports necessary to obtain reimbursement from the Clean Water State Revolving Fund ("CWSRF") for the Project.

2. Design/Builder Responsibilities. Design/Builder shall be responsible for cooperating with and providing reasonable assistance to Owner in all activities related to the loan agreement regarding the CWSRF loan from the State Water Resources Control Board ("SWRCB") to the Owner to partially fund the Project ("CWSRF Loan Agreement") including:

(a) coordinating with Owner or Owner's consultant on the schedule and content of the submittals required for the CWSRF program;

(b) assisting Owner or Owner's consultant in developing and furnishing all necessary and reasonably required supporting material;

(c) supplying all data and information which may be reasonably required;

(d) familiarizing itself with the terms and conditions of the CWSRF program relating to construction activities and practices;

(e) complying with the terms and conditions of the CWSRF Loan Agreement or other financing document required by the CWSRF program or by applicable law with respect to construction activities and practices, including requirements described in Exhibits A and B;

(f) attending meetings, as necessary, with SWRCB and other governmental bodies; and

(g) taking all other actions reasonably requested by Owner in order to assist and support Owner related to the CWSRF financing for the Project.

Design/Builder shall take all reasonable actions necessary to comply with the conditions to disbursement of proceeds of the CWSRF Loan Agreement and to maximize Owner's eligibility to receive timely reimbursement under the CWSRF Loan Agreement. Design/Builder shall perform its CWSRF-related responsibilities in a manner which complies with all CWSRF program requirements.

3. Data and Information. All data, information and action required to be supplied or taken in connection with any CWSRF financing shall be supplied and taken on a timely basis considering the CWSRF requirements at Design/Builder's sole cost and expense. The data and information supplied by Design/Builder to Owner or Owner's consultant and the SWRCB in connection therewith shall be correct and complete in all material respects and shall be submitted in draft form to Owner or Owner's consultant sufficiently in advance to allow full and meaningful review and comment by Owner. Design/Builder shall not be entitled to any schedule or price relief or escalation which result from a delay due to the submission of materially incorrect or incomplete information. Owner reserves the right to reject, modify, alter, amend, delete or supplement any information supplied by Design/Builder pursuant to this Section.

4. CWSRF Requirements. Owner is informed that in order to obtain CWSRF financing for the Project: (a) American Iron and Steel (AIS) requirements will apply; (b) the State Water Resources Control Board ("SWRCB") CWSRF policy will apply; and (c) the SWRCB applies USEPA guidance on AIS requirements. Design/Builder agrees to cooperate with Owner to meet all CWSRF financing requirements applicable to the Project and Design/Builder has included all costs necessary to comply with AIS requirements in the Contract Price.

14.09 Design/Builder accepts this Agreement and will supply any information relating to federal or state laws, rules or regulations relating to the above.



IN WITNESS WHEREOF, Owner and Design/Builder have signed this Agreement in duplicate. One counterpart each has been delivered to Owner and Design/Builder. All portions of the Contract Documents have been signed, initialed, or identified by Owner and Design/Builder.

This Agreement will be effective on \_\_\_\_\_ (which is the Effective Date of the Agreement).

Owner:  
\_\_\_\_\_

Design/Builder:  
\_\_\_\_\_

By: \_\_\_\_\_

By: \_\_\_\_\_

[CORPORATE SEAL]

[CORPORATE SEAL]

Attest: \_\_\_\_\_

Attest: \_\_\_\_\_

Address for giving notices:  
\_\_\_\_\_  
\_\_\_\_\_  
\_\_\_\_\_

Address for giving notices:  
\_\_\_\_\_  
\_\_\_\_\_  
\_\_\_\_\_

(If Owner is a corporation, attach evidence of authority to sign. If Owner is a public body, attach evidence of authority to sign and resolution or other documents authorizing execution of this Agreement.)

Engineer License  
or Certificate No. \_\_\_\_\_  
(Where applicable)  
State: \_\_\_\_\_

Contractor License No. \_\_\_\_\_  
(Where applicable)  
State: \_\_\_\_\_

(If Design/Builder is a corporation, attach evidence of authority to sign.)

Designated Representative:

Designated Representative:

Name: \_\_\_\_\_  
Title: \_\_\_\_\_

Name: \_\_\_\_\_  
Title: \_\_\_\_\_

Address: \_\_\_\_\_  
\_\_\_\_\_

Address: \_\_\_\_\_  
\_\_\_\_\_

Phone: \_\_\_\_\_  
Fax: \_\_\_\_\_

Phone: \_\_\_\_\_  
Fax: \_\_\_\_\_

## EXHIBIT A



California State Water Resources Control Board  
Division of Financial Assistance  
1001 I Street • Sacramento, California 95814 • (916) 341-5700 FAX (916) 341-5707  
Mailing Address: P. O. Box 944212 • Sacramento, California • 94244-2120  
Internet Address: <http://www.waterboards.ca.gov>

### **Guidelines for Meeting the California State Revolving Fund (CASRF) Programs (Clean Water and Drinking Water SRF) Disadvantaged Business Enterprise Requirements**

The Disadvantaged Business Enterprise (DBE) Program is an outreach, education, and objectives program designed to increase the participation of DBEs in the Clean Water State Revolving Fund (CWSRF) and Drinking Water State Revolving Fund (DWSRF) Programs.

#### **How to Achieve the Purpose of the Program**

Recipients of CWSRF/DWSRF financing that are subject to the DBE requirements (recipients) are required to seek, and are encouraged to use, DBEs for their procurement needs. Recipients should award a "fair share" of sub-agreements to DBEs. This applies to all sub-agreements for equipment, supplies, construction, and services.

The key functional components of the DBE Program are as follows:

- Fair Share Objectives
- DBE Certification
- Six Good Faith Efforts
- Contract Administration Requirements
- DBE Reporting

#### **Disadvantaged Business Enterprises are:**

- Entities owned and/or controlled by socially and economically disadvantaged individuals as described by Title X of the Clean Air Act Amendments of 1990 (42 U.S.C. 7601 note) (10% statute), and Public Law 102-389 (42 U.S.C. 4370d) (8% statute), respectively;
- Minority Business Enterprise (MBE) - entities that are at least 51% owned and/or controlled by a socially and economically disadvantaged individual as described by Title X of the Clean Air Act Amendments of 1990 (42 U.S.C. 7601 note), and Public Law 102-389 (42 U.S.C. 4370d), respectively;
- Women Business Enterprise (WBE) - entities that are at least 51% owned and/or controlled by women;
- Small Business Enterprise (SBE);
- Small Business in a Rural Area (SBRA);
- Labor Surplus Area Firm (LSAF); or
- Historically Underutilized Business (HUB) Zone Small Business Concern or a concern under a successor program.

#### **Certifying DBE Firms:**

Under the DBE Program, entities can no longer self-certify and contractors and sub-contractors must be certified at bid opening. Contractors and sub-contractors must provide to the CASRF recipient proof of DBE certification. Certifications will be accepted from the following:

- The U.S. Environmental Protection Agency (USEPA)
- The Small Business Administration (SBA)
- The Department of Transportation's State implemented DBE Certification Program (with U.S. citizenship)
- Tribal, State and Local governments
- Independent private organization certifications

If an entity holds one of these certifications, it is considered acceptable for establishing status under the DBE Program.

## EXHIBIT A

### **Six Good Faith Efforts (GFE)**

All CWSRF/DWSRF financing recipients are required to complete and ensure that the prime contractor complies with the GFE below to ensure that DBEs have the opportunity to compete for financial assistance dollars.

1. Ensure DBEs are made aware of contracting opportunities to the fullest extent practical through outreach and recruitment activities. For Tribal, State and Local Government Recipients, this will include placing DBEs on solicitation lists and soliciting them whenever they are potential sources.
2. Make information on forthcoming opportunities available to DBEs. Posting solicitations for bids or proposals for a minimum of 30 calendar days in a local newspaper, before the bid opening date.
3. Consider in the contracting process whether firms competing for large contracts could subcontract with DBEs.
4. Encourage contracting with a group of DBEs when a contract is too large for one firm to handle individually.
5. Use the services of the SBA **and/or** Minority Business Development Agency (MBDA) of the US Department of Commerce.
6. If the prime contractor awards subcontracts, require the prime contractor to take the above steps.

The forms listed in the table below and attached to these guidelines; must be completed and submitted with the GFE:

FORM NUMBER	FORM NAME	REQUIREMENT	PROVIDED BY	COMPLETED BY	SUBMITTED TO
SWRCB Form 4500-2 or EPA Form	DBE Sub-Contractor Participation Form	As Needed to Report Issues	Recipient	Sub-contractor	EPA DBE Coordinator
SWRCB Form 4500-3 or EPA Form	DBE Sub-Contractor Performance Form	Include with Bid or Proposal Package	Prime Contractor	Sub-Contractor	SWRCB by Recipient
SWRCB Form 4500-4 or EPA Form	DBE Sub-Contractor Utilization Form	Include with Bid or Proposal Package	Recipient	Prime Contractor	SWRCB by Recipient

**The completed forms must be submitted with each Bid or Proposal.** The recipient shall review the bidder's documents closely to determine that the GFE was performed **prior** to bid or proposal opening date. Failure to complete the GFE and to substantiate completion of the GFE before the bid opening date could jeopardize CWSRF/DWSRF financing for the project. The following situations and circumstances require action as indicated:

1. If the apparent successful low bidder was rejected, a complete explanation must be provided.
2. Failure of the apparent low bidder to **perform** the GFE **prior** to bid opening constitutes a non-responsive bid. The construction contract may then be awarded to the next low, responsive, and responsible bidder that meets the requirements or the Recipient may re-advertise the project.
3. If there is a bid dispute, all disputes shall be settled **prior** to submission of the Final Budget Approval Form.

### **Administration Requirements**

- A recipient of CWSRF/DWSRF financing must require entities receiving funds to create and maintain a Bidders List if the recipient of the financing agreement is subject to, or chooses to follow, competitive bidding requirements.
- The Bidders list must include all firms that bid or quote on prime contracts, or bid or quote on subcontracts, including both DBEs and non-DBEs.

## EXHIBIT A

- Information retained on the Bidder's List must include the following:
  1. Entity's name with point of contact;
  2. Entity's mailing address and telephone number;
  3. The project description on which the entity bid or quoted and when;
  4. Amount of bid/quote; and
  5. Entity's status as a DBE or non-DBE.
- The Bidders List must be kept until the recipient is no longer receiving funding under the agreement.
- The recipient shall include Bidders List as part of the Final Budget Approval Form.
- A recipient must require its prime contractor to pay its subcontractor for satisfactory performance no more than 30 days from the prime contractor's receipt of payment from the Recipient.
- A recipient must be notified in writing by its prime contractor prior to any termination of a DBE subcontractor by the prime contractor.
- If a DBE subcontractor fails to complete work under the subcontract for any reason, the recipient must require the prime contractor to employ the six GFEs if soliciting a replacement subcontractor.
- A recipient must require its prime contractor to employ the six GFEs even if the prime contractor has achieved its fair share objectives.

### **Reporting Requirements**

For the duration of the construction contract(s), the recipient is required to submit to the State Water Resources Control Board DBE reports annually by October 10 of each fiscal year on the attached Utilization Report form (UR-334). Failure to provide this information as stipulated in the financial agreement language may be cause for withholding disbursements.

### **CONTACT FOR MORE INFORMATION**

SWRCB, CASRF – Barbara August (916) 341-6952 [barbara.august@waterboards.ca.gov](mailto:barbara.august@waterboards.ca.gov)

US EPA, Region 9 – Joe Ochab (415) 972-3761 [ochab.joe@epa.gov](mailto:ochab.joe@epa.gov)

## EXHIBIT A

*This page intentionally left blank.*



**Disadvantaged Business Enterprise (DBE) Program  
DBE Subcontractor Participation Form**

A Financial Assistance Agreement Recipient must require its prime contractors to provide this form to its DBE subcontractors. This form gives a DBE<sup>1</sup> subcontractor<sup>2</sup> the opportunity to describe work received and/or report any concerns regarding the funded project (e.g., in areas such as termination by prime contractor, late payments, etc.). The DBE subcontractor can, as an option, complete and submit this form to the DBE Coordinator at any time during the project period of performance.

Subcontractor Name		Project Name	
Bid / Proposal No.	Assistance Agreement ID No. (if known)	Point of Contact	
Address			
Telephone No.		Email Address	
Prime Contractor Name		Issuing/Funding Entity	

Contract Item Number	Description of Work Received from the Prime Contractor Involving Construction, Services, Equipment or Supplies	Amount Received by Prime Contractor

<sup>1</sup> A DBE is a Disadvantaged, Minority, or Woman Business Enterprise that has been certified by an entity from which EPA accepts certifications as described in 40 CFR 33.204-33.2015 or certified by EPA. EPA accepts certifications from entities that meet or exceed EPA certification standards as described in 40 CFR 33.202.

<sup>2</sup> Subcontractor is defined as a company, firm, joint venture, or individual who enters into an agreement with a contractor to provide services pursuant to an award of financial assistance.

# EXHIBIT A

Please use the space below to report any concerns regarding the above funded project:

Subcontractor Signature	Print Name
Title	Date

The public reporting and record keeping burden for this collection of information is estimated to average three (3) hours per response. Send comments on the Agency's need for this information, the accuracy of the provided burden estimates, and any suggested methods for minimizing respondent burden, including through the use of automated collection techniques to the Director, Collection Strategies Division, U.S. Environmental Protection Agency (2822T), 1200 Pennsylvania Ave., NW, Washington, D.C. 20460. Do not send the completed form to this address.

**Send completed Form 4500-2 to:**

Mr. Joe Ochab, DBE Coordinator  
US EPA, Region 9  
75 Hawthorne Street  
San Francisco, CA 94105



***Disadvantaged Business Enterprise (DBE) Program  
DBE Subcontractor Performance Form***

This form is intended to capture the DBE<sup>1</sup> subcontractor's<sup>2</sup> description of work to be performed and the price of the work submitted to the prime contractor. A Financial Assistance Agreement Recipient must require its prime contractor to have its DBE subcontractors complete this form and include all completed forms in the prime contractor's bid or proposal package.

Subcontractor Name		Project Name	
Bid / Proposal No.	Assistance Agreement ID No. (if known)	Point of Contact	
Address			
Telephone No.		Email Address	
Prime Contractor Name		Issuing/Funding Entity	

Contract Item Number	Description of Work Submitted from the Prime Contractor Involving Construction, Services, Equipment or Supplies	Price of Work Submitted to the Prime Contractor
DBE Certified By:    . DOT    . SBA Other: _____		Meets/exceeds EPA certification standards? YES      NO      Unknown

<sup>1</sup> A DBE is a Disadvantaged, Minority, or Woman Business Enterprise that has been certified by an entity from which EPA accepts certifications as described in 40 CFR 33.204-33.2015 or certified by EPA. EPA accepts certifications from entities that meet or exceed EPA certification standards as described in 40 CFR 33.202.

<sup>2</sup> Subcontractor is defined as a company, firm, joint venture, or individual who enters into an agreement with a contractor to provide services pursuant to an award of financial assistance.



## EXHIBIT A

I certify under penalty of perjury that the forgoing statements are true and correct. Signing this form does not signify a commitment to utilize the subcontractors above. I am aware that in the event of a replacement of a subcontractor, I will adhere to the replacement requirements set forth in 40 CFR Part 33 Section 33.302 (c).

Prime Contractor Signature	Print Name
Title	Date

Subcontractor Signature	Print Name
Title	Date

The public reporting and record keeping burden for this collection of information is estimated to average three (3) hours per response. Send comments on the Agency's need for this information, the accuracy of the provided burden estimates, and any suggested methods for minimizing respondent burden, including through the use of automated collection techniques to the Director, Collection Strategies Division, U.S. Environmental Protection Agency (2822T), 1200 Pennsylvania Ave., NW, Washington, D.C. 20460. Do not send the completed form to this address.



**Disadvantaged Business Enterprise (DBE) Program  
DBE Subcontractor Utilization Form**

This form is intended to capture the prime contractor's actual and/or anticipated use of identified certified DBE<sup>1</sup> subcontractor's<sup>2</sup> and the estimated dollar amount of each subcontract. A Financial Assistance Agreement Recipient must require its prime contractors to complete this form and include it in the bid or proposal package. Prime contractors should also maintain a copy of this form on file.

Prime Contractor Name		Project Name	
Bid / Proposal No.	Assistance Agreement ID No. (if known)	Point of Contact	
Address			
Telephone No.		Email Address	
Issuing/Funding Entity			

I have identified potential DBE certified subcontractors.      YES      NO If yes, please complete the table below. If no, please explain:			
<b>Subcontractor Name/ Company Name</b>	<b>Company Address / Phone / Email</b>	<b>Estimated Dollar Amount</b>	<b>Currently DBE Certified?</b>

--Continue on back if needed--

<sup>1</sup> A DBE is a Disadvantaged, Minority, or Woman Business Enterprise that has been certified by an entity from which EPA accepts certifications as described in 40 CFR 33.204-33.2015 or certified by EPA. EPA accepts certifications from entities that meet or exceed EPA certification standards as described in 40 CFR 33.202.  
<sup>2</sup> Subcontractor is defined as a company, firm, joint venture, or individual who enters into an agreement with a contractor to provide services pursuant to an award of financial assistance.

## EXHIBIT A

I certify under penalty of perjury that the forgoing statements are true and correct. Signing this form does not signify a commitment to utilize the subcontractors above. I am aware that in the event of a replacement of a subcontractor, I will adhere to the replacement requirements set forth in 40 CFR Part 33 Section 33.302 (c).

Prime Contractor Signature	Print Name
Title	Date

The public reporting and record keeping burden for this collection of information is estimated to average three (3) hours per response. Send comments on the Agency's need for this information, the accuracy of the provided burden estimates, and any suggested methods for minimizing respondent burden, including through the use of automated collection techniques to the Director, Collection Strategies Division, U.S. Environmental Protection Agency (2822T), 1200 Pennsylvania Ave., NW, Washington, D.C. 20460. Do not send the completed form to this address.



**STATE WATER RESOURCES CONTROL BOARD – DIVISION OF FINANCIAL ASSISTANCE  
DISADVANTAGED BUSINESS ENTERPRISE (DBE) UTILIZATION  
CALIFORNIA STATE REVOLVING FUNDS (CASRF)  
FORM UR-334**

<b>1. Grant/Finance Agreement Number:</b>		<b>2. Annual Reporting Period</b> 10/1/ through 09/30/		<b>3. Purchase Period of Financing Agreement:</b>	
<b>4. Total Payments Paid to Prime Contractor or Sub-Contractors During Current Reporting Period: \$</b>					
<b>5. Recipient's Name and Address:</b>				<b>6. Recipient's Contact Person and Phone Number:</b>	
<b>7. List All DBE Payments Paid by Recipient or Prime Contractor During Current Reporting Period:</b>					
Payment or Purchase Paid by Recipient or Prime Contractor	Amount Paid to Any DBE Contractor or Sub-Contractor For Service Provided to Recipient		Date of Payment (MM/DD/YY)	Procurement Type Code** (see below)	Name and Address of DBE Contractor of Sub-Contractor or Vendor
	MBE	WBE			
<b>8. Initial here if no DBE contractors or sub-contractors paid during current reporting period:</b>					
<b>9. Initial here if all procurements for this contract are completed:</b>					
<b>10. Comments:</b>					
<b>11. Signature and Title of Recipient's Authorized Representative</b>				<b>12. Date</b>	

**Email Form UR-334 to:**

[DrinkingWaterSRF@waterboards.ca.gov](mailto:DrinkingWaterSRF@waterboards.ca.gov) OR [CleanWaterSRF@waterboards.ca.gov](mailto:CleanWaterSRF@waterboards.ca.gov)

**Questions may be directed to:**

Barbara August, SWRCB  
[Barbara.August@waterboards.ca.gov](mailto:Barbara.August@waterboards.ca.gov)  
 Phone: (916) 341-6952  
 Fax: (916) 327-7469

**\*\*Procurement Type:**

1. Construction
2. Supplies
3. Services (includes business services; professional services; repair services and personnel services)
4. Equipment

## EXHIBIT A

### STATE WATER RESOURCES CONTROL BOARD - DIVISION OF FINANCIAL ASSISTANCE DISADVANTAGED BUSINESS ENTERPRISE (DBE) UTILIZATION CALIFORNIA STATE REVOLVING FUNDS

#### INSTRUCTIONS FOR COMPLETING FORM UR-334

- Box 1** Grant or Financing Agreement Number.
- Box 2** Annual reporting period.
- Box 3** Enter the dates between which you made procurements under this financing agreement or grant.
- Box 4** Enter the total amount of payments paid to the contractor or sub-contractors during this reporting period.
- Box 5** Enter Recipient's Name and Address.
- Box 6** Enter Recipient's Contact Name and Phone Number.
- Box 7** Enter details for the **DBE purchases only** and be sure to limit them to the current period. 1) Use either an "R" or a "C" to represent "Recipient" or "Contractor." 2) Enter a dollar total for DBE and total the two columns at the bottom of the section. 3) Provide the payment date. 4) Enter a product type choice from those at the bottom of the page. 5) List the vendor name and address in the right-hand column
- Box 8** Initial here if no DBE contractors or sub-contractors were paid during this reporting period.
- Box 9** Initial this box only if all purchases under this financing agreement or grant have been completed during this reporting period or a previous period. If you initial this box, we will no longer send you a survey.
- Box 10** This box is for explanatory information or questions.
- Box 11** Provide an authorized representative signature.
- Box 12** Enter the date form completed.

## EXHIBIT B

### DAVIS BACON REQUIREMENTS

The Recipient shall have the primary responsibility to maintain payroll records as described in Section 3(ii)(A), below and for compliance as described in Section 5.

Requirements under the Consolidated Appropriations Act, 2014 (P.L. 113-76)

For Recipients That Are Governmental Entities:

If a Recipient has questions regarding when Davis Bacon (DB) applies, obtaining the correct DB wage determinations, DB provisions, or compliance monitoring, it may contact the State Water Board.

The Recipient may also obtain additional guidance from DOL's web site at <http://www.dol.gov/whd/>

#### 1. Applicability of the Davis- Bacon (DB) prevailing wage requirements.

Under the FY 2014 Consolidated Appropriation Act, DB prevailing wage requirements apply to the construction, alteration, and repair of treatment works carried out in whole or in part with assistance made available by a State water pollution control revolving fund and to any construction project carried out in whole or in part by assistance made available by a drinking water treatment revolving loan fund. If the Recipient encounters a unique situation at a site that presents uncertainties regarding DB applicability, the Recipient must discuss the situation with the State Water Board State before authorizing work on that site.

#### 2. Obtaining Wage Determinations.

- (a) Recipients shall obtain the wage determination for the locality in which a covered activity subject to DB will take place prior to issuing requests for bids, proposals, quotes or other methods for soliciting contracts (solicitation) for activities subject to DB. These wage determinations shall be incorporated into solicitations and any subsequent contracts. Prime contracts must contain a provision requiring that subcontractors follow the wage determination incorporated into the prime contract.
  - (i) While the solicitation remains open, the Recipient shall monitor [www.wdol.gov](http://www.wdol.gov) weekly to ensure that the wage determination contained in the solicitation remains current. The Recipients shall amend the solicitation if DOL issues a modification more than 10 days prior to the closing date (i.e. bid opening) for the solicitation. If DOL modifies or supersedes the applicable wage determination less than 10 days prior to the closing date, the Recipients may request a finding from the State Water Board that there is not a reasonable time to notify interested contractors of the modification of the wage determination. The State Water Board will provide a report of its findings to the Recipient.
  - (ii) If the Recipient does not award the contract within 90 days of the closure of the solicitation, any modifications or supersedes DOL makes to the wage determination contained in the solicitation shall be effective unless the State Water Board, at the request of the Recipient, obtains an extension of the 90 day period from DOL pursuant to 29 CFR 1.6(c)(3)(iv). The Recipient shall monitor [www.wdol.gov](http://www.wdol.gov) on a weekly basis if it does not award the contract within 90 days of closure of the solicitation to ensure that wage determinations contained in the solicitation remain current.
- (b) If the Recipient carries out activity subject to DB by issuing a task order, work assignment or similar instrument to an existing contractor (ordering instrument) rather than by publishing a solicitation, the Recipient shall insert the appropriate DOL wage determination from [www.wdol.gov](http://www.wdol.gov) into the ordering instrument.

## EXHIBIT B

### DAVIS BACON REQUIREMENTS

- (c) Recipients shall review all subcontracts subject to DB entered into by prime contractors to verify that the prime contractor has required its subcontractors to include the applicable wage determinations.
  - (d) As provided in 29 CFR 1.6(f), DOL may issue a revised wage determination applicable to a Recipient's contract after the award of a contract or the issuance of an ordering instrument if DOL determines that the Recipient has failed to incorporate a wage determination or has used a wage determination that clearly does not apply to the contract or ordering instrument. If this occurs, the Recipient shall either terminate the contract or ordering instrument and issue a revised solicitation or ordering instrument or incorporate DOL's wage determination retroactive to the beginning of the contract or ordering instrument by change order. The Recipient's contractor must be compensated for any increases in wages resulting from the use of DOL's revised wage determination.
3. Contract and Subcontract provisions.
- (a) The Recipient shall insure that the Recipient(s) shall insert in full in any contract in excess of \$2,000 which is entered into for the actual construction, alteration and/or repair, including painting and decorating, of a treatment work under the CWSRF or a construction project under the DWSRF financed in whole or in part from Federal funds or in accordance with guarantees of a Federal agency or financed from funds obtained by pledge of any contract of a Federal Agency to make a loan, grant or annual contribution (except where a different meaning is expressly indicated), and which is subject to the labor standards provisions of any of the acts listed in § 5.1 or the FY 2014 Consolidated Appropriations Act, the following clauses:
    - (1) Minimum wages.
      - (i) All laborers and mechanics employed or working upon the site of the work will be paid unconditionally and not less often than once a week, and without subsequent deduction or rebate on any account (except such payroll deductions as are permitted by regulations issued by the Secretary of Labor under the Copeland Act (29 CFR part 3)), the full amount of wages and bona fide fringe benefits (or cash equivalents thereof) due at time of payment computed at rates not less than those contained in the wage determination of the Secretary of Labor which is attached hereto and made a part hereof, regardless of any contractual relationship which may be alleged to exist between the contractor and such laborers and mechanics. Contributions made or costs reasonably anticipated for bona fide fringe benefits under section 1(b) (2) of the Davis-Bacon Act on behalf of laborers or mechanics are considered wages paid to such laborers or mechanics, subject to the provisions of paragraph (a) (1) (iv) of this section; also, regular contributions made or costs incurred for more than a weekly period (but not less often than quarterly) under plans, funds, or programs which cover the particular weekly period, are deemed to be constructively made or incurred during such weekly period. Such laborers and mechanics shall be paid the appropriate wage rate and fringe benefits on the wage determination for the classification of work actually performed, without regard to skill, except as provided in § 5.5(a)(4). Laborers or mechanics performing work in more than one classification may be compensated at the rate specified for each classification for the time actually worked therein: Provided that the employer's payroll records accurately set forth the time spent in each classification in which work is performed. The wage determination (including any additional classification and wage rates conformed under paragraph (a)(1)(ii) of this section) and the Davis-Bacon poster (WH-1321) shall be posted at all times by the contractor and its subcontractors at the site of the work in a prominent and accessible place where it can be easily seen by the workers. Recipients may obtain wage determinations from the U.S. Department of Labor's web site, [www.dol.gov](http://www.dol.gov).

## EXHIBIT B

### DAVIS BACON REQUIREMENTS

- (ii)(A) The Recipient(s), on behalf of EPA, shall require that any class of laborers or mechanics, including helpers, which is not listed in the wage determination and which is to be employed under the contract shall be classified in conformance with the wage determination. The State award official shall approve a request for an additional classification and wage rate and fringe benefits therefore only when the following criteria have been met:
- (1) The work to be performed by the classification requested is not performed by a classification in the wage determination; and
  - (2) The classification is utilized in the area by the construction industry; and
  - (3) The proposed wage rate, including any bona fide fringe benefits, bears a reasonable relationship to the wage rates contained in the wage determination.
- (B) If the contractor and the laborers and mechanics to be employed in the classification (if known), or their representatives, and the Recipient(s) agree on the classification and wage rate (including the amount designated for fringe benefits where appropriate), documentation of the action taken and the request, including the local wage determination shall be sent by the Recipient (s) to the State award official. The State award official will transmit the request, to the Administrator of the Wage and Hour Division, Employment Standards Administration, U.S. Department of Labor, Washington, DC 20210 and to the EPA DB Regional Coordinator concurrently. The Administrator, or an authorized representative, will approve, modify, or disapprove every additional classification request within 30 days of receipt and so advise the State award official or will notify the State award official within the 30-day period that additional time is necessary.
- (C) In the event the contractor, the laborers or mechanics to be employed in the classification or their representatives, and the Recipient(s) do not agree on the proposed classification and wage rate (including the amount designated for fringe benefits, where appropriate), the award official shall refer the request and the local wage determination, including the views of all interested parties and the recommendation of the State award official, to the Administrator for determination. The request shall be sent to the EPA DB Regional Coordinator concurrently. The Administrator, or an authorized representative, will issue a determination within 30 days of receipt of the request and so advise the contracting officer or will notify the contracting officer within the 30-day period that additional time is necessary.
- (D) The wage rate (including fringe benefits where appropriate) determined pursuant to paragraphs (a)(1)(ii)(B) or (C) of this section, shall be paid to all workers performing work in the classification under this contract from the first day on which work is performed in the classification.
- (iii) Whenever the minimum wage rate prescribed in the contract for a class of laborers or mechanics includes a fringe benefit which is not expressed as an hourly rate, the contractor shall either pay the benefit as stated in the wage determination or shall pay another bona fide fringe benefit or an hourly cash equivalent thereof.
- (iv) If the contractor does not make payments to a trustee or other third person, the contractor may consider as part of the wages of any laborer or mechanic the amount of any costs reasonably anticipated in providing bona fide fringe benefits under a plan or program, Provided, That the Secretary of Labor has found, upon the written request of the contractor, that the applicable standards of the Davis-Bacon Act have been met. The Secretary of Labor may require the contractor to set aside in a separate account assets for the meeting of obligations under the plan or program.



## EXHIBIT B

### DAVIS BACON REQUIREMENTS

- (2) Withholding. The Recipient(s), shall upon written request of the EPA Award Official or an authorized representative of the Department of Labor, withhold or cause to be withheld from the contractor under this contract or any other Federal contract with the same prime contractor, or any other federally-assisted contract subject to Davis-Bacon prevailing wage requirements, which is held by the same prime contractor, so much of the accrued payments or advances as may be considered necessary to pay laborers and mechanics, including apprentices, trainees, and helpers, employed by the contractor or any subcontractor the full amount of wages required by the contract. In the event of failure to pay any laborer or mechanic, including any apprentice, trainee, or helper, employed or working on the site of the work, all or part of the wages required by the contract, the (Agency) may, after written notice to the contractor, sponsor, applicant, or owner, take such action as may be necessary to cause the suspension of any further payment, advance, or guarantee of funds until such violations have ceased.
- (3) Payrolls and basic records.
  - (i) Payrolls and basic records relating thereto shall be maintained by the contractor during the course of the work and preserved for a period of three years thereafter for all laborers and mechanics working at the site of the work. Such records shall contain the name, address, and social security number of each such worker, his or her correct classification, hourly rates of wages paid (including rates of contributions or costs anticipated for bona fide fringe benefits or cash equivalents thereof of the types described in section 1(b) (2)(B) of the Davis-Bacon Act), daily and weekly number of hours worked, deductions made and actual wages paid. Whenever the Secretary of Labor has found under 29 CFR 5.5(a)(1)(iv) that the wages of any laborer or mechanic include the amount of any costs reasonably anticipated in providing benefits under a plan or program described in section 1(b)(2)(B) of the Davis-Bacon Act, the contractor shall maintain records which show that the commitment to provide such benefits is enforceable, that the plan or program is financially responsible, and that the plan or program has been communicated in writing to the laborers or mechanics affected, and records which show the costs anticipated or the actual cost incurred in providing such benefits. Contractors employing apprentices or trainees under approved programs shall maintain written evidence of the registration of apprenticeship programs and certification of trainee programs, the registration of the apprentices and trainees, and the ratios and wage rates prescribed in the applicable programs.
  - (ii)(A) The contractor shall submit weekly, for each week in which any contract work is performed, a copy of all payrolls to the Recipient, that is, the entity that receives the sub-grant or loan from the State capitalization grant recipient. Such documentation shall be available on request of the State recipient or EPA. As to each payroll copy received, the Recipient shall provide written confirmation in a form satisfactory to the State indicating whether or not the project is in compliance with the requirements of 29 CFR 5.5(a)(1) based on the most recent payroll copies for the specified week. The payrolls shall set out accurately and completely all of the information required to be maintained under 29 CFR 5.5(a)(3)(i), except that full social security numbers and home addresses shall not be included on the weekly payrolls. Instead the payrolls shall only need to include an individually identifying number for each employee (e.g., the last four digits of the employee's social security number). The required weekly payroll information may be submitted in any form desired. Optional Form WH-347 is available for this purpose from the Wage and Hour Division Web site at <http://www.dol.gov/whd/forms/wh347instr.htm> or its successor site. The prime contractor is responsible for the submission of copies of payrolls by all subcontractors. Contractors and subcontractors shall maintain the full social security number and current address of each covered worker, and shall provide them upon request to the Recipient(s) for transmission to the State or EPA

## EXHIBIT B

### DAVIS BACON REQUIREMENTS

if requested by EPA, the State, the contractor, or the Wage and Hour Division of the Department of Labor for purposes of an investigation or audit of compliance with prevailing wage requirements. It is not a violation of this section for a prime contractor to require a subcontractor to provide addresses and social security numbers to the prime contractor for its own records, without weekly submission to the Recipient(s).

- (B) Each payroll submitted shall be accompanied by a "Statement of Compliance," signed by the contractor or subcontractor or his or her agent who pays or supervises the payment of the persons employed under the contract and shall certify the following:
  - (1) That the payroll for the payroll period contains the information required to be provided under § 5.5 (a) (3)(ii) of Regulations, 29 CFR part 5, the appropriate information is being maintained under § 5.5 (a)(3)(i) of Regulations, 29 CFR part 5, and that such information is correct and complete;
  - (2) That each laborer or mechanic (including each helper, apprentice, and trainee) employed on the contract during the payroll period has been paid the full weekly wages earned, without rebate, either directly or indirectly, and that no deductions have been made either directly or indirectly from the full wages earned, other than permissible deductions as set forth in Regulations, 29 CFR part 3;
  - (3) That each laborer or mechanic has been paid not less than the applicable wage rates and fringe benefits or cash equivalents for the classification of work performed, as specified in the applicable wage determination incorporated into the contract.
- (C) The weekly submission of a properly executed certification set forth on the reverse side of Optional Form WH-347 shall satisfy the requirement for submission of the "Statement of Compliance" required by paragraph (a)(3)(ii)(B) of this section.
- (D) The falsification of any of the above certifications may subject the contractor or subcontractor to civil or criminal prosecution under section 1001 of title 18 and section 231 of title 31 of the United States Code.
- (iii) The contractor or subcontractor shall make the records required under paragraph (a)(3)(i) of this section available for inspection, copying, or transcription by authorized representatives of the State, EPA or the Department of Labor, and shall permit such representatives to interview employees during working hours on the job. If the contractor or subcontractor fails to submit the required records or to make them available, the Federal agency or State may, after written notice to the contractor, sponsor, applicant, or owner, take such action as may be necessary to cause the suspension of any further payment, advance, or guarantee of funds. Furthermore, failure to submit the required records upon request or to make such records available may be grounds for debarment action pursuant to 29 CFR 5.12.
- (4) Apprentices and trainees--
  - (i) Apprentices. Apprentices will be permitted to work at less than the predetermined rate for the work they performed when they are employed pursuant to and individually registered in a bona fide apprenticeship program registered with the U.S. Department of Labor, Employment and Training Administration, Office of Apprenticeship Training, Employer and Labor Services, or with a State Apprenticeship Agency recognized by the Office, or if a person is employed in his or her first 90 days of probationary

## EXHIBIT B

### DAVIS BACON REQUIREMENTS

employment as an apprentice in such an apprenticeship program, who is not individually registered in the program, but who has been certified by the Office of Apprenticeship Training, Employer and Labor Services or a State Apprenticeship Agency (where appropriate) to be eligible for probationary employment as an apprentice. The allowable ratio of apprentices to journeymen on the job site in any craft classification shall not be greater than the ratio permitted to the contractor as to the entire work force under the registered program. Any worker listed on a payroll at an apprentice wage rate, who is not registered or otherwise employed as stated above, shall be paid not less than the applicable wage rate on the wage determination for the classification of work actually performed. In addition, any apprentice performing work on the job site in excess of the ratio permitted under the registered program shall be paid not less than the applicable wage rate on the wage determination for the work actually performed. Where a contractor is performing construction on a project in a locality other than that in which its program is registered, the ratios and wage rates (expressed in percentages of the journeyman's hourly rate) specified in the contractor's or subcontractor's registered program shall be observed. Every apprentice must be paid at not less than the rate specified in the registered program for the apprentice's level of progress, expressed as a percentage of the journeymen hourly rate specified in the applicable wage determination. Apprentices shall be paid fringe benefits in accordance with the provisions of the apprenticeship program. If the apprenticeship program does not specify fringe benefits, apprentices must be paid the full amount of fringe benefits listed on the wage determination for the applicable classification. If the Administrator determines that a different practice prevails for the applicable apprentice classification, fringes shall be paid in accordance with that determination. In the event the Office of Apprenticeship Training, Employer and Labor Services, or a State Apprenticeship Agency recognized by the Office, withdraws approval of an apprenticeship program, the contractor will no longer be permitted to utilize apprentices at less than the applicable predetermined rate for the work performed until an acceptable program is approved.

- (ii) Trainees. Except as provided in 29 CFR 5.16, trainees will not be permitted to work at less than the predetermined rate for the work performed unless they are employed pursuant to and individually registered in a program which has received prior approval, evidenced by formal certification by the U.S. Department of Labor, Employment and Training Administration. The ratio of trainees to journeymen on the job site shall not be greater than permitted under the plan approved by the Employment and Training Administration. Every trainee must be paid at not less than the rate specified in the approved program for the trainee's level of progress, expressed as a percentage of the journeyman hourly rate specified in the applicable wage determination. Trainees shall be paid fringe benefits in accordance with the provisions of the trainee program. If the trainee program does not mention fringe benefits, trainees shall be paid the full amount of fringe benefits listed on the wage determination unless the Administrator of the Wage and Hour Division determines that there is an apprenticeship program associated with the corresponding journeyman wage rate on the wage determination which provides for less than full fringe benefits for apprentices. Any employee listed on the payroll at a trainee rate who is not registered and participating in a training plan approved by the Employment and Training Administration shall be paid not less than the applicable wage rate on the wage determination for the classification of work actually performed. In addition, any trainee performing work on the job site in excess of the ratio permitted under the registered program shall be paid not less than the applicable wage rate on the wage determination for the work actually performed. In the event the Employment and Training Administration withdraws approval of a training program, the contractor will no longer be permitted to utilize trainees at less than the applicable predetermined rate for the work performed until an acceptable program is approved.

## EXHIBIT B

### DAVIS BACON REQUIREMENTS

- (iii) Equal employment opportunity. The utilization of apprentices, trainees and journeymen under this part shall be in conformity with the equal employment opportunity requirements of Executive Order 11246, as amended and 29 CFR part 30.
  - (5) Compliance with Copeland Act requirements. The contractor shall comply with the requirements of 29 CFR part 3, which are incorporated by reference in this contract.
  - (6) Subcontracts. The contractor or subcontractor shall insert in any subcontracts the clauses contained in 29 CFR 5.5(a)(1) through (10) and such other clauses as the EPA determines may be appropriate, and also a clause requiring the subcontractors to include these clauses in any lower tier subcontracts. The prime contractor shall be responsible for the compliance by any subcontractor or lower tier subcontractor with all the contract clauses in 29 CFR 5.5.
  - (7) Contract termination; debarment. A breach of the contract clauses in 29 CFR 5.5 may be grounds for termination of the contract, and for debarment as a contractor and a subcontractor as provided in 29 CFR 5.12.
  - (8) Compliance with Davis-Bacon and Related Act requirements. All rulings and interpretations of the Davis-Bacon and Related Acts contained in 29 CFR parts 1, 3, and 5 are herein incorporated by reference in this contract.
  - (9) Disputes concerning labor standards. Disputes arising out of the labor standards provisions of this contract shall not be subject to the general disputes clause of this contract. Such disputes shall be resolved in accordance with the procedures of the Department of Labor set forth in 29 CFR parts 5, 6, and 7. Disputes within the meaning of this clause include disputes between the contractor (or any of its subcontractors) and Recipient(s), State, EPA, the U.S. Department of Labor, or the employees or their representatives.
  - (10) Certification of eligibility.
    - (i) By entering into this contract, the contractor certifies that neither it (nor he or she) nor any person or firm who has an interest in the contractor's firm is a person or firm ineligible to be awarded Government contracts by virtue of section 3(a) of the Davis-Bacon Act or 29 CFR 5.12(a)(1).
    - (ii) No part of this contract shall be subcontracted to any person or firm ineligible for award of a Government contract by virtue of section 3(a) of the Davis-Bacon Act or 29 CFR 5.12(a)(1).
    - (iii) The penalty for making false statements is prescribed in the U.S. Criminal Code, 18 U.S.C. 1001.
4. Contract Provision for Contracts in Excess of \$100,000.
- (a) Contract Work Hours and Safety Standards Act. The Recipient shall insert the following clauses set forth in paragraphs (a)(1), (2), (3), and (4) of this section in full in any contract in an amount in excess of \$100,000 and subject to the overtime provisions of the Contract Work Hours and Safety Standards Act. These clauses shall be inserted in addition to the clauses required by Item 3, above or 29 CFR 4.6. As used in this paragraph, the terms laborers and mechanics include watchmen and guards.
    - (1) Overtime requirements. No contractor or subcontractor contracting for any part of the contract work which may require or involve the employment of laborers or mechanics shall require or permit any such laborer or mechanic in any workweek in which he or she is employed on such work to work in excess of forty hours in such workweek unless such

## EXHIBIT B

### DAVIS BACON REQUIREMENTS

laborer or mechanic receives compensation at a rate not less than one and one-half times the basic rate of pay for all hours worked in excess of forty hours in such workweek.

- (2) Violation; liability for unpaid wages; liquidated damages. In the event of any violation of the clause set forth in paragraph (a)(1) of this section the contractor and any subcontractor responsible therefore shall be liable for the unpaid wages. In addition, such contractor and subcontractor shall be liable to the United States (in the case of work done under contract for the District of Columbia or a territory, to such District or to such territory), for liquidated damages. Such liquidated damages shall be computed with respect to each individual laborer or mechanic, including watchmen and guards, employed in violation of the clause set forth in paragraph (a)(1) of this section, in the sum of \$10 for each calendar day on which such individual was required or permitted to work in excess of the standard workweek of forty hours without payment of the overtime wages required by the clause set forth in paragraph (a)(1) of this section.
  - (3) Withholding for unpaid wages and liquidated damages. The Recipient, upon written request of the EPA Award Official or an authorized representative of the Department of Labor, shall withhold or cause to be withheld, from any moneys payable on account of work performed by the contractor or subcontractor under any such contract or any other Federal contract with the same prime contractor, or any other federally-assisted contract subject to the Contract Work Hours and Safety Standards Act, which is held by the same prime contractor, such sums as may be determined to be necessary to satisfy any liabilities of such contractor or subcontractor for unpaid wages and liquidated damages as provided in the clause set forth in paragraph (b)(2) of this section.
  - (4) Subcontracts. The contractor or subcontractor shall insert in any subcontracts the clauses set forth in paragraph (a)(1) through (4) of this section and also a clause requiring the subcontractors to include these clauses in any lower tier subcontracts. The prime contractor shall be responsible for compliance by any subcontractor or lower tier subcontractor with the clauses set forth in paragraphs (a)(1) through (4) of this section.
- (b) In addition to the clauses contained in Item 3, above, in any contract subject only to the Contract Work Hours and Safety Standards Act and not to any of the other statutes cited in 29 CFR 5.1, the Recipient shall insert a clause requiring that the contractor or subcontractor shall maintain payrolls and basic payroll records during the course of the work and shall preserve them for a period of three years from the completion of the contract for all laborers and mechanics, including guards and watchmen, working on the contract. Such records shall contain the name and address of each such employee, social security number, correct classifications, hourly rates of wages paid, daily and weekly number of hours worked, deductions made, and actual wages paid. Further, the Recipient shall insert in any such contract a clause providing that the records to be maintained under this paragraph shall be made available by the contractor or subcontractor for inspection, copying, or transcription by authorized representatives of the USEPA, the Department of Labor, and the State Water Board, and the contractor or subcontractor will permit such representatives to interview employees during working hours on the job.

#### 5. Compliance Verification

- (a) The Recipient shall periodically interview a sufficient number of employees entitled to DB prevailing wages (covered employees) to verify that contractors or subcontractors are paying the appropriate wage rates. As provided in 29 CFR 5.6(a)(6), all interviews must be conducted in confidence. The Recipient must use Standard Form 1445 (SF 1445) or equivalent documentation to memorialize the interviews. Copies of the SF 1445 are available from EPA on request.

## EXHIBIT B

### DAVIS BACON REQUIREMENTS

- (b) The Recipient shall establish and follow an interview schedule based on its assessment of the risks of noncompliance with DB posed by contractors or subcontractors and the duration of the contract or subcontract. Recipients must conduct more frequent interviews if the initial interviews or other information indicated that there is a risk that the contractor or subcontractor is not complying with DB. Recipients shall immediately conduct interviews in response to an alleged violation of the prevailing wage requirements. All interviews shall be conducted in confidence.
- (c) The Recipient shall periodically conduct spot checks of a representative sample of weekly payroll data to verify that contractors or subcontractors are paying the appropriate wage rates. The Recipient shall establish and follow a spot check schedule based on its assessment of the risks of noncompliance with DB posed by contractors or subcontractors and the duration of the contract or subcontract. At a minimum, if practicable, the Recipient should spot check payroll data within two weeks of each contractor or subcontractor's submission of its initial payroll data and two weeks prior to the completion date the contract or subcontract . Recipients must conduct more frequent spot checks if the initial spot check or other information indicates that there is a risk that the contractor or subcontractor is not complying with DB. In addition, during the examinations the Recipient shall verify evidence of fringe benefit plans and payments there under by contractors and subcontractors who claim credit for fringe benefit contributions.
- (d) The Recipient shall periodically review contractors and subcontractors use of apprentices and trainees to verify registration and certification with respect to apprenticeship and training programs approved by either the U.S Department of Labor or a state, as appropriate, and that contractors and subcontractors are not using disproportionate numbers of, laborers, trainees and apprentices. These reviews shall be conducted in accordance with the schedules for spot checks and interviews described in Item 5(b) and (c) above.
- (e) Recipients must immediately report potential violations of the DB prevailing wage requirements to the EPA DB contact listed above and to the appropriate DOL Wage and Hour District Office listed at <http://www.dol.gov/contacts/whd/america2.htm>.

This document has important legal consequences; consultation with an attorney is encouraged with respect to its use or modification. This document should be adapted to the particular circumstances of the contemplated Project and the Controlling Law.

# STANDARD GENERAL CONDITIONS OF THE CONTRACT BETWEEN OWNER AND DESIGN/BUILDER

Prepared by

**ENGINEERS JOINT CONTRACT DOCUMENTS COMMITTEE**

and

Issued and Published Jointly by



PROFESSIONAL ENGINEERS IN PRIVATE PRACTICE  
*a practice division of the*  
NATIONAL SOCIETY OF PROFESSIONAL ENGINEERS

---

AMERICAN COUNCIL OF ENGINEERING COMPANIES

---

AMERICAN SOCIETY OF CIVIL ENGINEERS



These General Conditions have been prepared for use with either one of the two Agreements between Owner and Design/Builder (Nos. D-520 and D-525, 2002 Editions) of the Engineers Joint Contract Documents Committee. Their provisions are interrelated and a change in one may necessitate a change in the others. The suggested language and instructions contained in the Guide to Use of EJCDC Design/Build Documents (No. D-001, 2002 Edition) is also carefully interrelated with the language of these General Conditions. The Guide also contains comments concerning the use of the General Conditions.

**Copyright ©2002 National Society of Professional Engineers  
1420 King Street, Alexandria, VA 22314-2794**

**American Council of Engineering Companies  
1015 15th Street N.W., Washington, DC 20005**

**American Society of Civil Engineers  
1801 Alexander Bell Drive, Reston, VA 20191-4400**



**TABLE OF CONTENTS**

*Page*

ARTICLE 1 – DEFINITIONS AND TERMINOLOGY .....	1
1.01 Defined Terms .....	1
1.02 Terminology.....	3
ARTICLE 2 – PRELIMINARY MATTERS.....	4
2.01 Delivery of Bonds.....	4
2.02 Commencement of Contract Times; Notice to Proceed.....	4
2.03 Starting the Work.....	4
2.04 Before Starting the Work.....	4
2.05 Initial Conference.....	4
2.06 Initial Acceptance of Schedules.....	4
ARTICLE 3 – CONTRACT DOCUMENTS: INTENT, AMENDING, REUSE.....	5
3.01 Intent.....	5
3.02 Reference Standards.....	5
3.03 Resolving Discrepancies.....	5
3.04 Amending and Supplementing Contract Documents.....	5
3.05 Reuse of Documents.....	6
3.06 Electronic Data.....	6
ARTICLE 4 – AVAILABILITY OF LANDS; DIFFERING SITE CONDITIONS; REFERENCE POINTS; HAZARDOUS ENVIRONMENTAL CONDITIONS.....	6
4.01 Availability of Lands.....	6
4.02 Differing Site Conditions.....	6
4.03 Reference Points.....	7
4.04 Hazardous Environmental Condition at Site.....	7
ARTICLE 5 – BONDS AND INSURANCE.....	7
5.01 Performance, Payment and Other Bonds.....	8
5.02 Licensed Sureties and Insurers.....	8
5.03 Certificates of Insurance.....	8
5.04 Design/Builder's Liability Insurance.....	8
5.05 Owner's Liability Insurance.....	9
5.06 Property Insurance.....	9
5.07 Waiver of Rights.....	10
5.08 Receipt and Application of Insurance Proceeds.....	10
5.09 Acceptance of Bonds and Insurance; Option to Replace.....	11
5.10 Partial Utilization, Acknowledgment of Property Insurance.....	11
ARTICLE 6 – DESIGN/BUILDER'S RESPONSIBILITIES.....	11
6.01 Design Professional Services.....	11
6.02 Supervision and Superintendence of Construction.....	12
6.03 Labor, Working Hours.....	12
6.04 Services, Materials, and Equipment.....	12
6.05 Progress Schedule.....	12
6.06 Concerning Subcontractors, Suppliers and Others.....	12
6.07 Patent Fees and Royalties.....	13
6.08 Permits.....	13
6.09 Laws or Regulations.....	13
6.10 Taxes.....	14
6.11 Use of Site and Other Areas.....	14
6.12 Record Documents.....	14
6.13 Safety and Protection.....	14
6.14 Safety Representative.....	15
6.15 Hazard Communication Programs.....	15
6.16 Emergencies.....	15
6.17 Submittals.....	15
6.18 Continuing the Work.....	15
6.19 Post-Construction Phase.....	15
6.20 Design/Builder's General Warranty and Guarantee.....	16
6.21 Indemnification.....	16

ARTICLE 7 – OTHER CONSTRUCTION.....	16
7.01 Related Work at Site .....	16
7.02 Coordination .....	17
ARTICLE 8 – OWNER'S RESPONSIBILITIES .....	17
8.01 General.....	17
8.02 Insurance.....	18
8.03 Limitations on Owner's Responsibilities.....	18
8.04 Undisclosed Hazardous Environmental Condition .....	18
8.05 Resident Project Representation .....	18
8.06 Owner's Consultant .....	18
ARTICLE 9 – CHANGES IN THE WORK; CLAIMS.....	18
9.01 Authorized Changes in the Work.....	18
9.02 Unauthorized Changes in the Work .....	18
9.03 Claims .....	18
9.04 Execution of Change Orders .....	19
9.05 Notice to Sureties.....	19
ARTICLE 10 – COST OF THE WORK; CASH ALLOWANCES; UNIT PRICE WORK.....	19
10.01 Cost of the Work.....	19
10.02 Cash Allowances.....	21
10.03 Unit Prices.....	21
ARTICLE 11 – CHANGE OF CONTRACT PRICE; CHANGE OF CONTRACT TIMES .....	21
11.01 Change of Contract Price .....	21
11.02 Change of Contract Times .....	22
ARTICLE 12 – TESTS AND INSPECTIONS; CORRECTION, REMOVAL OR ACCEPTANCE OF DEFECTIVE CONSTRUCTION.....	23
12.01 Notice of Defects .....	23
12.02 Access to Construction.....	23
12.03 Tests and Inspections .....	23
12.04 Uncovering Construction .....	23
12.05 Owner May Stop Construction.....	23
12.06 Correction or Removal of Defective Construction.....	23
12.07 Correction Period .....	24
12.08 Acceptance of Defective Construction.....	24
12.09 Owner May Correct Defective Construction .....	24
ARTICLE 13 – PAYMENTS TO DESIGN/BUILDER AND COMPLETION.....	25
13.01 Schedule of Values .....	25
13.02 Application for Progress Payment .....	25
13.03 Progress Payments .....	25
13.04 Design/Builder's Warranty of Title.....	26
13.05 Substantial Completion.....	26
13.06 Partial Utilization .....	26
13.07 Final Inspection.....	26
13.08 Final Payment .....	27
13.09 Final Completion Delayed .....	27
13.10 Waiver of Claims .....	27
ARTICLE 14 – SUSPENSION OF WORK AND TERMINATION .....	27
14.01 Owner May Suspend Work.....	27
14.02 Owner May Terminate for Cause.....	28
14.03 Owner May Terminate for Convenience.....	28
14.04 Design/Builder May Stop Work or Terminate .....	28
ARTICLE 15 – DISPUTE RESOLUTION .....	29
ARTICLE 16 – MISCELLANEOUS .....	29
16.01 Giving Notice.....	29
16.02 Computation of Times .....	29
16.03 Cumulative Remedies .....	29
16.04 Survival of Obligations .....	29
16.05 Controlling Law.....	29

# STANDARD GENERAL CONDITIONS OF THE CONTRACT BETWEEN OWNER AND DESIGN/BUILDER

## ARTICLE 1 – DEFINITIONS AND TERMINOLOGY

---

### 1.01 Defined Terms

A. Wherever used in the Contract Documents and printed with initial or all capital letters, the following terms have the meanings indicated which are applicable to both the singular and plural thereof:

1. *Addenda* – Written or graphic instruments issued prior to the opening of Proposals which clarify, correct or change the Request for Proposals or the Contract Documents.

2. *Agreement* – The written instrument which is evidence of the agreement between Owner and Design/Builder covering the Work.

3. *Application for Payment* – The form which is to be used by Design/Builder in requesting progress or final payments and which is to be accompanied by such supporting documentation as is required by the Contract Documents.

4. *Asbestos* – Any material that contains more than one percent asbestos and is friable or is releasing asbestos fibers into the air above current action levels established by the United States Occupational Safety and Health Administration.

5. *Bonds* – Performance and payment bonds and other instruments of security.

6. *Change Order* – A written order which is signed by Design/Builder and Owner which authorizes an addition, deletion or revision in the Work, or an adjustment in the Contract Price or the Contract Times, issued on or after the Effective Date of the Agreement.

7. *Claim* – A demand or assertion by Owner or Design/Builder seeking an adjustment of Contract Price or Contract Times, or both, or other relief with respect to the terms of the Contract. A demand for money or services by a third party is not a claim.

8. *Conceptual Documents* – The drawings and specifications and/or other graphic or written materials, criteria and information concerning Owner's requirements for the Project, such as design objectives and constraints, space, capacity and performance requirements, flexibility and expandability, including those items enumerated in the

Request for Proposals which show or describe the character and scope of, or relate to, the Work to be performed or furnished and which have been prepared by or for Owner.

9. *Construction* – The result of performing or furnishing of labor, the furnishing and incorporating of materials and equipment into the Work and the furnishing of services (other than Design Professional Services) and documents, all as required by the Contract Documents.

10. *Construction Subagreement* – A written agreement between Design/Builder and a construction Subcontractor for provision of Construction.

11. *Contract* – The entire and integrated written agreement between Owner and Design/Builder concerning the Work. The Contract supersedes prior negotiations, representations, or agreements, whether written or oral.

12. *Contract Documents* – Those items so designated in the Agreement. Only printed or hard copies of the items listed in the Agreement are Contract Documents.

13. *Contract Price* – The moneys payable by Owner to Design/Builder for completion of the Work in accordance with the Contract Documents.

14. *Contract Times* – The numbers of days or the dates stated in the Agreement to (i) achieve Substantial Completion, and (ii) complete the Work so that it is ready for final payment in accordance with paragraph 13.08.

15. *Design/Builder* – The individual or entity with whom Owner has entered into the Agreement.

16. *Design Subagreement* – A written agreement between Design/Builder and a design professional for provision of Design Professional Services.

17. *Design Professional Services* – Services related to the preparation of Drawings, Specifications, and other design submittals specified by the Contract Documents and required to be performed by licensed design professionals, as well as other services provided by or for licensed design professionals during Bidding/Negotiating, Construction, or Operational phases.

18. *Drawings* – Those portions of the Contract Documents prepared by or for Design/Builder and approved by Owner consisting of drawings, diagrams,

illustrations, schedules and other data which show the scope, extent, and character of the Work.

19. *Effective Date of the Agreement* – The date indicated in the Agreement on which it becomes effective, but if no such date is indicated it means the date on which the Agreement is signed and delivered by the last of the two parties to sign and deliver.

20. *Field Order* – A written order issued by Owner which orders minor changes in the Work but which does not involve a change in the Contract Price or the Contract Times.

21. *Hazardous Environmental Condition* – The presence at the Site of Asbestos, Hazardous Waste, PCB's, Petroleum Products or Radioactive Materials in such quantities or circumstances that may present a substantial danger to persons or property exposed thereto on connection with the Work.

22. *Hazardous Waste* – The term Hazardous Waste shall have the meaning provided in Section 1004 of the Solid Waste Disposal Act (42 USC Section 6903) as amended from time to time.

23. *Laws or Regulations* – Any and all applicable laws, rules, regulations, ordinances, codes, and orders of any and all governmental bodies, agencies, authorities and courts having jurisdiction.

24. *Liens* – Charges, security interests or encumbrances upon real property or personal property.

25. *Milestone* – A principal event specified in the Contract Documents relating to an intermediate completion date or time prior to Substantial Completion of all the Work.

26. *Notice of Award* – The written notice by Owner to the successful proposer stating that upon compliance by the successful proposer with the conditions precedent included therein, within the time specified, Owner will sign and deliver the Agreement.

27. *Notice to Proceed* – A written notice given by Owner to Design/Builder fixing the date on which the Contract Times will commence to run and on which Design/Builder shall start to perform the Work.

28. *Owner* – The individual or entity with whom Design/Builder has entered into the Agreement and for whom the Work is to be performed.

29. *Owner's Consultant* – An individual or entity with whom the Owner may contract to furnish services to Owner with respect to the Project and who is identified as such in the Supplementary Conditions.

30. *Partial Utilization* – Use by Owner of a substantially completed part of the Work for the purpose for which it is intended (or a related purpose) prior to Substantial Completion of all the Work.

31. *PCBs* – Polychlorinated biphenyls.

32. *Petroleum* – Petroleum, including crude oil or any fraction thereof which is liquid at standard conditions of temperature and pressure (60 degrees Fahrenheit and 14.7 pounds per square inch absolute), such as oil, petroleum, fuel oil, oil sludge, oil refuse, gasoline, kerosene, and oil mixed with other non-Hazardous Wastes and crude oils.

33. *Project* – The total construction of which the Work to be provided under the Contract Documents may be the whole, or a part as indicated elsewhere in the Contract Documents.

34. *Proposal* – The documents submitted by Design/Builder in response to the Request for Proposals setting forth the design concepts, proposed prices, and other conditions for the Work to be performed.

35. *Radioactive Material* – Source, special nuclear, or byproduct material as defined by the Atomic Energy Act of 1954 (42 USC Section 2011 et seq.) as amended from time to time.

36. *Request for Proposals* – The document prepared by or for Owner specifying and describing Owner's objectives and the procedure to be followed in preparing and submitting a Proposal and awarding a contract.

37. *Resident Project Representative* – The authorized representative of Owner who may be assigned to the Site or any part thereof.

38. *Schedule of Values* – A schedule prepared by Design/Builder and acceptable to Owner indicating that portion of the Contract Price to be paid for each major component of the Work.

39. *Site* – Lands or other areas designated in the Contract Documents as being furnished by Owner upon which Construction is to be performed, including rights-of-way and easements for access thereto, and such other lands furnished by Owner which are designated for use of Design/Builder.

40. *Specifications* – The part of the Contract Documents prepared by or for Design/Builder and approved by Owner consisting of written technical descriptions of materials, equipment, construction systems, standards and workmanship as applied to the Work and certain administrative details applicable thereto.

41. *Subcontractor* – An individual or entity other than a Supplier having a direct contract with Design/Builder or with any other Subcontractor for the performance of a part of the Work.

42. *Submittal* – A written or graphic document prepared by or for Design/Builder which is required by the Contract Documents to be submitted to Owner by Design/Builder. Submittals may include Drawings, Specifications, progress schedules, shop drawings, samples, cash flow projections, and Schedules of Values. Submittals other than Drawings and Specifications are not Contract Documents.

43. *Substantial Completion* – The time at which the Work (or a specified part) has progressed to the point where it is sufficiently complete, in accordance with the Contract Documents, so that the Work (or a specified part) can be utilized for the purposes for which it is intended. The terms "substantially complete" and "substantially completed" as applied to all or part of the Work refer to Substantial Completion thereof.

44. *Supplementary Conditions* – The part of the Contract Documents which amends or supplements these General Conditions.

45. *Supplier* – A manufacturer, fabricator, supplier, distributor, materialman or vendor having a direct contract with Design/Builder or with any Subcontractor to furnish materials or equipment to be incorporated in the Work by Design/Builder or any Subcontractor.

46. *Unit Price Work* – Work to be paid for on the basis of unit prices.

47. *Work* – The entire construction or the various separately identifiable parts thereof required to be performed or furnished under the Contract Documents. Work includes and is the result of performing or furnishing Design Professional Services and Construction required by the Contract Documents.

48. *Work Change Directive* – A written directive to Design/Builder, issued on or after the Effective Date of the Agreement and signed by Owner ordering an addition, deletion or revision in the Work, or responding to differing site conditions under which the Work is to be performed or to emergencies. A Work Change Directive will not change the Contract Price or the Contract Times, but is evidence that the parties expect that the change directed or documented by a Work Change Directive will be incorporated in a subsequently issued Change Order following negotiations by the parties as to its effect, if any, on the Contract Price or Contract Times.

1. The word "day" shall constitute a calendar day of 24 hours measured from midnight to the next midnight.

2. The word "defective," when modifying the word "Construction" refers to Construction that is unsatisfactory, faulty, or deficient in that it does not conform to the Contract Documents, or does not meet the requirements of any inspection, reference standard, test or approval referred to in the Contract Documents, or has been damaged prior to Owner's final payment (unless responsibility for the protection thereof has been assumed by Owner at Substantial Completion) provided that the defect was not caused by Owner.

3. The word "furnish," when used in connection with services, materials, or equipment, shall mean to supply and deliver said services, materials or equipment to the Site (or some other specified location) ready for use or installation and in usable or operable condition.

4. The word "install," when used in connection with services, materials, or equipment, shall mean to put into use or place in final position said services, materials or equipment or equipment complete and ready for intended use.

5. The words "perform" or "provide" when used in connection with services, materials, or equipment, shall mean to furnish and install said services, materials, or equipment complete and ready for intended use.

6. When "furnish," "install," "perform," or "provide" is not used in connection with services, materials, or equipment in a context clearly requiring an obligation of Design/Builder, "provide" is implied.

7. Unless stated otherwise in the Contract Documents, words or phrases which have a well-known technical or construction industry or trade meaning are used in the Contract Documents in accordance with that meaning.

## 1.02 Terminology

### A. Intent of Certain Terms or Adjectives:

## ARTICLE 2 – PRELIMINARY MATTERS

---

### 2.01 Delivery of Bonds

A. When Design/Builder delivers the executed Agreements to Owner, Design/Builder shall also deliver to Owner such Bonds as Design/Builder may be required to furnish in accordance with paragraph 5.01.A.

### 2.02 Commencement of Contract Times; Notice to Proceed

A. The Contract Times will commence to run on the thirtieth day after the Effective Date of the Agreement, or, if a Notice to Proceed is given, on the day indicated in the Notice to Proceed. A Notice to Proceed may be given at any time within thirty days after the Effective Date of the Agreement. Unless agreed to in writing by Owner and Design/Builder, the Contract Times will commence to run no later than the ninetieth day after the last day for receipt of the Proposal or the thirtieth day after the Effective Date of the Agreement, whichever date is earlier.

### 2.03 Starting the Work

A. Design/Builder shall start to perform the Work on the date when the Contract Times commence to run. No Work shall be done at the Site prior to the date on which the Contract Times commence to run.

### 2.04 Before Starting the Work

A. *Design/Builder's Review of Contract Documents:* Before undertaking each part of the Work, Design/Builder shall carefully study and compare those Contract Documents prepared by Owner and check and verify pertinent figures therein and all applicable field measurements. Design/Builder shall promptly report in writing to Owner any conflict, error, ambiguity, or discrepancy which Design/Builder may discover and shall obtain a written interpretation or clarification from Owner before proceeding with any Work affected thereby; however, Design/Builder shall not be liable to Owner for failure to report any conflict, error, ambiguity, or discrepancy in the Contract Documents unless Design/Builder knew or reasonably should have known thereof.

B. *Preliminary Schedules:* Within 10 days after commencement of the Contract Times (unless otherwise specified in the Contract Documents), Design/Builder shall submit the following to Owner for its timely review:

1. A preliminary progress schedule indicating the times (numbers of days or dates) for starting and completing the various stages of the Work, including any Milestones specified in the Contract Documents;

2. A preliminary schedule of Submittals which will list each required Submittal and the times for submitting, reviewing and processing each Submittal;

3. A preliminary Schedule of Values for all of the Work which will include quantities and prices of items which when added together equal the Contract Price and subdivides the Work into component parts in sufficient detail to serve as the basis for progress payments during performance of the Work. Such prices will include an appropriate amount of overhead and profit applicable to each item of Work; and

4. A preliminary cash flow projection estimating that portion of the Contract Price to be due during each month of performance.

C. *Evidence of Insurance:* Before any Work at the Site is started, Design/Builder and Owner shall each deliver to the other, certificates of insurance as required by paragraph 5.03 which Design/Builder and Owner respectively are required to purchase and maintain in accordance with Article 5.

### 2.05 Initial Conference

A. Within twenty days after the Contract Times start to run, Design/Builder will arrange a conference attended by Owner and Design/Builder and others as appropriate to establish a working understanding among the parties as to the Work and to discuss the design concepts, schedules referred to in paragraph 2.04.B, procedures for handling Submittals, processing Applications for Payment, maintaining required records, items required pursuant to paragraph 8.01.A.6 and other matters.

### 2.06 Initial Acceptance of Schedules

A. At least ten days before submission of the first Application for Payment (unless otherwise provided in the Contract Documents), Design/Builder will arrange a conference attended by Design/Builder, Owner and others as appropriate to review for acceptability the schedules submitted in accordance with paragraph 2.04.B. Design/Builder shall have an additional ten days to make corrections and adjustments and to complete and resubmit the schedules. No progress payment shall be made to Design/Builder until the acceptable schedules are submitted to Owner.

1. The progress schedule will be acceptable to Owner if it provides an orderly progression of the Work to completion within any specified Milestones and the Contract Times. Such acceptance will not impose on Owner responsibility for the progress schedule, for sequencing, scheduling or progress of the Work nor interfere with nor relieve Design/Builder from Design/Builder's full responsibility therefor.

2. Design/Builder's schedule of Submittals will be acceptable to Owner if it provides a workable

arrangement for reviewing and processing the required Submittals.

3. Design/Builder's Schedule of Values will be acceptable to Owner as to form and substance if it provides a reasonable allocation of the Contract Price to component parts of the work.

## **ARTICLE 3 – CONTRACT DOCUMENTS: INTENT, AMENDING, REUSE**

---

### **3.01 Intent**

A. The Contract Documents are complementary; what is called for by one is as binding as if called for by all.

B. It is the intent of the Contract Documents to describe a functionally complete Project (or part thereof) to be designed and constructed in accordance with the Contract Documents. Any labor, documentation, services, materials, or equipment that may reasonably be inferred from the Contract Documents or from prevailing custom or trade usage as being required to produce the intended result will be furnished and performed whether or not specifically called for at no additional cost to Owner.

### **3.02 Reference Standards**

A. Standards, Specifications, Codes, Laws or Regulations.

1. Reference to standards, specifications, manuals or codes of any technical society, organization or association, or to Laws or Regulations, whether such reference be specific or by implication, shall mean the standard, specification, manual, code, or Laws or Regulations in effect on the last day for receipt of Proposals except as may be otherwise specifically stated in the Contract Documents.

2. No provision of any such standard, specification, manual, code, or instruction of a Supplier shall be effective to change the duties and responsibilities of Owner, Design/Builder, or any of their subcontractors, consultants, agents, or employees from those set forth in the Contract Documents, nor shall it be effective to assign to Owner any duty or authority to supervise or direct the furnishing or performance of the Work or any duty or authority to undertake responsibility inconsistent with the provisions of the Contract Documents.

### **3.03 Resolving Discrepancies**

A. In the event of a discrepancy between the Conceptual Documents on the one hand and the Proposal or Drawings or Specifications on the other hand, the Conceptual

Documents will control except when Owner has approved a Submittal pursuant to paragraph 6.17.B.

B. Except as otherwise specifically stated in the Contract Documents, the provisions of the Contract Documents shall take precedence in resolving any conflict, error, ambiguity, or discrepancy between the provisions of the Contract Documents and:

1. The provisions of any such standard, specification, manual, code, or instruction (whether or not specifically incorporated by reference in the Contract Documents); or

2. The provisions of any such Laws or Regulations applicable to the performance of the Work (unless such an interpretation of the provisions of the Contract Documents would result in violation of such Law or Regulation).

### **3.04 Amending and Supplementing Contract Documents**

A. The Contract Documents may be amended to provide for additions, deletions, and revisions in the Work or to modify the terms and conditions thereof in one or more of the following ways:

1. Owner's approval of required Submittals (pursuant to paragraph 6.17.B);

2. A Work Change Directive;

3. A Change Order;

4. A Field Order.

### **3.05 Reuse of Documents**

A. All documents including Drawings and Specifications prepared or furnished by Design/Builder pursuant to this Agreement are for Design/Builder's own use, and Design/Builder shall retain an ownership and property interest therein whether or not the Project is completed. Owner may make and retain copies for information and reference in connection with the use and occupancy of the Project by Owner and others. However, such documents are not intended or represented to be suitable for reuse by Owner or others on extensions of the Project or on any other project. Any reuse or any continued use after any termination without written verification or adaptation by Design/Builder for the specific purpose intended will be at Owner's sole risk and without liability or legal exposure to Design/Builder and Owner shall indemnify and hold harmless Design/Builder and Subcontractors from all claims, damages, losses and expenses including attorneys' fees arising out of or resulting therefrom. Any such verification or adaptation will entitle Design/Builder to further compensation at rates to be agreed upon by Owner and Design/Builder.

### **3.06 Electronic Data**

A. Copies of data furnished by Owner to Design/Builder or Design/Builder to Owner that may be relied upon are limited to the printed copies (also known as hard copies). Files in electronic media format of text, data, graphics, or other types are furnished only for the convenience of the receiving party. Any conclusion or information obtained or derived from such electronic files will be at the user's sole risk. If there is a discrepancy between the electronic files and the hard copies, the hard copies govern.

B. Because data stored in electronic media format can deteriorate or be modified inadvertently or otherwise without authorization of the data's creator, the party receiving electronic files agrees that it will perform acceptance tests or procedures within 60 days, after which the receiving party shall be deemed to have accepted the data thus transferred. Any errors detected within the 60-day acceptance period will be corrected by the transferring party.

C. When transferring documents in electronic media format, the transferring party makes no representations as to long term compatibility, usability, or readability of documents resulting from the use of software application packages, operating systems, or computer hardware differing from those used by the data's creator.

## **ARTICLE 4 – AVAILABILITY OF LANDS; DIFFERING SITE CONDITIONS; REFERENCE POINTS; HAZARDOUS ENVIRONMENTAL CONDITIONS**

---

### **4.01 Availability of Lands**

A. Owner shall furnish the Site. Owner shall notify Design/Builder of any encumbrances or restrictions not of general application but specifically related to use of the Site which Design/Builder will have to comply in performing the Work. Unless otherwise provided in the Contract Documents, Owner will obtain in a timely manner and pay for easements for permanent structures or permanent changes in existing facilities. If Design/Builder and Owner are unable to agree on entitlement to or the amount or extent of any adjustments in the Contract Price or the Contract Times as a result of any delay in Owner's furnishing the Site, Design/Builder may make a Claim therefor as provided in Article 9.

B. Upon reasonable written request, Owner shall furnish Design/Builder with a current statement of record legal title and legal description of the lands upon which the Construction is to be performed and Owner's interest therein as necessary for giving notice of or filing a mechanic's lien against such lands in accordance with applicable Laws or Regulations.

C. Design/Builder shall provide for all additional lands and access thereto that may be required for temporary construction facilities or storage of materials and equipment.

### **4.02 Differing Site Conditions**

A. Design/Builder shall promptly, and before the conditions are disturbed, give a written notice to Owner of (i) subsurface or latent physical conditions at the Site which differ materially from those indicated in the Contract Documents, or (ii) unknown physical conditions at the Site, of an unusual nature, which differ materially from those ordinarily encountered and generally recognized as inhering in work of the character called for by the Contract Documents.

B. Owner will investigate the Site conditions promptly after receiving the notice. If the conditions do materially so differ and cause an increase or decrease in the Design/Builder's cost of, or the time required for, performing any part of the Work, whether or not changed as a result of the conditions, an equitable adjustment shall be made under this clause and the Contract Price or Times modified in writing by Change Order in accordance with Article 9.

C. No request by Design/Builder for an equitable adjustment under paragraph 4.02 shall be allowed unless Design/Builder has given the written notice required; provided that the time prescribed in 9.03.A for giving written notice may be extended by Owner.

D. The provisions of this paragraph 4.02 are not intended to apply to a Hazardous Environmental Condition uncovered or revealed at the Site.

### **4.03 Reference Points**

A. Design/Builder shall be responsible for laying out the Work and shall protect and preserve the reference points and property monuments established by Owner pursuant to paragraph 8.01.A.6.e, and shall make no changes or relocations without the prior written approval of Owner. Design/Builder shall report to Owner whenever any reference point or property monument is lost or destroyed or requires relocation because of necessary changes in grades or locations, and shall be responsible for the accurate replacement or relocation of such reference points or property monuments by professionally qualified personnel.

### **4.04 Hazardous Environmental Condition at Site**

A. Design/Builder will not be responsible for any Hazardous Environmental Condition encountered at the Site which was not identified in the Contract Documents to be within the scope of the Work. Design/Builder shall be responsible for materials creating a Hazardous Environmental Condition created by any materials brought to the Site by Design/Builder, Subcontractors, Suppliers or anyone else for whom Design/Builder is responsible.



B. If Design/Builder encounters a Hazardous Environmental Condition, Design/Builder shall immediately: (i) secure or otherwise isolate such condition; (ii) stop all Construction in connection with such condition and in any area affected thereby (except in an emergency as required by paragraph 6.16); and (iii) notify Owner (and thereafter confirm such notice in writing). Owner shall promptly determine the necessity of retaining a qualified expert to evaluate such condition or take corrective action, if any.

C. Design/Builder shall not be required to resume Construction in connection with such Hazardous Environmental Condition or in any such affected area until after Owner has obtained any required permits related thereto and delivered to Design/Builder written notice (i) specifying that such condition and any affected area is or has been rendered safe for the resumption of Construction, or (ii) specifying any special conditions under which such Construction may be resumed safely. If Owner and Design/Builder cannot agree as to entitlement to or the amount or extent of an adjustment, if any, in Contract Price or Contract Times as a result of such Construction stoppage or such special conditions under which Construction is agreed to be resumed by Design/Builder, either party may make a Claim therefor as provided in Article 9.

D. If after receipt of such special written notice Design/Builder does not agree to resume Construction based on a reasonable belief it is unsafe, or does not agree to resume such Construction under such special conditions, then Owner may order such portion of the Work that is related to such Hazardous Environmental Condition to be deleted from the Work. If Owner and Design/Builder cannot agree as to entitlement to or the amount or extent of an adjustment, if any, in Contract Price or Contract Times as a result of deleting such portion of the Work, then either party may make a Claim therefor as provided in Article 9. Owner may have such deleted portion of the Work performed by Owner's own forces or others in accordance with Article 7.

E. To the fullest extent permitted by Laws or Regulations, Owner shall indemnify and hold harmless Design/Builder, Subcontractors, Suppliers and the officers, directors, partners, employees, agents, other consultants and subcontractors of each and any of them from and against all claims, costs, losses and damages (including but not limited to all fees and charges of engineers, architects, attorneys and other professionals and all court or arbitration or other dispute resolution costs) arising out of or resulting from such Hazardous Environmental Condition, provided that such Hazardous Environmental Condition: (i) was not shown or indicated in the Contract Documents to be included in the scope of the Work, and (iii) was not created by Design/Builder or by anyone for whom Design/Builder is responsible. Nothing in this paragraph 4.04.E shall obligate Owner to indemnify any individual or entity from and against the consequences of that individual's or entity's own negligence.

F. To the fullest extent permitted by Laws or Regulations, Design/Builder shall indemnify and hold harmless Owner, Owner's Consultant and the officers, directors, partners, employees, agents, other consultants and subcontractors of each and any of them from and against all claims, costs, losses and damages (including but not limited to all fees and charges of engineers, architects, attorneys and other professionals and all court or arbitration or other dispute resolution costs) arising out of or resulting from such Hazardous Environmental Condition created by Design/Builder or anyone for whom Design/Builder is responsible. Nothing in this paragraph 4.04.F shall obligate Design/Builder to indemnify any individual or entity from and against the consequences of that individual's or entity's own negligence.

---

## ARTICLE 5 – BONDS AND INSURANCE

### 5.01 Performance, Payment and Other Bonds

A. Design/Builder shall furnish performance and payment Bonds, each in an amount at least equal to the Contract Price as security for the faithful performance and payment of all Design/Builder's obligations to furnish, provide and pay for Work and related materials under the Contract Documents. These Bonds shall remain in effect at least until one year after the date when final payment becomes due, except as provided otherwise by Laws or Regulations or by the Contract Documents. Design/Builder shall also furnish such other Bonds as are required by the Contract Documents.

B. All Bonds shall be in the form prescribed by the Contract Documents except as provided otherwise by Laws or Regulations, and shall be executed by such sureties as are named in the current list of "Companies Holding Certificates of Authority as Acceptable Sureties on Federal Bonds and as Acceptable Reinsuring Companies" as published in Circular 570 by the Audit Staff, Bureau of Government Financial Operations, U.S. Department of the Treasury. All Bonds signed by an agent must be accompanied by a certified copy of such agent's authority to act.

C. If the surety on any Bond furnished by Design/Builder is declared a bankrupt or becomes insolvent or its right to do business is terminated in any state where any part of the Project is located or it ceases to meet the requirements of paragraph 5.01.B and 5.02, Design/Builder shall within twenty days thereafter substitute another Bond and surety, both of which shall comply with the requirements of paragraphs 5.01.B and 5.02.

### 5.02 Licensed Sureties and Insurers

A. All Bonds and insurance required by the Contract Documents to be purchased and maintained by Owner or Design/Builder shall be obtained from surety or insurance companies that are duly licensed or authorized in the

jurisdiction in which the Project is located to issue Bonds or insurance policies for the limits and coverages so required. Such surety and insurance companies shall also meet such additional requirements and qualifications as may be provided in the Supplementary Conditions.

### 5.03 Certificates of Insurance

A. Design/Builder shall deliver to Owner, with copies to each additional insured indicated in the Supplementary Conditions, certificates of insurance (and other evidence of insurance requested by Owner or any other additional insured) which Design/Builder is required to purchase and maintain. Owner shall deliver to Design/Builder, with copies to each additional insured indicated in the Supplementary Conditions, certificates of insurance (and other evidence of insurance requested by Design/Builder or any other additional insured) which Owner is required to purchase and maintain.

### 5.04 Design/Builder's Liability Insurance

A. Design/Builder shall purchase and maintain such liability and other insurance as is appropriate for the Work being performed and as will provide protection from claims set forth below which may arise out of or result from Design/Builder's performance of the Work and Design/Builder's other obligations under the Contract Documents, whether it is to be performed by Design/Builder, any Subcontractor or Supplier or by anyone directly or indirectly employed by any of them to perform any of the Work, or by anyone for whose acts any of them may be liable:

1. Claims under workers' compensation, disability benefits and other similar employee benefit acts;
2. Claims for damages because of bodily injury, occupational sickness or disease, or death of Design/Builder's employees;
3. Claims for damages because of bodily injury, sickness or disease, or death of any person other than Design/Builder's employees;
4. Claims for damages insured by reasonably available personal injury liability coverage which are sustained (i) by any person as a result of an offense directly or indirectly related to the employment of such person by Design/Builder, or (ii) by any other person for any other reason;
5. Claims for damages, other than to the Work itself, because of injury to or destruction of tangible property wherever located, including loss of use resulting therefrom; and
6. Claims for damages because of bodily injury or death of any person or property damage arising out of the ownership, maintenance or use of any motor vehicle.

B. The policies of insurance required by paragraph 5.04.A shall:

1. With respect to insurance required by paragraphs 5.04.A.3 through 5.04.A.6 inclusive, (subject to any customary exclusion in respect of professional liability) include as additional insureds Owner and Owner's Consultants and any other persons or entities indicated in the Supplementary Conditions, all of whom shall be listed as additional insureds, and include coverage for the respective officers, directors, partners, and employees, agents, and other consultants and subcontractors of each and any of all such additional insureds, and the insurance afforded to these additional insureds shall provide primary coverage for all claims covered thereby;

2. Include at least the specific coverages and be written for not less than the limits of liability provided in the Supplementary Conditions or required by Laws or Regulations, whichever is greater;

3. Include completed operations insurance;

4. Include contractual liability insurance covering Design/Builder's indemnity obligations under paragraphs 6.11.A.3 and 6.21;

5. Contain a provision or endorsement that the coverage afforded will not be canceled, materially changed or renewal refused until at least thirty days' prior written notice has been given to Owner and each other additional insured indicated in the Supplementary Conditions to whom a certificate of insurance has been issued (and the certificates of insurance furnished by the Design/Builder pursuant to paragraph 5.03 will so provide);

6. Remain in effect at least until final payment and at all times thereafter when Design/Builder may be correcting, removing or replacing defective Construction in accordance with paragraphs 12.06 and 12.07; and

7. With respect to completed operations insurance, and any other insurance coverage written on a claims-made basis, remain in effect for at least two years after final payment (and Design/Builder shall furnish Owner and each other additional insured indicated in the Supplementary Conditions to whom a certificate of insurance has been issued evidence satisfactory to Owner and any such additional insured of continuation of such insurance at final payment and one year thereafter).

### 5.05 Owner's Liability Insurance

A. In addition to the insurance required to be provided by Design/Builder under paragraph 5.04, Owner, at Owner's option, may purchase and maintain at Owner's expense

Owner's own liability insurance as will protect Owner against claims which may arise from operations under the Contract Documents.

## 5.06 Property Insurance

A. Unless otherwise provided in the Supplementary Conditions, Owner shall purchase and maintain property insurance upon the Construction at the Site in the amount of the full replacement cost thereof (subject to such deductible amounts as may be provided in the Supplementary Conditions or required by Laws or Regulations). This insurance will:

1. Include the interests of Owner, Owner's Consultant, Design/Builder, Subcontractors, and any other individuals or entities indicated in the Supplementary Conditions, and the officers, directors, partners, employees, agents, and other consultants and subcontractors of each and any of them, each of whom is deemed to have an insurable interest and shall be listed as an insured or additional insured;

2. Be written on a Builder's Risk "all-risk" or open peril or special causes of loss policy form that shall at least include insurance for physical loss and damage to the Construction, temporary buildings, falsework and all materials and equipment in transit, and shall insure against at least the following perils or causes of loss: fire, lightning, extended coverage, theft, vandalism and malicious mischief, earthquake, collapse, debris removal, demolition occasioned by enforcement of Laws or Regulations, water damage, and such other perils or causes of loss as may be specifically required by the Supplementary Conditions;

3. Include expenses incurred in the repair or replacement of any insured property (including but not limited to fees and charges of engineers and architects);

4. Cover materials and equipment stored at the Site or at another location that was agreed to in writing by Owner prior to being incorporated in the Construction, provided that such materials and equipment have been included in an Application for Payment approved by Owner;

5. Allow partial utilization in accordance with paragraph 13.06;

6. Include testing and startup; and

7. Be maintained in effect until final payment is made unless otherwise agreed to in writing by Owner and Design/Builder with thirty days' written notice to each other additional insured to whom a certificate of insurance has been issued.

B. Owner shall purchase and maintain such boiler and machinery insurance or additional property insurance as may

be required by the Supplementary Conditions or Laws or Regulations which will include the interests of Owner, Owner's Consultants, Design/Builder, Subcontractors, and any other individuals or entities indicated in the Supplementary Conditions, each of whom is deemed to have an insurable interest and shall be listed as an insured or additional insured.

C. All the policies of insurance (and the certificates or other evidence thereof) required to be purchased and maintained by Owner in accordance with paragraph 5.06 will contain a provision or endorsement that the coverage afforded will not be canceled or materially changed or renewal refused until at least 30 days' prior written notice has been given to Design/Builder and to each other additional insured to whom a certificate of insurance has been issued and will contain waiver provisions in accordance with paragraph 5.07.

D. Owner shall not be responsible for purchasing and maintaining any property insurance to protect the interests of Design/Builder, Subcontractors, Suppliers, or others in the Work to the extent of any deductible amounts that are identified in the Supplementary Conditions. The risk of loss within such identified deductible amount, will be borne by Design/Builder, Subcontractor or others suffering any such loss and if any of them wishes property insurance coverage within the limits of such amounts, each may purchase and maintain it at the purchaser's own expense.

E. If Design/Builder requests in writing that other special insurance be included in the property insurance policies provided under paragraph 5.06, Owner shall, if possible, include such insurance, and the cost thereof will be charged to Design/Builder by appropriate Change Order. Prior to commencement of the Work at the Site, Owner shall in writing advise Design/Builder whether or not such other insurance has been procured by Owner.

## 5.07 Waiver of Rights

A. Owner and Design/Builder intend that all policies purchased in accordance with paragraph 5.06 will protect Owner, Owner's Consultant, Design/Builder, Subcontractors, Suppliers, and all other individuals or entities indicated in the Supplementary Conditions to be listed as insureds or additional insureds (and the officers, directors, partners, employees, agents, and other consultants and subcontractors of each and any of them) in such policies and will provide primary coverage for all losses and damages caused by the perils or causes of loss covered thereby. All such policies shall contain provisions to the effect that in the event of payment of any loss or damage the insurers will have no rights of recovery against any of the insureds or additional insureds thereunder. Owner and Design/Builder waive all rights against each other and their respective officers, directors, partners, employees, agents, and other consultants and subcontractors of each and any of them for all losses and damages caused by, arising out of or resulting from any of the perils or causes of loss covered by such policies and any other property insurance applicable to the Work; and, in addition,

waive all such rights against Owner's Consultant, Subcontractors, Suppliers, and all other individuals or entities indicated in the Supplementary Conditions to be listed as insureds or additional insureds under such policies for losses and damages so caused. None of the above waivers shall extend to the rights that any party making such waiver may have to the proceeds of insurance held by Owner as trustee or otherwise payable under any policy so issued.

B. Owner waives all rights against Design/Builder, Subcontractors, and Suppliers and the officers, directors, employees and agents of any of them for:

1. Loss due to business interruption, loss of use, or other consequential loss extending beyond direct physical loss or damage to Owner's property caused by, arising out of or resulting from fire or other peril whether or not insured by Owner; and

2. Loss or damage to the completed Project or any part thereof caused by, arising out of or resulting from fire or other insured peril or cause or loss covered by any property insurance maintained on the completed Project or part thereof by Owner during partial utilization pursuant to paragraph 13.06, after Substantial Completion pursuant to paragraph 13.05, or after final payment pursuant to paragraph 13.08.

C. Any insurance policy maintained by Owner covering any loss, damage or consequential loss referred to in paragraph 5.07.B shall contain provisions to the effect that in the event of payment of any such loss, damage, or consequential loss, the insurers will have no rights of recovery against Design/Builder, Subcontractors, Owner's Consultant, and the officers, directors, partners, employees, agents, and other consultants and subcontractors of each and any of them.

#### **5.08 Receipt and Application of Insurance Proceeds**

A. Any insured loss under the policies of insurance required by paragraph 5.06 will be adjusted with Owner and made payable to Owner as fiduciary for the insureds, as their interests may appear, subject to the requirements of any applicable mortgage clause and of paragraph 5.08.B. Owner shall deposit in a separate account any money so received, and shall distribute it in accordance with such agreement as the parties in interest may reach. If no other special agreement is reached the damaged Construction shall be repaired or replaced, the moneys so received applied on account thereof and the Work and the cost thereof covered by an appropriate Change Order.

B. Owner as fiduciary shall have power to adjust and settle any loss with the insurers unless one of the parties in interest shall object in writing within 15 days after the occurrence of loss to Owner's exercise of this power. If such objection be made, Owner as fiduciary shall make settlement with the insurers in accordance with such agreement as the parties in interest may reach. If no such agreement among the

parties in interest is reached, Owner as fiduciary shall adjust and settle the loss with the insurers and, if required in writing by any party in interest, Owner as fiduciary shall give bond for the proper performance of such duties.

#### **5.09 Acceptance of Bonds and Insurance; Option to Replace**

A. If either Owner or Design/Builder has any objection to the coverage afforded by or other provisions of the Bonds or insurance required to be purchased and maintained by the other party in accordance with Article 5 on the basis of their not complying with the Contract Documents, the objecting party shall so notify the other party in writing within ten days after receipt of the certificates (or other evidence requested) required by paragraph 2.04.C. Owner and Design/Builder shall each provide to the other such additional information in respect of insurance provided as the other may reasonably request. If either party does not purchase or maintain all of the Bonds and insurance required of such party by the Contract Documents, such party shall notify the other party in writing of such failure to purchase prior to the start of the Work, or of such failure to maintain prior to any change in the required coverage. Without prejudice to any other right or remedy, the other party may elect to obtain equivalent Bonds or insurance to protect such other party's interests at the expense of the party who was supposed to provide such coverage, and a Change Order shall be issued to adjust the Contract Price accordingly.

#### **5.10 Partial Utilization, Acknowledgment of Property Insurance**

A. If Owner finds it necessary to occupy or use a portion or portions of the Work prior to Substantial Completion of all the Work as provided in paragraph 13.06, no such use or occupancy shall commence before the insurers providing the property insurance pursuant to paragraph 5.06 have acknowledged notice thereof and in writing effected any changes in coverage necessitated thereby. The insurers providing the property insurance shall consent by endorsement on the policy or policies, but the property insurance shall not be canceled or permitted to lapse on account of any such partial use or occupancy.

### **ARTICLE 6 – DESIGN/BUILDER'S RESPONSIBILITIES**

---

#### **6.01 Design Professional Services**

A. *Standard of Care.* The standard of care for Design Professional Services performed or furnished under this Agreement will be the care and skill ordinarily used by members of the engineering profession practicing under similar conditions at the same time and locality.

B. *Preliminary Design Phase.* After the Contract Times commence to run, Design/Builder shall:

1. Consult with Owner to understand Owner's requirements for the Project and review available data;
2. Advise Owner as to the necessity of Owner's providing or obtaining from others additional reports, data, or services of the types provided in paragraph 8.01.A.6.a-g and assist Owner in obtaining such reports, data, or services;
3. Identify and analyze requirements of governmental authorities having jurisdiction to approve the portions of the Project designed or specified by Design/Builder with whom consultation is to be undertaken in connection with the Project;
4. Obtain such additional geotechnical and related information which it deems necessary for performance of the Work;
5. On the basis of the Conceptual Documents and Design/Builder's Proposal, prepare preliminary design documents consisting of final design criteria, preliminary drawings, outline specifications, and written descriptions of the Project;
6. Furnish the preliminary design documents to and review them with Owner within the times indicated in the schedules described in paragraphs 2.06.A.1 and 2.06.A.2; and
7. Identify any variations in the preliminary design documents from the Contract Documents in accordance with 6.17.B.

C. *Final Design Phase.* After written acceptance by Owner of the preliminary design phase documents Design/Builder shall:

1. On the basis of the accepted Preliminary Design Phase documents, prepare final Drawings showing the scope, extent, and character of the Construction to be performed and furnished by Design/Builder and Specifications (which will be prepared, where appropriate, in general conformance with the sixteen division format of the Construction Specifications Institute);
2. Provide technical criteria, written descriptions and design data required for obtaining approvals of such governmental authorities as have jurisdiction to review or approve the final design of the Project, and assist Owner in consultations with appropriate authorities;
3. Furnish the above documents, Drawings, and Specifications to and review them with Owner within the

times indicated in the schedules described in paragraphs 2.06.A.1 and 2.06.A.2; and

4. Identify any deviations from other Contract Documents in accordance with paragraph 6.17.B.

## **6.02 Supervision and Superintendence of Construction**

A. Design/Builder shall supervise, inspect and direct the Construction competently and efficiently, devoting such attention thereto and applying such skills and expertise as may be necessary to provide the Construction in accordance with the Contract Documents. Design/Builder shall be solely responsible for the means, methods, techniques, sequences and procedures of Construction. Design/Builder shall be responsible to see that the completed Construction complies accurately with the Contract Documents and shall keep Owner advised as to the quality and progress of the Construction.

B. At all times during the progress of Construction, the Design/Builder shall assign a competent resident superintendent thereto, who shall not be replaced without written notice to Owner except under extraordinary circumstances. The superintendent will be Design/Builder's representative at the Site and shall have authority to act on behalf of Design/Builder. All communications given to or received from the superintendent shall be binding on Design/Builder.

## **6.03 Labor, Working Hours**

A. Design/Builder shall provide competent, suitably qualified personnel to perform the Work as required by the Contract Documents. Design/Builder shall at all times maintain good discipline and order at the Site.

B. Except as otherwise required for the safety or protection of persons or the Work or property at the Site or adjacent thereto, and except as otherwise indicated in the Contract Documents, all Construction at the Site shall be performed during regular working hours, and Design/Builder will not permit overtime work or the performance of Construction on Saturday, Sunday or any legal holiday without Owner's written consent, which will not be unreasonably withheld.

## **6.04 Services, Materials, and Equipment**

A. Unless otherwise specified in the Contract Documents, Design/Builder shall furnish or cause to be furnished and assume full responsibility for materials, equipment, labor, transportation, construction equipment and machinery, tools, appliances, fuel, power, light, heat, telephone, water, sanitary facilities, temporary facilities, and all other facilities and incidentals necessary for the Work.

B. All materials and equipment incorporated into the Work shall be of good quality and new, except as otherwise provided in the Contract Documents. All warranties and

guarantees specifically called for by the Contract Documents shall expressly run to the benefit of Owner. If reasonably required by Owner, Design/Builder shall furnish satisfactory evidence (including reports of required tests) as to the source, kind, and quality of materials and equipment. All materials and equipment shall be applied, installed, connected, erected, used, cleaned, and conditioned in accordance with instructions of the applicable Supplier, except as otherwise provided in the Contract Documents.

#### **6.05 Progress Schedule**

A. Design/Builder shall adhere to the progress schedule established in accordance with paragraph 2.06.A as it may be adjusted from time to time as provided below:

1. Design/Builder shall submit to Owner for acceptance proposed adjustments in the progress schedule that will not change the Contract Times (or Milestones). Such adjustments will conform generally to the progress schedule then in effect.

2. Proposed adjustments in the progress schedule that will change the Contract Times (or Milestones) shall be submitted in accordance with the requirements of Article 11.02. Such adjustments may only be made by a Change Order or .

#### **6.06 Concerning Subcontractors, Suppliers, and Others**

A. Design/Builder shall not employ any Subcontractor, Supplier, or other individual or entity against whom Owner may have reasonable objection. Design/Builder shall not be required to employ any Subcontractor, Supplier or other individual or entity to furnish or perform any of the Work against whom Design/Builder has reasonable objection.

B. Design/Builder shall be fully responsible to Owner for all acts and omissions of the Subcontractors, Suppliers and other individuals or entities performing or furnishing any of the Work just as Design/Builder is responsible for Design/Builder's own acts and omissions. Nothing in the Contract Documents shall create for the benefit of any such Subcontractor, Supplier, or other individual or entity any contractual relationship between Owner and any such Subcontractor, Supplier, or other individual or entity, nor shall it create any obligation on the part of Owner to pay or to see to the payment of any moneys due any such Subcontractor, Supplier, or other individual or entity except as may otherwise be required by Laws or Regulations.

C. Design/Builder shall be solely responsible for scheduling and coordinating Subcontractors, Suppliers and other individuals and entities performing or furnishing any of the Work under a direct or indirect contract with Design/Builder.

D. Design/Builder shall require all Subcontractors, Suppliers and such other individuals and entities performing

or furnishing any of the Work to communicate with the Owner through Design/Builder.

E. All Work performed for Design/Builder by a Subcontractor or Supplier will be pursuant to an appropriate Design Subagreement or Construction Subagreement between Design/Builder and the Subcontractor or Supplier which specifically binds the Subcontractor or Supplier to the applicable terms and conditions of the Contract Documents for the benefit of Owner. Whenever any such agreement is with a Subcontractor or Supplier who is listed as an additional insured on the property insurance provided in paragraph 5.06, the agreement between the Design/Builder and the Subcontractor or Supplier will contain provisions whereby the Subcontractor or Supplier waives all rights against Owner, Design/Builder, Owner's Consultant, and all other additional insureds (and their officers, directors, partners, employees, agents, and other consultants and subcontractors of each and any of them) for all losses and damages caused by any of the perils or causes of loss covered by such policies and any other property insurance applicable to the Work. If the insurers on any such policies require separate waiver forms to be signed by any Subcontractor or Supplier, Design/Builder will obtain the same.

#### **6.07 Patent Fees and Royalties**

A. Design/Builder shall pay all license fees and royalties and assume all costs incident to the use in the performance of the Work or the incorporation in the Work of any invention, design, process, product or device which is the subject of patent rights or copyrights held by others. If a particular invention, design, process, product, or device is specified in the Conceptual Documents for use in the performance of the Construction and if to the actual knowledge of Owner its use is subject to patent rights or copyrights calling for the payment of any license fee or royalty to others, the existence of such rights shall be disclosed by Owner in the Conceptual Documents.

B. To the fullest extent permitted by Laws or Regulations, Design/Builder shall indemnify and hold harmless Owner and Owner's Consultant, and the officers, directors, partners, employees or agents, and other consultants of each and any of them from and against all claims, costs, losses and damages (including but not limited to all fees and charges of engineers, architects, attorneys and other professionals and all court or arbitration or other dispute resolution costs) arising out of or resulting from any infringement of patent rights or copyrights incident to the use in the performance of the Work or resulting from the incorporation in the Work of any invention, design, process, product or device not identified in the Conceptual Documents.

C. To the fullest extent permitted by Laws or Regulations, Owner shall indemnify and hold harmless Design/Builder and its officers, directors, partners, employees or agents, Subcontractors and Suppliers from and against all claims, costs, losses and damages (including but not limited to

all fees and charges of engineers, architects, attorneys and other professionals and all court or arbitration or other dispute resolution costs) arising out of or resulting from any infringement of patent rights or copyrights incident to the use in the performance of the Work or resulting from the incorporation in the Work of any invention, design, process, product or device required by the Conceptual Documents.

#### **6.08 Permits**

A. Unless otherwise provided in the Contract Documents, Design/Builder shall obtain and pay for all necessary permits, licenses, and approvals of governmental authorities having jurisdiction over the Work. Owner shall assist Design/Builder, when necessary, in obtaining such permits, licenses and approvals. Design/Builder shall pay all governmental charges and inspection fees necessary for the performance of the Work, which are applicable on the last day for receipt of Proposals. Design/Builder shall pay all charges of utility owners for connections to the Work, and Owner shall pay all charges of such utility owners for capital costs related thereto.

#### **6.09 Laws or Regulations**

A. Design/Builder shall give all notices required by and comply with all Laws or Regulations applicable to the performance of the Work. Except where otherwise expressly required by applicable Laws and Regulations, Owner shall not be responsible for monitoring Design/Builder's compliance with any Laws or Regulations.

B. If Design/Builder performs any Work knowing or having reason to know that it is contrary to Laws or Regulations, Design/Builder shall bear all costs arising therefrom.

C. Changes in Laws or Regulations not known on the date of receipt of Proposals having an effect on the cost or time of performance may be the subject of a change in Contract Price or Contract Times.

#### **6.10 Taxes**

A. Design/Builder shall pay all sales, consumer, use, and other similar taxes required to be paid by Design/Builder in accordance with the Laws or Regulations of the place of the Project which are applicable during the performance of the Work.

#### **6.11 Use of Site and Other Areas**

A. Limitation on Use of Site and Other Areas.

1. Design/Builder shall confine construction equipment, the storage of materials and equipment, and the operations of construction workers to the Site and other areas permitted by Laws or Regulations, and shall not unreasonably encumber the Site and other areas with

construction equipment or other materials or equipment. Design/Builder shall assume full responsibility for any damage to any such land or area, or to the owner or occupant thereof or of any adjacent land or areas, resulting from the performance of the Work.

2. Should any claim be made by any such owner or occupant because of the performance of Work, Design/Builder shall promptly settle with such other party by negotiation or otherwise resolve the claim by arbitration or other dispute resolution proceeding or at law.

3. To the fullest extent permitted by Laws or Regulations, Design/Builder shall indemnify and hold harmless Owner, Owner's Consultants and anyone directly or indirectly employed by any of them from and against all claims, costs, losses and damages (including, but not limited to, fees of engineers, architects, attorneys and other professionals and court and arbitration or other dispute resolution costs) arising out of or resulting from any claim brought by any such owner or occupant against Owner, or any other party indemnified hereunder to the extent caused by or based upon Design/Builder's performance of the Construction.

B. *Removal of Debris.* During the performance of the Construction, Design/Builder shall keep the premises free from accumulations of waste materials, rubbish, and other debris resulting from the Construction. Removal and disposal of such waste materials, rubbish, and other debris shall conform to applicable Laws or Regulations.

C. *Cleaning.* Prior to Substantial Completion, Design/Builder shall clean the Site and make it ready for utilization by Owner. At completion of Construction, Design/Builder shall remove all tools, appliances, construction equipment, temporary construction and machinery, and surplus materials and shall restore to original condition all property not designated for alteration by the Contract Documents.

D. *Loading Structures.* Design/Builder shall not load nor permit any part of any structure to be loaded in any manner that will endanger the structure, nor shall Design/Builder subject any part of the Construction or adjacent property to stresses or pressures that will endanger it.

#### **6.12 Record Documents**

A. Design/Builder shall maintain in a safe place at the Site one record copy of all Drawings, Specifications, Addenda, Change Orders, Field Orders and Work Change Directives in good order and annotated to show all changes made during performance of the Work. These record documents together with all approved Submittals will be available to Owner for reference. Upon completion of the Work, these record documents and Submittals, including a

reproducible set of record drawings, will be delivered to Owner.

### **6.13 Safety and Protection**

A. Design/Builder shall be solely responsible for initiating, maintaining and supervising all safety precautions and programs in connection with the Work. Design/Builder shall take all necessary precautions for the safety of, and shall provide the necessary protection to prevent damage, injury, or loss to:

1. All persons on the Site or who may be affected by the Work;
2. All Work and materials and equipment to be incorporated therein, whether in storage on or off the Site; and
3. Other property at the Site or adjacent thereto, including trees, shrubs, lawns, walks, pavements, roadways, structures, utilities and underground facilities not designated for removal, relocation, or replacement in the course of construction.

B. Design/Builder shall comply with applicable Laws or Regulations relating to the safety of persons or property, or to the protection of persons or property from damage, injury, or loss; and shall erect and maintain all necessary safeguards for such safety and protection. Design/Builder shall notify owners of adjacent property and of underground facilities and utility owners when prosecution of the Work may affect them, and shall cooperate with them in the protection, removal, relocation, and replacement of their property.

C. All damage, injury, or loss to any property referred to in paragraph 6.13.A.2 or 6.13.A.3 caused, directly or indirectly, in whole or in part, by Design/Builder, any Subcontractor, Supplier, or any other individual or entity directly or indirectly employed by any of them to perform any of the Work, or anyone for whose acts any of them may be liable, shall be remedied by Design/Builder.

D. Design/Builder's duties and responsibilities for safety and for protection of the construction shall continue until such time as all the Work is completed and Owner has issued a notice to Design/Builder in accordance with paragraph 13.08.B that the Work is acceptable (except as otherwise expressly provided in connection with Substantial Completion).

### **6.14 Safety Representative**

A. Design/Builder shall designate a qualified and experienced safety representative at the Site whose duties and responsibilities shall be the prevention of accidents and the maintaining and supervising of safety precautions and programs.

### **6.15 Hazard Communication Programs**

A. Design/Builder shall be responsible for coordinating any exchange of material safety data sheets or other hazard communication information required to be made available to or exchanged between or among employers at the Site in accordance with Laws or Regulations.

### **6.16 Emergencies**

A. In emergencies affecting the safety or protection of persons or the Work or property at the Site or adjacent thereto, Design/Builder is obligated to act to prevent threatened damage, injury or loss. Design/Builder shall give Owner prompt written notice if Design/Builder believes that any significant changes in the Work or variations from the Contract Documents have been caused thereby or are required as a result thereof. If a change in the Contract Documents is required because of the action taken by Design/Builder in response to such an emergency, a Work Change Directive or Change Order will be issued.

### **6.17 Submittals**

A. Owner will review and approve Submittals in accordance with the schedule of required Submittals accepted by Owner as required by paragraph 2.06.A. Owner's review and approval will be only to determine if the items covered by the Submittals will, after installation or incorporation in the construction, conform to the information given in the Contract Documents and be compatible with the design concept of the completed Project as a functioning whole as indicated by the Contract Documents. Owner's review and approval will not extend to means, methods, techniques, sequences, or procedures of construction (except where a particular means, method, technique, sequence, or procedure of construction is specifically and expressly called for by the Contract Documents) or to safety precautions or programs incident thereto. The review and approval of a separate item as such will not indicate approval of the assembly in which the item functions.

B. Owner's review and approval of Submittals shall not relieve Design/Builder from responsibility for any variation from the requirements of the Contract Documents unless Design/Builder has in a separate written communication at the time of submission called Owner's attention to each such variation and Owner has given written approval.

C. Construction prior to Owner's review and approval of any required Submittal will be at the sole risk of Design/Builder.

### **6.18 Continuing the Work**

A. Design/Builder shall continue the Work and adhere to the progress schedule during all disputes or disagreements with Owner. No Work shall be delayed or postponed pending



resolution of any disputes or disagreements, except as Design/Builder and Owner may otherwise agree in writing.

### 6.19 Post-Construction Phase

A. Design/Builder shall:

1. Provide assistance in connection with the start-up, testing, refining and adjusting of any equipment or system.
2. Assist Owner in training staff to operate and maintain the Work.
3. Assist Owner in developing systems and procedures for control of the operation and maintenance of and record keeping for the Work.

### 6.20 Design/Builder's General Warranty and Guarantee

A. Design/Builder warrants and guarantees to Owner that all Construction will be in accordance with the Contract Documents and will not be defective. Design/Builder's warranty and guarantee hereunder excludes defects or damage caused by:

1. Abuse, modification or improper maintenance or operation by persons other than Design/Builder, Subcontractors, or Suppliers or any other individual for whom Design/Builder is responsible; or
2. Normal wear and tear under normal usage.

B. Design/Builder's obligation to perform and complete the Work in accordance with the Contract Documents shall be absolute. None of the following will constitute an acceptance of Work that is not in accordance with the Contract Documents or a release of Design/Builder's obligation to perform the Work in accordance with the Contract Documents:

1. Observations by Owner;
2. The making of any progress or final payment;
3. The issuance of a certificate of Substantial Completion;
4. Use or occupancy of the Work or any part thereof by Owner;
5. Any acceptance by Owner or any failure to do so;
6. Any review and approval of a Submittal;
7. Any inspection, test or approval by others; or

8. Any correction of defective Construction by Owner.

### 6.21 Indemnification

A. To the fullest extent permitted by Laws or Regulations, Design/Builder shall indemnify and hold harmless Owner, Owner's Consultants, and the officers, directors, partners, employees, agents, other consultants and subcontractors of each from and against all claims, costs, losses, and damages (including but not limited to all fees and charges of engineers, architects, attorneys and other professionals and all court or arbitration or other dispute resolution costs) arising out of or resulting from the performance of Construction, provided that any such claim, cost, loss, or damage is attributable to bodily injury, sickness, disease, or death, or to injury to or destruction of tangible property (other than the Work itself), including the loss of use resulting therefrom) but only to the extent caused by any negligent act or omission of Design/Builder, any Subcontractor, any Supplier, or any individual or entity directly or indirectly employed by any of them to perform or furnish any of the Work.

B. In any and all claims against Owner, Owner's Consultant or any of their respective consultants, agents, officers, directors, partners or employees by any employee (or the survivor or personal representative of such employee) of Design/Builder, any Subcontractor, any Supplier, any individual or entity directly or indirectly employed by any of them to perform any of the Work or anyone for whose acts any of them may be liable, the indemnification obligation under paragraph 6.21.A shall not be limited in any way by any limitation on the amount or type of damages, compensation or benefits payable by or for Design/Builder or any such Subcontractor, Supplier, or other individual or entity under workers' compensation acts, disability benefit acts or other employee benefit acts.

C. The indemnification obligations of Design/Builder under paragraph 6.21.A shall not extend to the liability of Owner's Consultant, and their officers, directors, partners, employees, agents, other consultants, and subcontractors arising out of the preparation or approval of maps, drawings, opinions, reports, surveys, designs, or specifications.

## ARTICLE 7 – OTHER CONSTRUCTION

---

### 7.01 Related Work at Site

A. Owner may perform other Work related to the Project at the Site by Owner's employees, or let other direct contracts therefor, or have other work performed by utility owners. If such other work is not noted in the Contract Documents, then:

1. Written notice thereof will be given to Design/Builder prior to starting any such other work; and

2. Design/Builder may make a Claim therefor as provided in Article 9 if Design/Builder believes that such performance will involve additional expense to Design/Builder or requires additional time and the parties are unable to agree as to the amount or extent thereof.

B. Design/Builder shall afford each other contractor who is a party to such a direct contract and each utility owner (and Owner, if Owner is performing the additional work with Owner's employees) proper and safe access to the Site and a reasonable opportunity for the introduction and storage of materials and equipment and the execution of such other work and shall properly connect and coordinate the Work with theirs. Unless otherwise provided in the Contract Documents, Design/Builder shall do all cutting, fitting, and patching of the Work that may be required to make its several parts come together properly and integrate with such other work. Design/Builder shall not endanger any work of others by cutting, excavating, or otherwise altering their work and will only cut or alter their work with the written consent of Owner and the others whose work will be affected. The duties and responsibilities of Design/Builder under this paragraph are for the benefit of such utility owners and other contractors to the extent that there are comparable provisions for the benefit of Design/Builder in said direct contracts between Owner and such utility owners and other contractors.

C. If the proper execution or results of any part of Design/Builder's Work depends upon work performed or services provided by others under this Article 7, Design/Builder shall inspect such other work and appropriate instruments of service and promptly report to Owner in writing any delays, defects or deficiencies in such other work or services that render it unavailable or unsuitable for the proper execution and results of Design/Builder's Work. Design/Builder's failure so to report will constitute an acceptance of such other work as fit and proper for integration with Design/Builder's Work except for latent or nonapparent defects and deficiencies in such other work.

## 7.02 Coordination

A. If Owner intends to contract with others for the performance of other work on the Project at the Site, the following will be set forth in Supplementary Conditions:

1. The individual or entity who will have authority and responsibility for coordination of the activities among the various prime contractors will be identified;

2. The specific matters to be covered by such authority and responsibility will be itemized; and

3. The extent of such authority and responsibilities will be provided.

B. Unless otherwise provided in the Supplementary Conditions, Owner shall have sole authority and responsibility in respect of such coordination.

## ARTICLE 8 – OWNER'S RESPONSIBILITIES

---

### 8.01 General

A. Owner shall do the following in a timely manner so as not to delay the services of Design/Builder:

1. Designate in writing a person to act as Owner's Representative with respect to the services to be rendered under this Agreement. Such person shall have complete authority to transmit instructions, receive information, interpret and define Owner's policies, make decisions with respect to performance of the Work, and shall provide such other services as may be agreed upon;

2. Provide such legal services as Owner may require with regard to legal issues pertaining to the Project including any that may be raised by Design/Builder;

3. If requested in writing by Design/Builder, furnish reasonable evidence satisfactory to Design/Builder that sufficient funds are available and committed for the entire cost of the Project. Unless such reasonable evidence is furnished, Design/Builder is not required to commence or continue any Work, or may, if such evidence is not presented within a reasonable time, stop Work upon 15 days notice to the Owner;

4. Make payments to Design/Builder promptly when they are due as provided in paragraph 13.03 and 13.08;

5. Furnish the Site as set forth in paragraph 4.01.A;

6. Furnish to Design/Builder, as required for performance of Design/Builder's Services the following, all of which Design/Builder may use and rely upon in performing services under this Agreement:

a. Environmental assessment and impact statements;

b. Property, boundary, easement, right-of-way, topographic, and utility surveys;

c. Property descriptions;

d. Zoning, deed, and other land use restrictions;

e. Engineering surveys to establish reference points for design and construction which in Owner's judgment are necessary to enable Design/Builder to proceed with the Work;

f. Assistance to Design/Builder in filing documents required to obtain necessary permits, licenses, and approvals of governmental authorities having jurisdiction over the Project;

g. Permits, licenses, and approvals of government authorities Owner is specifically required to obtain by the Contract Documents; and

h. All subsurface data at or contiguous to the Site which Owner may have obtained.

7. Review Submittals subject to Owner review pursuant to paragraph 6.17.A; and

8. Provide information known to or in the possession of Owner relating to the presence of materials and substances at the Site which could create a Hazardous Environmental Condition.

## **8.02 Insurance**

A. Owner's responsibilities in respect of purchasing and maintaining liability and property insurance are set forth in Article 5.

## **8.03 Limitations on Owner's Responsibilities**

A. The Owner shall not supervise, direct, or have control or authority over, nor be responsible for, Design/Builder's means, methods, techniques, sequences, or procedures of construction or the safety precautions and programs incident thereto, or for any failure of Design/Builder to comply with Laws or Regulations applicable to the furnishing or performance of the Work. Owner will not be responsible for Design/Builder's failure to perform the Work in accordance with the Contract Documents.

## **8.04 Undisclosed Hazardous Environmental Condition**

A. Owner's responsibility in respect of undisclosed Asbestos, PCBs, Petroleum, Hazardous Waste, or Radioactive Materials uncovered or revealed at the Site is set forth in paragraph 4.04.

## **8.05 Resident Project Representation**

A. Owner may furnish a Resident Project Representative to observe the performance of Construction. The duties, responsibilities and limitations of authority of any such Resident Project Representative and assistants will be as provided in the Supplementary Conditions.

## **8.06 Owner's Consultant**

A. Owner's Consultant, if any, has no duties, responsibilities, or authorities with respect to Design/Builder, unless so provided in the Supplementary Conditions.

# **ARTICLE 9 – CHANGES IN THE WORK; CLAIMS**

---

## **9.01 Authorized Changes in the Work**

A. Without invalidating the Agreement and without notice to any surety, Owner may, at any time or from time to time, order additions, deletions, or revisions in the Work within the general scope of the Contract by a Change Order or a Work Change Directive. Upon receipt of any such document, Design/Builder shall promptly proceed with the Work involved which will be performed under the applicable conditions of the Contract Documents (except as otherwise specifically provided).

## **9.02 Unauthorized Changes in the Work**

A. Design/Builder shall not be entitled to an increase in the Contract Price or an extension of the Contract Times with respect to any Work performed that is not required by the Contract Documents as amended, modified and supplemented as provided in paragraph 3.04, except in the case of an emergency as provided in paragraph 6.16 or in the case of uncovering Construction as provided in paragraph 12.04.

## **9.03 Claims**

A. *Notice.* If Owner and Design/Builder are unable to agree on entitlement to, or on the amount or extent, if any, of an adjustment in the Contract Price or an adjustment of the Contract Times that should be allowed as a result of any order of Owner pursuant to paragraph 9.01.A or other occurrence for which the Contract Documents provide that such adjustment(s) may be made, a Claim may be made therefor. Written notice of intent to make such a Claim shall be submitted to the other party promptly and in no event more than 15 days after the start of the occurrence or event giving rise to the Claim.

B. *Documentation.* Substantiating documentation shall be submitted by the claiming party within 30 days after delivery of the notice required by paragraph 9.03.A.

C. *Decision.* The other party shall render a decision on the Claim no more than 30 days after the receipt of the substantiating documentation required by paragraph 9.03.B. This decision will be final and binding unless the claiming party gives notice of intention to exercise its rights under Article 15 within 30 days of receipt of the decision and exercises such rights within 30 days of giving the notice of intent.

D. *Time Limit Extension.* The time limits of paragraphs 9.03.B and 9.03.C may be extended by mutual agreement.

#### 9.04 Execution of Change Orders

A. Owner and Design/Builder shall execute appropriate Change Orders covering:

1. Changes in the Work which are (i) ordered by Owner pursuant to paragraph 9.01, (ii) required because of acceptance of defective Construction under paragraph 12.08 or Owner's correction of defective Work under paragraph 12.09 or (iii) agreed to by the parties; and

2. Changes in the Contract Price or Contract Times which are agreed to by the parties, including any undisputed sum or amount of time for Work actually performed in accordance with a Work Change Directive.

#### 9.05 Notice to Sureties

A. If notice of any change affecting the general scope of the Work or the provisions of the Contract Documents (including, but not limited to, Contract Price or Contract Times) is required by the provisions of any Bond to be given to a surety, the giving of any such notice will be Design/Builder's responsibility. The amount of each applicable Bond will be adjusted to reflect the effect of any such change.

### ARTICLE 10 – COST OF THE WORK; CASH ALLOWANCES; UNIT PRICE WORK

---

#### 10.01 Cost of the Work

A. *Costs Included.* The term Cost of the Work means the sum of all costs necessarily incurred and paid by Design/Builder in the proper performance of the Work. When the value of Work covered by a Change Order or when a Claim for an adjustment in Contract Price is determined on the basis of Cost of the Work, the costs to be reimbursed to Design/Builder will be only those additional or incremental costs required because of the change of the Work or because of the event giving rise to the Claim. Except as otherwise may be agreed to in writing by Owner, such costs shall be in amounts no higher than those prevailing in the locality of the Project, shall include only the following items, and shall not include any of the costs itemized in paragraph 10.01.B:

1. Payroll costs for employees in the direct employ of Design/Builder in the performance of the Work under schedules of job classifications agreed upon by Owner and Design/Builder.

a. Such employees shall include without limitation superintendents, foremen, and other personnel employed full-time at the Site. Payroll costs for employees not employed full time on the Work shall be apportioned on the basis of their time spent on the Work. Payroll costs shall include, but not be limited to, salaries and wages plus the cost of fringe benefits which shall include social security contributions, unemployment, excise and payroll taxes, workers' compensation, health and retirement benefits, bonuses, sick leave, vacation and holiday pay applicable thereto. The expenses of performing Work after regular working hours, on Saturday, Sunday or legal holidays, shall be included in the above to the extent authorized by Owner.

b. Such employees shall also include engineers, engineering technicians, architects, and others providing Design Professional Services. For purposes of this paragraph 10.01.A.1, Design/Builder shall be entitled to payment for such employees an amount equal to salary costs times a factor, both as designated in the Agreement, for all services performed or furnished by such employees engaged on the Project.

2. Cost of all materials and equipment furnished and incorporated in the Work, including costs of transportation and storage thereof, and Suppliers' field services required in connection therewith. All cash discounts shall accrue to Design/Builder unless Owner deposits funds with Design/Builder with which to make payments, in which case the cash discounts shall accrue to Owner. All trade discounts, rebates and refunds and returns from sale of surplus materials and equipment shall accrue to Owner, and Design/Builder shall make provisions so that they may be obtained.

3. Payments made by Design/Builder to Subcontractors (excluding payments for Design Professional Services pursuant to paragraph 10.01.A.4) for Work performed or furnished by Subcontractors. If any subcontract provides that the Subcontractor is to be paid on the basis of Cost of the Work plus a fee, the Subcontractor's Cost of the Work and fee shall be determined in the same manner as Design/Builder's Cost of the Work and fee.

4. Payments made by Design/Builder for Design Professional Services provided or furnished under a Design Subagreement.

5. Costs of special consultants (including but not limited to testing laboratories, surveyors, attorneys, and accountants) employed for services specifically related to the Work.

6. Supplemental costs including the following items:

a. The proportion of necessary transportation, travel and subsistence expenses of Design/Builder's employees incurred in discharge of duties connected with the Work.

b. Cost, including transportation and maintenance, of all materials, supplies, equipment, machinery, appliances, office and temporary facilities at the Site and hand tools not owned by the workers, which are consumed in the performance of the Work, and cost, less market value, of such items used but not consumed which remain the property of Design/Builder.

c. Rentals of all construction or engineering equipment and machinery and the parts thereof whether rented from Design/Builder or others in accordance with rental agreements approved by Owner, and the costs of transportation, loading, unloading, installation, dismantling and removal thereof. All such costs shall be in accordance with the terms of said rental agreements. The rental of any such equipment, machinery or parts shall cease when the use thereof is no longer necessary for the Work.

d. Sales, consumer, use, and other similar taxes related to the Work, and for which Design/Builder is liable, imposed by Laws or Regulations.

e. Deposits lost for causes other than negligence of Design/Builder, any Subcontractor or anyone directly or indirectly employed by any of them or for whose acts any of them may be liable, and royalty payments and fees for permits and licenses.

f. Losses, damages, and related expenses caused by damage to the Work not compensated by insurance or otherwise, sustained by Design/Builder in connection with the furnishing and performance of the Work provided they have resulted from causes other than the negligence of Design/Builder, any Subcontractor, or anyone directly or indirectly employed by any of them or for whose acts any of them may be liable. Such losses shall include settlements made with the written consent and approval of Owner. No such losses, damages, and expenses shall be included in the Cost of the Work for the purpose of determining Design/Builder's fee.

g. The cost of utilities, fuel, and sanitary facilities at the Site.

h. Minor expenses such as telegrams, long distance telephone calls, telephone service at the Site, expressage, and similar petty cash items in connection with the Work.

i. Cost of premiums for all Bonds and insurance Design/Builder is required by the Contract Documents to purchase and maintain.

B. *Costs Excluded.* The term Cost of the Work shall not include any of the following items:

1. Payroll costs and other compensation of Design/Builder's officers, executives, principals (of partnerships and sole proprietorships), general managers, engineers, architects, estimators, attorneys, auditors, accountants, purchasing and contracting agents, expeditors, timekeepers, clerks and other personnel employed by Design/Builder whether at the Site or in Design/Builder's principal or a branch office for general administration of the Work and not specifically included in the agreed upon schedule of job classifications referred to in paragraph 10.01.A.1, all of which are to be considered administrative costs covered by the Design/Builder's fee.

2. Expenses of Design/Builder's principal and branch offices other than Design/Builder's office at the Site.

3. Any part of Design/Builder's capital expenses, including interest on Design/Builder's capital employed for the Work and charges against Design/Builder for delinquent payments.

4. Costs due to the negligence of Design/Builder, any Subcontractor, or anyone directly or indirectly employed by any of them or for whose acts any of them may be liable, including but not limited to the correction of defective Work, disposal of materials or equipment wrongly supplied, and making good any damage to property.

5. Other overhead or general expense costs of any kind and the costs of any item not specifically and expressly included in paragraph 10.01.A.

C. *Design/Builder's Fee.* When all the Work is performed on the basis of cost-plus, Design/Builder's fee shall be as set forth in the Agreement. When the value of the Work covered by a Change Order is determined on the basis of Cost of the Work, Design/Builder's fee shall be determined as set forth in paragraph 11.01.C.

D. *Documentation.* Whenever the cost of any Work is to be determined pursuant to paragraph 10.01.A and 10.01.B, Design/Builder will establish and maintain records thereof in accordance with generally accepted accounting practices and submit in a form acceptable to Owner an itemized cost breakdown together with supporting data.

## 10.02 Cash Allowances

A. The Contract Price includes all allowances so named in the Contract Documents. Design/Builder shall cause the Work so covered to be performed for such sums as may be acceptable to Owner. Design/Builder agrees that:

1. The allowances include the cost to Design/Builder (less any applicable trade discounts) of materials and equipment required by the allowances to be delivered at the Site, and all applicable taxes; and

2. Except as set forth in the Contract Documents, Design/Builder's costs for unloading and handling on the Site, labor, installation costs, overhead, profit, and other expenses contemplated for the allowances have been included in the Contract Price and not in the allowances, and no demand for additional payment on account of any of the foregoing will be valid.

B. Prior to final payment, an appropriate Change Order will be issued to reflect actual amounts due Design/Builder on account of Work covered by allowances, and the Contract Price shall be correspondingly adjusted.

## 10.03 Unit Prices

A. Where the Contract Documents provide that all or part of the Work is to be Unit Price Work, initially the Contract Price will be deemed to include for all of Unit Price Work an amount equal to the sum of the established unit prices for each separately identified item of Unit Price Work times the estimated quantity of each item as indicated in the Agreement. The estimated quantities of items of Unit Price Work are not guaranteed and are solely for the purpose of comparison of Bids and determining an initial Contract Price. Determinations of the actual quantities and classifications of Unit Price Work performed by Design/Builder will be made by Owner.

B. Each unit price will be deemed to include an amount considered by Design/Builder to be adequate to cover Design/Builder's overhead and profit for each separately identified item.

C. Design/Builder or Owner may make a Claim for an adjustment in the Contract Price in accordance with Article 9 if:

1. the quantity of any item of Unit Price Work performed by Design/Builder differs materially and significantly from the estimated quantity of such item indicated in the Contract Documents;

2. there is no corresponding adjustment with respect to any other item of Work; and

3. Design/Builder believes that it is entitled to an increase in Contract Price as a result of having incurred

additional expense or Owner believes it is entitled to a decrease in Contract Price and the parties are unable to agree as to the amount of any such increase or decrease.

## ARTICLE 11 – CHANGE OF CONTRACT PRICE; CHANGE OF CONTRACT TIMES

---

### 11.01 Change of Contract Price

A. The Contract Price may only be changed by a Change Order. Any Claim for an adjustment in the Contract Price shall be based on written notice delivered by the party making the Claim to the other party promptly in accordance with paragraph 9.03.A.

B. The value of any Work covered by a Change Order or of any Claim for an adjustment in the Contract Price will be determined as follows:

1. Where the Work involved is covered by unit prices contained in the Contract Documents, by application of such unit prices to the quantities of the items involved (subject to the provisions of paragraph 10.03); or

2. Where the Work involved is not covered by unit prices contained in the Contract Documents, by a mutually agreed lump sum (which may include an allowance for overhead and profit not necessarily in accordance with paragraph 11.01.C.2); or

3. Where the Work involved is not covered by unit prices contained in the Contract Documents and agreement to a lump sum is not reached under paragraph 11.01.B.2, on the basis of the Cost of the Work (determined as provided in paragraph 10.01) plus a Design/Builder's Fee for overhead and profit (determined as provided in paragraph 11.01.C).

C. Design/Builder's Fee: The Design/Builder's fee for overhead and profit on Change Orders shall be determined as follows:

1. A mutually acceptable fixed fee; or

2. If a fixed fee is not agreed upon, then a fee based on the following percentages of the various portions of the Cost of the Work:

a. For costs incurred under paragraphs 10.01.A.1.a and 10.01.A.2, the Design/Builder's fee shall be 15 percent;

b. For costs incurred under paragraph 10.01.A.3 10.01.A.4, 10.01.A.5 and 10.01.A.6, the Design/Builder's fee shall be five percent;

c. Where one or more tiers of subcontracts are on the basis of Cost of the Work plus a fee and no fixed fee is agreed upon, the intent of paragraphs 11.01.C.1 and 11.01.C.2.a is that the Subcontractor who actually performs or furnishes Work, at whatever tier, will be paid a fee of 15 percent of the costs incurred by such Subcontractor under paragraphs 10.01.A.1 and 10.01.A.2 and that any higher tier Subcontractor and Design/Builder will each be paid a fee of five percent of the amount paid to the next lower tier Subcontractor;

d. The amount of credit to be allowed by Design/Builder to Owner for any change which results in a net decrease in cost will be the amount of the actual net decrease in cost plus a deduction in Design/Builder's fee by an amount equal to five percent of such net decrease; and

e. When both additions and credits are involved in any one change, the adjustment in Design/Builder's fee shall be computed on the basis of the net change in accordance with paragraphs 11.01.C.2.a through 11.01.C.2.d, inclusive.

## 11.02 Change of Contract Times

A. The Contract Times (or Milestones) may only be changed by a Change Order. Any Claim for an adjustment of the Contract Times (or Milestones) shall be based on written notice pursuant to paragraph 9.03.A.

B. *Delays Beyond Design/Builder's Control.* Where Design/Builder is prevented from completing any part of the Work within the Contract Times (or Milestones) due to delay beyond the control of Design/Builder, the Contract Times (or Milestones) will be extended in an amount equal to the time lost due to such delay if a Claim is made therefor as provided in paragraph 11.02.A. Delays beyond the control of Design/Builder shall include, but not be limited to, acts or neglect by Owner, governmental agencies, acts or neglect of utility owners or other contractors performing other construction work as contemplated by Article 7, fires, floods, epidemics, abnormal weather conditions, or acts of God.

C. If Owner or other contractor or utility owners performing other work for Owner as contemplated by Article 7, or anyone for whom Owner is responsible, delays, disrupts, or interferes with the performance or progress of the Work, then Design/Builder shall be entitled to an equitable adjustment in the Contract Price or the Contract Times, or both. Design/Builder's entitlement to an adjustment of the Contract Times is conditioned on such adjustment being essential to Design/Builder's ability to complete the Work within the Contract Times.

D. If Design/Builder is delayed in the performance or progress of the Work by fire, flood, epidemic, abnormal weather conditions, acts of God, acts or failures to act of utility owners not under the control of Owner, or other causes not the fault of and beyond control of Owner and Design/Builder, then Design/Builder shall be entitled to an equitable adjustment in Contract Times, if such adjustment is essential to Design/Builder's ability to complete the Work within the Contract Times. Such an adjustment shall be Design/Builder's sole and exclusive remedy for the delays described in this Paragraph 11.02.C.

E. Owner and Owner's Consultant shall not be liable to Design/Builder for any claims, costs, losses, or damages (including but not limited to all fees and charges of engineers, architects, attorneys, and other professionals and all court or arbitration or other dispute resolution costs) sustained by Design/Builder on or in connection with any other project or anticipated project.

F. Design/Builder shall not be entitled to an adjustment in Contract Price or Contract Times for delays within the control of Design/Builder. Delays attributable to and within the control of a Subcontractor or Supplier shall be deemed to be delays within the control of Design/Builder.

## ARTICLE 12 – TESTS AND INSPECTIONS; CORRECTION, REMOVAL OR ACCEPTANCE OF DEFECTIVE CONSTRUCTION

---

### 12.01 Notice of Defects

A. Owner shall give Design/Builder prompt written notice of all defective Construction of which Owner has actual knowledge. All defective Construction may be rejected, corrected or accepted as provided in this Article 12.

### 12.02 Access to Construction

A. Owner, Owner's Consultants, other representatives and personnel of Owner, independent testing laboratories and governmental agencies with jurisdictional interests will have access to the Site and the Construction at reasonable times for their observation, inspecting, and testing. Design/Builder shall provide them proper and safe conditions for such access and advise them of Design/Builder's Site safety procedures and programs so that they may comply therewith as applicable.

### 12.03 Tests and Inspections

A. If the Contract Documents or Laws or Regulations of any public body having jurisdiction require any part of the Construction specifically to be inspected, tested or approved, Design/Builder shall assume full responsibility for arranging and obtaining such inspections, tests or approvals, pay all

costs in connection therewith, and furnish Owner the required certificates of inspection or approval. Design/ Builder shall also be responsible for arranging and obtaining and shall pay all costs in connection with any inspections, tests, or approvals required for Owner's acceptance of materials or equipment to be incorporated in the Work or of materials, mix designs, or equipment submitted for approval prior to Design/Builder's purchase thereof for incorporation in the Work.

B. Design/Builder shall give Owner reasonable notice of the planned schedule for all required inspections, tests, or approvals.

C. If any Construction (or the construction work of others) that is required to be inspected, tested, or approved is covered by Design/Builder without written concurrence of Owner, it must, if requested by Owner, be uncovered for observation at Design/Builder's expense unless Design/Builder has given Owner timely notice of Design/Builder's intention to cover the same and Owner has not acted with reasonable promptness in response to such notice.

#### **12.04 Uncovering Construction**

A. If any Construction is covered contrary to the written request of Owner, it must, if requested by Owner, be uncovered for Owner's observation and recovered at Design/Builder's expense.

B. If Owner considers it necessary or advisable that covered Construction be observed by Owner or inspected or tested by others, Design/Builder, at Owner's request, shall uncover, expose or otherwise make available for observation, inspection or testing as Owner may require, that portion of the Construction in question, furnishing all necessary labor, material and equipment. If it is found that such Construction is defective, Design/Builder shall pay all costs and damages caused by or resulting from such uncovering, exposure, observation, inspection and testing and of satisfactory replacement or reconstruction, (including but not limited to all fees and charges of engineers, architects, attorneys and other professionals, all court or arbitration or other dispute resolution costs, and all costs of repair or replacement of work of others); and Owner shall be entitled to an appropriate decrease in the Contract Price, and, if the parties are unable to agree as to the amount thereof, Owner may make a Claim therefor as provided in Article 9. If, however, such Construction is not found to be defective, Design/Builder shall be allowed an increase in the Contract Price or an extension of the Contract Times (or Milestones), or both, directly attributable to such uncovering, exposure, observation, inspection, testing, replacement and reconstruction. If the parties are unable to agree as to the amount or extent thereof, Design/Builder may make a Claim therefor as provided in Article 9.

#### **12.05 Owner May Stop Construction**

A. If Construction is defective, or Design/Builder fails to supply sufficient skilled workers or suitable materials or equipment, or fails to furnish or perform Construction in such a way that the completed Construction will conform to the Contract Documents, Owner may order Design/Builder to stop Construction or any portion thereof, until the cause for such order has been eliminated; however, this right of Owner to stop Construction will not give rise to any duty on the part of Owner to exercise this right for the benefit of Design/Builder or any other party.

#### **12.06 Correction or Removal of Defective Construction**

A. Owner will have authority to disapprove or reject defective Construction and will have authority to require special inspection or testing of the Construction whether or not the Construction is fabricated, installed or completed. If required by Owner, Design/Builder shall promptly, as directed, either correct all defective Construction, whether or not fabricated, installed or completed, or, if the Construction has been rejected by Owner, remove it from the Site and replace it with non-defective Construction. Design/Builder shall bear all direct, indirect, and consequential costs of such correction or removal (including but not limited to fees and charges of engineers, architects, attorneys and other professionals and all court, arbitration, or other dispute resolution costs) arising out of or relating to such correction or removal.

#### **12.07 Correction Period**

A. If within one year after the date of Substantial Completion of the entire Work or such longer period of time as may be prescribed by Laws or Regulations or by the terms of any applicable special guarantee required by the Contract Documents or by any specific provision of the Contract Documents, any Construction is found to be defective, Design/Builder shall promptly, without cost to Owner and in accordance with Owner's written instructions, (i) correct such defective Construction, or, if it has been rejected by Owner, remove it from the Site and replace it with Construction that is not defective, and (ii) satisfactorily correct or remove and replace any damage to other Construction or the work of others resulting therefrom. If Design/Builder does not promptly comply with the terms of such instructions, or in an emergency where delay would cause serious risk of loss or damage, Owner may have the defective Construction corrected or the rejected Construction removed and replaced, and all costs, losses, and damages caused by or resulting from such removal and replacement (including but not limited to all fees and charges of engineers, architects, attorneys and other professionals, all court or arbitration or other dispute resolution costs, and all costs of repair or replacement of work of others) will be paid by Design/Builder.

B. In special circumstances where a particular item of equipment is placed in continuous service before Substantial



Completion of all the Work, the correction period for that item may start to run from an earlier date if so provided in the Conceptual Documents.

C. Where defective Construction (and damage to other Construction resulting therefrom) has been corrected, removed or replaced under this paragraph 12.07, the correction period hereunder with respect to such Construction will be extended for an additional period of one year after such correction or removal and replacement has been satisfactorily completed.

#### **12.08 Acceptance of Defective Construction**

A. If, instead of requiring correction or removal and replacement of defective Construction, Owner prefers to accept it, Owner may do so. Design/Builder shall pay all costs, losses, and damages (including but not limited to all fees and charges of engineers, architects, attorneys and other professionals and all court or arbitration or other dispute resolution costs) attributable to Owner's evaluation of and determination to accept such defective Construction. If any such acceptance occurs prior to final payment, a Change Order will be issued incorporating the necessary revisions in the Contract Documents, and Owner shall be entitled to an appropriate decrease in the Contract Price reflecting the diminished value of the Construction so accepted. If the parties are unable to agree as to the amount thereof, Owner may make a Claim therefor as provided in Article 9. If the acceptance occurs after final payment, an appropriate amount will be paid by Design/Builder to Owner.

#### **12.09 Owner May Correct Defective Construction**

A. If Design/Builder fails within a reasonable time after written notice from Owner to correct defective Construction or to remove and replace rejected Construction as required by Owner in accordance with paragraphs 12.06.A or 12.07.A, or if Design/Builder fails to perform the Construction in accordance with the Contract Documents, or if Design/Builder fails to comply with any other provision of the Contract Documents, Owner may, after seven days' written notice to Design/Builder, correct and remedy any such deficiency.

B. In exercising the rights and remedies under this paragraph 12.09 Owner shall proceed expeditiously. In connection with such corrective and remedial action, Owner may exclude Design/Builder from all or part of the Site, take possession of all or part of the Construction, and suspend Design/Builder's services related thereto, take possession of Design/Builder's tools, appliances, construction equipment and machinery at the Site, and incorporate in the Construction all materials and equipment stored at the Site or for which Owner has paid Design/Builder but which are stored elsewhere. Design/Builder shall allow Owner, Owner's Consultant, Owner's representatives, agents, employees, and other contractors access to the Site to enable Owner to exercise the rights and remedies under this paragraph.

C. All costs, losses, and damages (included but not limited to fees and charges of engineers, architects, attorneys and other professionals, all court or arbitration or other dispute resolution costs and all costs of repair or replacement of work of others) incurred or sustained by Owner in exercising such rights and remedies under this paragraph 12.09 will be charged against Design/Builder and a Change Order will be issued incorporating the necessary revisions in the Contract Documents, and Owner shall be entitled to an appropriate decrease in the Contract Price. If the parties are unable to agree as to the amount thereof, Owner may make a Claim therefor as provided in Article 9.

D. Design/Builder shall not be allowed an extension of the Contract Times (or Milestones) because of any delay in the performance of the Work attributable to the exercise by Owner of Owner's rights and remedies under this paragraph 12.09.

### **ARTICLE 13 – PAYMENTS TO DESIGN/BUILDER AND COMPLETION**

---

#### **13.01 Schedule of Values**

A. The Schedule of Values established as provided in paragraph 2.06.A will serve as the basis for progress payments. Progress payments on account of Unit Price Work will be based on the number of units completed.

#### **13.02 Application for Progress Payment**

A. On or about the date established in the Agreement for submission of each application for progress payment (but not more often than once a month), Design/Builder shall submit to Owner for review an Application for Payment filled out and signed by Design/Builder covering the Work completed as of the date indicated on the Application and accompanied by supporting documentation as required by the Contract Documents. If payment is requested on the basis of materials and equipment not incorporated in the Work but delivered and suitably stored at the Site or at another location agreed to in writing, the Application for Payment shall also be accompanied by a bill of sale, invoice or other documentation warranting that Owner has received the materials and equipment free and clear of all Liens and evidence that the materials and equipment are covered by appropriate property insurance and other arrangements to protect Owner's interest therein, all of which will be satisfactory to Owner.

B. Beginning with the second Application for Payment, each Application shall include an affidavit of Design/Builder stating that all previous progress payments received on account of the Work have been applied on account to discharge Design/Builder's legitimate obligations associated with prior Applications for Payment.

C. The amount of retainage with respect to progress payments will be as stipulated in the Agreement.

### **13.03 Progress Payments**

A. *Procedure.* Progress payments shall be made by the Owner to the Design/Builder according to the following procedure:

1. Owner will, within ten days of receipt of each Application for Payment, either indicate in writing its acceptance of the Application and state that the Application is being processed for payment, or return the Application to Design/Builder indicating in writing its reasons for refusing to accept the Application. Not more than ten days after accepting such Application the amount will become due and when due will be paid by Owner to Design/Builder.

2. If Owner should fail to pay Design/Builder at the time the payment of any amount becomes due, then Design/Builder may, at any time thereafter, upon serving written notice that he will stop the Work within seven days after receipt of the notice by Owner, and after such seven day period, stop the Work until payment of the amount owing has been received. Written notice shall be deemed to have been duly served if sent by certified mail to the last known business address of Owner.

3. Payments due but unpaid shall bear interest at the rate specified in the Agreement.

4. No Progress Payment nor any partial or entire use or occupancy of the Project by Owner shall constitute an acceptance of any Work not in accordance with the Contract Documents.

B. *Reduction in or Refusal to Make Payment.* Owner may refuse to make the whole or any part of any such payment, or because of subsequently discovered evidence or the results of subsequent inspections or tests, nullify any previous payment, to the extent that is reasonably necessary to protect Owner from loss because:

1. the Construction is defective, or completed Construction has been damaged requiring correction or replacement; or

2. the Contract Price has been reduced by Change Order; or

3. Owner has been required to correct defective Construction or complete Work in accordance with paragraph 12.09.A; or

4. Owner has actual knowledge of the occurrence of any of the events enumerated in paragraphs 14.02.A.; or

5. Claims have been made against Owner on account of Design/Builder's performance or furnishing of the Work; or

6. Liens have been filed in connection with the Work, except where Design/Builder has delivered a specific Bond satisfactory to Owner to secure the satisfaction and discharge of such Liens; or

7. There are other items entitling Owner to a set off against the amount for which application is made.

C. If Owner refuses to make payment of the full amount requested by Design/Builder, Owner must give Design/Builder immediate written notice stating the reasons for such action and promptly pay Design/Builder any amount remaining after deduction of the amount withheld. Owner shall promptly pay Design/Builder the amount withheld or any adjustment thereto agreed to when Design/Builder corrects to Owner's satisfaction the reason for such action.

### **13.04 Design/Builder's Warranty of Title**

A. Design/Builder warrants and guarantees that title to all Construction, materials, and equipment covered by any Application for Payment, whether incorporated in the Project or not, will pass to Owner no later than the time of payment free and clear of all Liens.

### **13.05 Substantial Completion**

A. When Design/Builder considers the Work ready for its intended use Design/Builder shall notify Owner in writing that the Work is substantially complete (except for items specifically listed by Design/Builder as incomplete) and request that Owner issue a certificate of Substantial Completion. Promptly thereafter, Owner and Design/Builder shall make an inspection of the Work to determine the status of completion. If Owner does not consider the Work substantially complete, Owner will notify Design/Builder in writing giving the reasons therefor. If Owner considers the Work substantially complete, Owner will prepare and deliver to Design/Builder a certificate of Substantial Completion which shall fix the date of Substantial Completion. There shall be attached to the certificate a list of items to be completed or corrected before final payment. At the time of delivery of the certificate of Substantial Completion Owner will deliver to Design/Builder a written determination as to division of responsibilities pending final payment between Owner and Design/Builder with respect to security, operation, safety, protection of Construction, maintenance, heat, utilities, insurance and warranties and guarantees.

B. Owner will have the right to exclude Design/Builder from the Site after the date of Substantial Completion, but Owner will allow Design/Builder reasonable access to complete or correct items on the list of items to be completed.

### **13.06 Partial Utilization**

A. Prior to Substantial Completion of all the Work, Owner may use or occupy any substantially completed part of the Construction which (i) has specifically been identified in the Contract Documents, or (ii) Owner and Design/Builder agree constitute a separately functioning and usable part of the Construction that can be used by Owner for its intended purpose without significant interference with Design/ Builder's performance of the remainder of the Construction, subject to the following:

1. Owner at any time may request Design/Builder in writing to permit Owner to use or occupy any such part of the Construction which Owner believes to be ready for its intended use and substantially complete. If Design/Builder agrees that such part of the Work is substantially complete, Design/Builder will certify to Owner that such part of the Construction is substantially complete and request Owner to issue a certificate of Substantial Completion for that part of the Construction. Design/Builder at any time may notify Owner in writing that Design/Builder considers any such part of the Work ready for its intended use and substantially complete and request Owner to issue a certificate of Substantial Completion for that part of the Work. Within a reasonable time after either such request, Owner and Design/Builder shall make an inspection of that part of the Work to determine its status of completion. If Owner does not consider that part of the Work to be substantially complete, Owner will notify Design/Builder in writing giving the reasons therefor. If Owner considers that part of the Work to be substantially complete, the provisions of paragraph 13.05 will apply with respect to certification of Substantial Completion of that part of the Work and the division of responsibility in respect thereof and access thereto.

2. No use or occupancy of part of the Construction will be accomplished prior to compliance with the requirements of paragraph 5.10 regarding property insurance.

### **13.07 Final Inspection**

A. Upon written notice from Design/Builder that the entire Work or an agreed portion thereof is complete, Owner will make a final inspection with Design/Builder and will notify Design/Builder in writing of all particulars in which this inspection reveals that the Work is incomplete or defective. Design/Builder shall immediately take such measures as are necessary to complete such Work or remedy such deficiencies.

### **13.08 Final Payment**

A. Application for Payment.

1. After Design/Builder has completed all such corrections to the satisfaction of Owner and delivered in

accordance with the Contract Documents all maintenance and operating instructions, schedules, guarantees, Bonds, certificates or other evidence of insurance, certificates of inspection, record documents (as provided in paragraph 6.12) and other documents, Design/Builder may make application for final payment following the procedure for progress payments.

2. The final Application for Payment shall be accompanied (unless previously delivered) by: (i) all documentation called for in the Contract Documents, including but not limited to the evidence of insurance required by paragraph 5.04.B.7; (ii) consent of the surety, if any, to final payment; and (iii) complete and legally effective releases or waivers (satisfactory to Owner) of all Liens arising out of or filed in connection with the Work.

3. In lieu of such releases or waivers of Liens specified in paragraph 13.08.A.2 and as approved by Owner, Design/Builder may furnish receipts or releases in full and an affidavit of Design/Builder that: (i) the releases and receipts include all labor, services, material and equipment for which a Lien could be filed, and (ii) all payrolls, material and equipment bills and other indebtedness connected with the Work for which Owner or Owner's property might in any way be responsible have been paid or otherwise satisfied. If any Subcontractor or Supplier fails to furnish such a release or receipt in full, Design/Builder may furnish a Bond or other collateral satisfactory to Owner to indemnify Owner against any Lien.

*B. Final Payment and Acceptance.* If Owner is satisfied that the Work has been completed and Design/Builder's other obligations under the Contract Documents have been fulfilled, Owner will, within ten days after receipt of the final Application for Payment, give written notice to Design/Builder that the Work is acceptable. Otherwise, Owner will return the Application to Design/Builder, indicating in writing the reasons for refusing to process final payment, in which case Design/Builder shall make the necessary corrections and resubmit the Application.

*C. Payment Becomes Due.* Thirty days after the presentation to Owner of the acceptable Application and accompanying documentation, in appropriate form and substance and with Owner's notice of acceptability, the amount will become due and will be paid by Owner to Design/Builder.

### **13.09 Final Completion Delayed**

A. If, through no fault of Design/Builder, final completion of the Work is significantly delayed, Owner shall, upon receipt of Design/Builder's final Application for Payment, and without terminating the Agreement, make payment of the balance due for that portion of the Work fully completed and accepted. If the remaining balance to be held

by Owner for Work not fully completed or corrected is less than the retainage stipulated in the Agreement, and if Bonds have been furnished as required in paragraph 5.01.A, the written consent of the surety to the payment of the balance due for that portion of the Work fully completed and accepted shall be submitted by Design/Builder to Owner with the Application for such payment. Such payment shall be made under the terms and conditions governing final payment, except that it shall not constitute a waiver of Claims.

### **13.10 Waiver of Claims**

A. The making and acceptance of final payment will constitute:

1. A waiver of all Claims by Owner against Design/Builder, except Claims arising from unsettled Liens, from defective Construction appearing after final inspection pursuant to paragraph 13.07, from failure to comply with the Contract Documents or the terms of any special guarantees specified therein, or from Design/Builder's continuing obligations under the Contract Documents; and

2. A waiver of all Claims by Design/Builder against Owner other than those previously made in writing and still unsettled.

## **ARTICLE 14 – SUSPENSION OF WORK AND TERMINATION**

---

### **14.01 Owner May Suspend Work**

A. At any time and without cause, Owner may suspend the Work or any portion thereof for a period of not more than 90 days by notice in writing to Design/Builder which will fix the date on which Work will be resumed. Design/Builder shall resume the Work on the date so fixed. Design/Builder shall be allowed an adjustment in the Contract Price or an extension of the Contract Times, or both, directly attributable to any such suspension if Design/Builder makes a Claim therefor as provided in Article 9.

### **14.02 Owner May Terminate for Cause**

A. The occurrence of any one or more of the following events justifies termination for cause:

1. Design/Builder's persistent failure to perform the Work in accordance with the Contract Documents (including, but not limited to, failure to supply sufficient skilled workers or suitable materials or equipment or failure to adhere to the progress schedule established under paragraph 2.06.A as adjusted from time to time pursuant to paragraph 6.05).

2. Design/Builder's disregard of Laws or Regulations of any public body having jurisdiction.

3. Design/Builder's violation in any substantial way of provisions of the Contract Documents.

B. If one or more of the events identified in paragraph 14.02.A occur, Owner may, after giving Design/Builder (and the surety, if any) seven days' written notice, terminate the services of Design/Builder, take possession of any completed Drawings and Specifications prepared by or for Design/Builder (subject to the indemnification provisions of paragraph 3.05.A), exclude Design/Builder from the Site, and take possession of the Work and of all Design/Builder's tools, appliances, construction equipment and machinery at the Site and use the same to the full extent they could be used by Design/Builder (without liability to Design/Builder for trespass or conversion), incorporate in the Work all materials and equipment stored at the Site or for which Owner has paid Design/Builder but which are stored elsewhere, and finish the Work as Owner may deem expedient. In such case Design/Builder shall not be entitled to receive any further payment until the Work is finished. If the unpaid balance of the Contract Price exceeds all costs, losses and damages sustained by Owner arising out of or resulting from completing the Work (including but not limited to all fees and charges of engineers, architects, attorneys and other professionals and all court or arbitration or other dispute resolution costs) such excess will be paid to Design/Builder. If such costs, losses and damages exceed such unpaid balance, Design/Builder shall pay the difference to Owner. Such costs, losses and damages incurred by Owner will be incorporated in a Change Order. When exercising any rights or remedies under this paragraph Owner shall not be required to obtain the lowest price for the Work performed.

C. Notwithstanding paragraph 14.02.B, Design/Builder's services will not be terminated if Design/Builder begins, within seven days of receipt of notice of intent to terminate, to correct its failure to perform and proceeds diligently to cure such failure within no more than 30 days of receipt of said notice.

D. Where Design/Builder's services have been so terminated by Owner, the termination will not affect any rights or remedies of Owner against Design/Builder then existing or which may thereafter accrue. Any retention or payment of moneys due Design/Builder by Owner will not release Design/Builder from liability.

### **14.03 Owner May Terminate for Convenience**

A. Upon seven days' written notice to Design/Builder, Owner may, without cause and without prejudice to any other right or remedy of Owner, elect to terminate the Contract. In such case, Design/Builder shall be paid (without duplication of any items) for:

1. Completed and acceptable Work executed in accordance with the Contract Documents prior to the effective date of termination, including fair and reasonable sums for overhead and profit on such Work;

2. Expenses sustained prior to the effective date of termination in performing services and furnishing labor, materials or equipment as required by the Contract Documents in connection with uncompleted Work, plus fair and reasonable sums for overhead and profit on such expenses;

3. Amounts paid in settlement of terminated contracts with Subcontractors, Suppliers and others (including but not limited to all fees and charges of engineers, architects, attorneys and other professionals and all court or arbitration or other dispute resolution costs incurred in connection with termination of contracts with Subcontractors, Suppliers and others); and

4. Reasonable expenses directly attributable to termination.

B. Except as provided in paragraph 14.03.C, Design/Builder shall not be paid on account of loss of anticipated profits or revenue or other economic loss arising out of or resulting from such termination.

#### **14.04 Design/Builder May Stop Work or Terminate**

A. If, through no act or fault of Design/Builder, the Work is suspended for a period of more than 90 days by Owner or under an order of court or other public authority, or Owner fails to act on any Application for Payment within thirty days after it is submitted or Owner fails for thirty days to pay Design/Builder any sum finally determined to be due, then Design/Builder may, upon seven days' written notice to Owner, and provided Owner does not remedy such suspension or failure within that time, terminate the Agreement and recover from Owner payment on the same terms as provided in paragraph 14.03.A. In lieu of terminating the Agreement and without prejudice to any other right or remedy, if Owner has failed for 30 days to pay Design/Builder any sum finally determined to be due, Design/Builder may upon seven days' written notice to Owner stop the Work until payment is made of all such amounts due Design/Builder, including interest thereon. The provisions of this paragraph 14.04.A are not intended to preclude Design/Builder from making Claim under Article 9 for an increase in Contract Price or Contract Times or otherwise for expenses or damage directly attributable to Design/Builder's stopping Work as permitted by this paragraph.

### **ARTICLE 15 – DISPUTE RESOLUTION**

---

#### **15.01 Methods and Procedures**

A. Dispute resolution methods and procedures, if any, shall be as set forth in the Supplementary Conditions. If no such method and procedure has been set forth, Owner and Design/Builder may exercise such rights or remedies as either may otherwise have under the Contract Documents or by Laws or Regulations in respect of any dispute.

### **ARTICLE 16 – MISCELLANEOUS**

---

#### **16.01 Giving Notice**

A. Whenever any provision of the Contract Documents requires the giving of written notice, it will be deemed to have been validly given if delivered in person to the individual or to a member of the firm or to an officer of the corporation for whom it is intended, or if delivered at or sent by certified mail, postage prepaid, to the last business address known to the giver of the notice.

#### **16.02 Computation of Times**

A. When any period of time is referred to in the Contract Documents by days, it will be computed to exclude the first and include the last day of such period. If the last day of any such period falls on a Saturday or Sunday or on a day made a legal holiday by the law of the applicable jurisdiction, such day will be omitted from the computation.

#### **16.03 Cumulative Remedies**

A. The duties and obligations imposed by these General Conditions and the rights and remedies available hereunder to the parties hereto are in addition to, and are not to be construed in any way as a limitation of, any rights and remedies available to any or all of them which are otherwise imposed or available by:

1. Laws or Regulations; or
2. any special warranty or guarantee; or
3. other provisions of the Contract Documents.

B. The provisions of paragraph 16.03.A will be as effective as if repeated specifically in the Contract Documents in connection with each particular duty, obligation, right and remedy to which they apply.

#### **16.04 Survival of Obligations**

A. All representations, indemnifications, warranties and guarantees made in, required by or given in accordance with the Contract Documents, as well as all continuing obligations indicated in the Contract Documents, will survive

final payment, completion and acceptance of the Work and termination or completion of the Contract.

**16.05 *Controlling Law***

A. The Contract Documents will be construed in accordance with the law of the place of the Project.

**California American Water**  
**Fitch Park ASR Wells 5 & 6 Above Ground Facilities**

---

SUPPLEMENTARY CONDITIONS

The Supplementary Conditions amend or supplement the General Conditions (Standard General Conditions of the Contract between Owner and Design/Builder, 2002 Edition, EJCDC D-700) and other provisions of the Contract Documents as indicated below. All provisions which are not so amended or supplemented remain in full force and affect.

Table of Contents

Article No.	Title	Page
SC-1.01	Definitions	SC-3
SC-1.02	Terminology	SC-3
SC-2.02	Commencement of Contract Times; Notice to Proceed	SC-3
SC-2.05	Initial Conference	SC-3
SC-3.05	Reuse of Documents	SC-4
SC-4.03	Reference Points	SC-4
SC-4.04	Hazardous Environmental Conditions at Site	SC-5
SC-5.01	Performance, Payment and Other Bonds	SC-5
SC-5.04	Design/Builders Liability Insurance	SC-6
SC-5.06	Property Insurance	SC-8
SC-5.07	Waiver of Rights	SC-10
SC-6.01	Design Professional Services	SC-10
SC-6.04	Major Materials and Equipment	SC-11
SC-6.06	Subcontractors, Suppliers and Others	SC-11
SC-6.08	Permits	SC-11
SC-6.10	Taxes	SC-11

**California American Water  
Fitch Park ASR Wells 5 & 6 Above Ground Facilities**

---

Table of Contents (cont.'d)

Article No.	Title	Page
SC-8.01	Owners Responsibilities - General	SC-12
SC-8.05	Resident Project Representations	SC-12
SC-10.01	Cost of the Work	SC-14
SC-11	Change of Contract Price	SC-15
SC-12.03	Tests and Inspections	SC-16
SC-13.03	Progress Payments	SC-16
SC-13.06	Partial Utilization	SC-16
SC-13.08	Final Application for Payment	SC-16
Appendix A	Sample Certificate of Insurance	
Appendix B	Release of Liens	
Appendix C	Guidelines For State Contractors	



**SUPPLEMENTARY CONDITIONS**

The terms used in these Supplementary Conditions that are defined in the Standard General Conditions of the Contract between Owner and Design/Builder (EJCDC D-700, 2002 Edition) have the meanings assigned to them in the General Conditions.

**SC-1.01 Definitions**

Delete paragraph 1.01.A.27 of the General Conditions in its entirety and insert the following in its place:

27. Contract times will commence to run on the Effective Date of the Agreement.

Add the following definitions after General Conditions 1.01.A.48

49. Target Cost – The Target Cost for the Work shall be defined as follows:
- a. After award of the contract, the Design/Builder shall prepare and submit a preliminary budget construction cost estimate with the Design Memorandum. Section III, Scope of Design Services, Paragraph A.9. included in the RFP provides a brief description of this requirement.
  - b. Upon completion of 60% design, including incorporation of Owner's comments, the Design/Builder shall develop and present a final detailed estimate of the cost of the construction activities to the Owner. The Supplementary Conditions, SC-6.01 Design Professional Services, and SC-10.01 Cost of the Work included in the RFP provides a detailed description of this requirement.

**SC-1.02 Terminology**

Add the following terms after General Conditions 1.02.A.7

- 8. Whenever the term "Water Company" is used in these Contract Documents, it shall have the same meaning as Owner.
- 9. Whenever the terms CONTRACTOR or CONSULTANT (upper or lower case spellings) is used it shall have the same meaning as Design/Builder.

**SC-2.02 Commencement of Contract Times; Notice to Proceed**

Delete paragraph 2.02.A of the General Conditions in its entirety and insert the following in its place:

The Contract Times will commence to run on the Effective Date of the Agreement.

**SC-2.05 Initial Conference**

Delete paragraph 2.05 of the General Conditions in its entirety and insert the following in its place:

Within twenty-five (25) days after the Contract Times start to run, two consecutive one-day meetings will be held. The first day, a conference attended by Design/Builder, Owner, and others shall be held with the assistance of a Facilitator in order to establish a Partnering relationship amongst the parties as to the Work. At such conference, the parties shall develop common Project objectives in the form of a partnering charter and shall develop working arrangements for periodic meetings amongst the Parties, including subsequent partnering meetings, and for the rapid resolution of issues that may develop. Owner and Design/Builder shall mutually agree on the selection of the Facilitator. The cost of the Facilitator and the cost of the meeting facilities for all partnering sessions will be paid for by the Owner. Each party shall be responsible for the travel and living expenses of their employees and their subcontractors or consultants designated to attend the meeting. On the second day, Design/Builder, Owner and others shall attend another meeting to discuss the schedules referred to in paragraph 2.04 of the General Conditions, design issues, processing shop drawings, Applications for Payments and other submittals, maintaining required records and Project procedures and Community Relations. See Scope of Design Services and Section 1000 Summary of Work for additional meeting attendance requirements.

### **SC-3.05 Reuse of Documents**

Delete paragraph 3.05.A of the General Conditions in its entirety and insert the following in its place:

Drawings, specifications, and other work products of the Design/Builder for this project, except working notes and internal documents, become the property of the Owner upon delivery thereof to Owner and payment for the services that produced said documents in accordance with this Agreement. Reuse of any of these drawings, specifications, or other work products of the Design/Builder by the Owner for other than the specific project covered in this Agreement, or modification and use by the Owner of any documents connected with this Agreement, without the written permission of the Design/Builder shall be at the Owner's risk and the Owner agrees to defend, indemnify, and hold harmless the Design/Builder from all claims, damages and expenses including attorney's fees arising out of such unauthorized reuse of the Design/Builder work product by the Owner or by others acting through the Owner. The Design/Builder shall be entitled to a reproducible copy of all material furnished to the Owner. Any uncompleted work of the Design/Builder delivered to the Owner due to cancellation of all or portions of the work or contract termination, which are utilized by the Owner in any way, shall have the Design/Builder name removed, and the Owner agrees to defend, indemnify, and hold harmless the Design/Builder from all claims, damages, and expenses including attorney's fees arising from any use by Owner of such uncompleted work.

### **SC-4.03 Reference Points**

Amend the first sentence of paragraph 4.03.A of the General Conditions to read as follows:

Design/Builder shall be responsible for laying out the construction and shall protect and preserve the reference points established by Design/Builder and shall make no changes or relocations without the prior written approval of Owner.

#### **SC-4.04 Hazardous Environmental Conditions at Site**

Add a new paragraph immediately after paragraph 4.04.F, which is to read as follows:

G. Owner, Design/Builder and any Subcontractors will each provide or make available to the others: (a) any written hazard communication program required to be maintained with respect to the site and any material data sheet and other hazard communication required to be provided in accordance with applicable Laws and applicable Regulations, or (b) in the event that applicable Laws and Regulations do not require the provision or exchange of such hazard communications, Design/Builder and any Subcontractors shall, nevertheless, provide or make available to Owner and any other employers at the site a written hazard communication program, material safety data sheets and any other hazard communication information of the type consistent with the intent of OSHA Standard Section 29CFR-1910.12 and acceptable to Owner. Design/Builder shall be responsible for coordinating any such required exchange of documents or information between or among Owner, and any other employers at the site, or any of them. Design/Builder shall include the provisions of this paragraph SC-4.04.G in any subcontract for any part of the Work at the site.

#### **SC-5.01 Performance, Payment and Other Bonds**

Delete Paragraph 5.01 of the General Conditions in its entirety and replace with the following:

A. Design/Builder agrees to include in its subcontracts with major subcontractors a requirement for such subcontractors to furnish a Performance Bond and a Labor and Material Payment Bond, each in an amount equal to the Subcontract price and each naming the Owner and Design/Builder as co-obligees, as security for the faithful performance and payment of all such subcontractors' obligations under their respective subcontract documents. These Bonds shall remain in effect at least until one year after the date when final payment becomes due, except as otherwise provided by Laws or Regulations. All bonds furnished in compliance with the above shall be executed by sureties having a rating of "A" by the most recent Best's Key Rating Guide and as are named in the current list of "Companies Holding Certificates of Authority as Acceptable Sureties on Federal Bonds and as Acceptable Reinsuring Companies" as published in Circular 570 (amended) by the Audit Staff, Bureau of Government Financial Operations, U.S. Treasury Department. All Bonds signed by an agent must be accompanied by a certified copy of such agent's authority to act.

B. Design/Builder is not required to furnish a Performance or Labor and Material Payment Bond at the time of award. If Owner requests at a later date that such bonds be furnished, Design/Builder will provide the bonds from a surety meeting the requirements of Paragraph 5.01A above. In this case Design/Builder's Fee will be increased in an amount equal to the premium paid for the bonds requested by Owner.

## SC-5.04 Design/Builder's Liability Insurance

The limits of liability for the insurance required by paragraph 5.04 of the General Conditions shall provide coverage for not less than the following amounts or greater where required by Laws and Regulations:

1. At no expense to Owner, Design/Builder and subcontractors shall (1) obtain and keep in force during the term of this Agreement, and any renewals or extensions hereof; and (2) require its subcontractors to obtain and keep in force during the terms of their respective engagements or contracts, the minimum insurance limits and coverage set forth below. The insurance coverage limits stated below are minimum coverage requirements, not limitations of liability, and shall not be construed in any way as Owner's acceptance of the responsibility of Design/Builder.

### a. Commercial General Liability:

- **\$(See Appendix A)** per occurrence Combined Single Limits.
- **\$(See Appendix A)** General Aggregate.
- **\$(See Appendix A)** Products and Completed Operations Aggregate.
- **\$( See Appendix A)** Completed Operation-Products Liability

CGL ISO 1996 or later occurrence form including premises and operations coverage, products and completed operations, coverage for independent contractors, personal injury coverage and blanket contractual liability, contractors protective liability if Design/Builder subcontracts all or any portion of the work to be performed hereunder. Completed operations shall be maintained for a period of three (3) years following final completion for any construction, renovation, repair and maintenance service.

### b. Workers' Compensation:

- Coverage A: Applicable federal or state requirements: statutory minimum.
- Coverage B: Employer's Liability:
- Each accident: **\$(See Appendix A).**
- Each employee – disease: **\$(See Appendix A).**
- Policy limit - disease: **\$(See Appendix A).**
- Coverage C: Voluntary workers compensation insurance coverage for all employees not subject to the applicable workers compensation act or acts.

The workers' compensation policy shall also include U.S. longshoreman and harbors workers' compensation act coverage if any work to be performed hereunder shall be done over or within one hundred (100) feet of any body of water, or otherwise at the sole discretion of Owner. Design/Builder shall provide maritime (Jones Act) coverage if a boat or vessel of any type is used.

### c. Automotive Liability (including owned, hired, borrowed and non-ownership liability)

- Bodily injury and property damage **\$( See Appendix A)** each occurrence Combined Single Limits.

**d. Umbrella Liability**

- **\$( See Appendix A)** each occurrence and annual aggregate in excess of employer's liability, General liability and Automotive liability (no more restrictive than underlying insurance).

**e. Professional Liability Insurance**

- The Design/Builder shall carry Professional Liability Insurance covering Design/Builder's liabilities for loss due to error, omission, negligence, mistakes or failure to take appropriate action in the performance of business or professional duties of their employees during the life of the Contract with the limits meeting those shown in the sample Certificate of Insurance included in **Appendix A** of these Supplementary Conditions
2. The minimum liability limits required may be satisfied through the combination of the primary general liability, employers' liability, and automotive liability limits with an umbrella liability policy (with coverage no more restrictive than the underlying insurance) providing excess limits at least equal to or greater than the combined primary limits.
  3. All commercial general liability including completed operations-products liability coverage and automotive liability insurance shall designate Owner, its parent, affiliates and subsidiaries, its directors, officers and employees as an additional insured. All such insurance should be primary and non-contributory, and is required to respond and pay prior to any other insurance or self-insurance available to Owner. In addition to the liability limits available, such insurance will pay on behalf of or will indemnify Owner for defense costs. Any other coverage available to Owner applies on a contingent and excess basis. Such insurance shall include appropriate clauses pursuant to which the insurance companies shall waive its rights of subrogation against Owner.
  4. Design/Builder and any of its subcontractors shall furnish, prior to the start of work, certificates or adequate proof of the foregoing insurance including, if specifically requested by Owner, copies of the endorsements and insurance policies naming Owner as an additional insured, as provided herein. Current certificates of insurance shall be provided prior to the commencement of work and shall be maintained until termination of this Agreement. Design/Builder shall notify Owner in writing, at least thirty (30) calendar days prior to cancellation, or of a material change in any policy.
  5. The certificate holder is included as an additional insured with respect to liability arising out of the named insured's operations performed on behalf of such certificate holder. A waiver of any subrogation endorsement must accompany a certificate of insurance and must include workers' compensation policies.
  6. Carriers providing coverage will be rated by A.M. Best with at least an A-rating and a financial size category of at least Class VII. Such cancellation or material alteration shall not relieve Design/Builder of its continuing obligation to maintain insurance

coverage in accordance with this contract. Carriers shall be licensed in the state(s) where work is performed.

7. If Design/Builder shall fail to procure and maintain such insurance, Owner, upon written notice, may, but shall not be required to, procure and maintain same, but at the expense of Design/Builder. In the alternative, Owner may declare a default hereunder and, unless such default is timely cured, terminate the Agreement. Unless and until the default is cured, neither Design/Builder nor its servants, employees or agents will be allowed to enter upon the Owner's premises.

D. The policies of insurance so required by Paragraph 5.4 shall include as additional insureds the following parties:

1. **California-American Water Company**

### **SC-5.06 Property Insurance**

Add a new paragraph immediately after paragraph 5.06.E which is to read as follows:

- F. The Design/Builder shall bear all risks of all loss or damage to the materials and works until the WORK is finally accepted by the Owner, except that the Design/Builder may claim reimbursement under the Owner's builder's risk insurance policy as herein provided and limited. Owner will carry "All Risk" Builder's Risk Insurance subject to deductibles, terms and conditions as stated in the policy and below with Design/Builder as an additional insured. It is the obligation and responsibility of the Design/Builder to make appropriate claim to the insurance company for all losses claimed under the policy. Should any loss not be covered under this policy, in whole in or parts, the Design/Builder shall bear the loss. Any questions regarding coverages, limitation, exclusion, etc. contained in the policy shall be addressed by bidders prior to submittal of bids, to **Director, Risk Management, American Water, 1025 Laurel Oak Road, Voorhees, NJ 08043, phone 856-310-5926 or email [roger.hammer@amwater.com](mailto:roger.hammer@amwater.com)**

Such insurance shall cover the full value of the cost of replacement to the Owner, less applicable deductibles, of all completed portions of the work to be performed throughout the entire time of construction. The deductibles on each separate and unrelated loss are:

Each claim for loss or damage shall be subject to a per occurrence deductible amount of **\$100,000**, unless a specific deductible shown below applies:

Earth Movement:

(1) **\$100,000** Per Occurrence, except as follows:

(2) **5%** of Total Insurable Values at the time of the loss at each location involved in the loss or damage, subject to a minimum of **\$250,000** any one occurrence, as respects locations in **California and Hawaii**;

(3) **3%** of Total Insurable Values at the time of the loss at each location involved in the loss or damage, subject to a minimum of **\$100,000** any one occurrence, as respects locations in the **New Madrid Earthquake Zone Counties**;

(4) **3%** of Total Insurable Values at the time of the loss at each location involved in the loss or damage, subject to a minimum of **\$100,000** any one occurrence, as respects locations in the **Pacific Northwest Earthquake Zone Counties**;

Flood:

(1) **3%** of Total Insurable Values at the time of the loss at each location involved in the loss or damage, subject to a minimum of **\$500,000** any one occurrence,

(2) **5%** of Total Insurable Values at the time of the loss at each location involved in the loss or damage, subject to a minimum of **\$1,000,000** any one occurrence, as respects locations **wholly or partially within Special Flood Hazard Areas (SFHA), areas of 100-year flooding, as defined by the Federal Emergency Management Agency (FEMA)**;

Wind & Hail:

(1) **2%** of Total Insurable Values at the time of the loss at each location involved in the loss or damage arising out of a **Wind & Hail** (including a storm that has been declared by the National Weather Service to be a Hurricane, Typhoon, Tropical Cyclone, Tropical Storm or Tropical Depression) **except in 1st Tier Counties of AL, GA, VA, MS, NC, SC, LA, TX and the entire states of Hawaii and Florida**, regardless of the number of Coverages, Locations or Perils involved (including but not limited to, all Flood, wind, wind gusts, tornados, cyclones, hail or rain) and subject to a minimum deductible of **\$250,000** any one occurrence;

(2) **5%** of Total Insurable Values at the time of the loss at each location involved in the loss or damage arising out of a **Wind & Hail** (including a storm that has been declared by the National Weather Service to be a Hurricane, Typhoon, Tropical Cyclone, Tropical Storm or Tropical Depression) in **1st Tier Counties of AL, GA, VA, MS, NC, SC, LA, TX and the entire states of Hawaii and Florida**, regardless of the number of Coverages, Locations or Perils involved (including but not limited to, all Flood, wind, wind gusts, storm surges, tornados, cyclones, hail or rain) and subject to a minimum deductible of **\$1,000,000** any one occurrence;

Equipment Breakdown:

(1) **\$100,000** Per Occurrence,

(2) 2 Days per occurrence as respects Soft Costs

If two or more deductible amounts provided in this policy apply to a single occurrence, the total to be deducted shall not exceed the largest deductible applicable unless otherwise stated in the policy.

Such insurance shall not cover (1) damage to or loss of material or equipment furnished by either party which are damaged or lost due to carelessness or negligence on the part of the

Design Builder, or (2) damage to or loss of machinery, tools, equipment, or other property furnished by the Design Builder whether or not used by the Design Builder in carrying out the terms of the Contract unless such machinery, tools, equipment or other property are specifically intended for permanent incorporation into the Contract work and are included in an approved application for payment.

#### **SC-5.07 Waiver of Rights**

Delete the last sentence of paragraph 5.07.A of the General Conditions in its entirety.

#### **SC-6.01 Design Professional Services**

Add the following to Paragraph 6.01 B after Item 7:

8. Upon completion of 60% design, including reconciliation of Owner's comments, the Design/Builder shall develop and present a detailed estimate of the Cost of the Work to the Owner. The estimate shall be prepared and presented in general conformance with the Sixteen (16) Division Format of the Construction Specifications Institute (CSI). The estimate shall identify the following costs as applicable for each area of Work.

- Direct Labor
- Permanent Materials
- Permanent Equipment
- Subcontract Work
- Allowances and Contingencies
- Temporary Construction
- Construction Equipment, Small Tools, Expenditures, etc.
- Permits, Inspections & Testing
- Utility Connections and Utility Usage
- Miscellaneous

Upon review, comment and approval by Owner, this estimate will form the basis for the Target Cost for the project. With the exception of the purchase of long lead equipment or materials as recommended by Design/Builder and approved by Owner, Design/Builder shall not proceed with construction on the project until such time that the approved Target Cost is established.

#### **SC-6.04 Major Materials and Equipment**

Design/Builder shall direct purchase the major materials and equipment for the project. Materials and equipment to be furnished by subcontractors shall be submitted by Design/Builder to Owner for review/comment prior to completion of the Preliminary Design Phase.

#### **SC-6.06 Subcontractors, Suppliers and Others**

Add the following to paragraph 6.06A:



Design/Builder shall include a provision in all Subcontracts, Procurement contracts and Purchase Orders stating that by acceptance of the Subcontract, Procurement Contract or Purchase Order the Subcontractor or Supplier provides advanced consent to the assignment of the Subcontract, Procurement Contract or Purchase Order from the Design/Builder to the Owner if desired by the Owner. Under such assignment Owner will assume all benefits, rights and responsibilities of the Design/Builder.

#### **SC-6.08 Permits**

Delete paragraph 6.08 of the General Conditions in its entirety and insert the following in its place:

A. Unless otherwise provided in the Contract Documents, Design/Builder shall directly or through one or more Subcontractors obtain all necessary permits and licenses. Owner shall pay for all necessary permits and licenses, and assist Design/Builder, when necessary, in obtaining such permits and licenses. Owner shall pay all governmental charges and inspection fees necessary for the prosecution of the Construction. Owner shall pay all charges of utility owners for connections to the Work, and Owner shall pay all charges of such utility owners for capital costs related thereto.

B. The necessary permits are to be investigated by Design/Builder and identified in the Design Memorandum.

Any fees that may be required as a result of resubmittal requirements due to incomplete permit applications prepared by the Design/Builder shall be at the cost of the Design/Builder.

#### **SC-6.10 Taxes**

Add the following language after Paragraph 6.10.A of the General Conditions which is to read as follows:

Design/Builder shall indemnify and hold harmless the Owner for any sales and use tax, which Owner is required to pay by reason of Design/Builder's failure to pay any available Sales and Use Tax.

Owner may set off against monies otherwise due Design/Builder hereunder the amount of any sales and use tax, or any other tax, which Owner is required to pay by reason of Design/Builder's failure to comply with Paragraph 6.07 of the General Conditions.

Design/Builder shall furnish evidence satisfactory to Owner that Design/Builder has paid all sales, consumer, use and other similar taxes required to be paid by Design/Builder. Owner reserves the right to audit the Design/Builder's statement prior to release of retainage and final payment.

#### **SC-8.01 Owner's Responsibility General**

Delete paragraph 8.01.A.6.e in its entirety.

Delete paragraph 8.01.A.6.h in its entirety.

### **SC-8.05 Resident Project Representation**

Add the following after paragraph 8.05 A.

The duties, responsibilities and limitations of authority of the Resident Project Representative shall be as follows:

A. General

The Resident Project Representative (RPR) is Owner's agent at the site, will act as directed by and under the supervision of Owner.

B. Duties and Responsibilities of RPR

1. Conference and Meetings: Attend meetings with Design/Builder, such as preconstruction conferences, progress meetings, job conferences and other project-related meetings.

2. Liaison: Serve as Owner's liaison with Design/Builder working principally through Design/Builder's superintendent and assist in understanding the intent of the Contract Documents; and assist the Owner in serving as liaison with Design/Builder when Design/Builder's operations affect Owner's on-site operations.

3. Shop Drawings and Samples: Advise Owner and Design/Builder of commencement of any Work requiring a Shop Drawing or sample if the submittal has not been approved by Design/Builder's design professional or Owner.

4. Review of Work, Rejection of Defective Work, Inspections and Tests:

a. Conduct on-site observations of the Work in progress to assist Owner in determining if the Work is in general proceeding in accordance with the Contract Documents.

b. Report to Owner whenever RPR believes that any Work is unsatisfactory, faulty or defective or does not conform to the Contract Documents, or has been damaged, or does not meet the requirements of any inspection, test or approval required to be made.

c. Verify that tests, equipment and systems startup and operating and maintenance training are conducted in the presence of appropriate personnel, and that Design/Builder maintains adequate records thereof.

5. Modifications: Consider and evaluate Design/Builder's suggestions for modifications in Drawings or Specifications and report with RPR's recommendations to Owner. Transmit to Design/Builder decisions as issued.

6. Payment Requests: Review applications for payment with Design/Builder for compliance with the established procedure for their submission and forward with recommendations to Owner, noting particularly the relationship of the payment requested to the schedule of values, Work completed and materials and delivered at the site but not incorporated in the Work.

7. Completion:

a. Before Owner issues a certificate of Substantial Completion, submit to Design/Builder a list of observed items requiring completion or correction.

b. Conduct final inspection in the company of Owner and Design/Builder and prepare a final list of items to be completed or corrected.

c. Observe that all items on final list have been completed or corrected and make recommendations to Owner concerning acceptance.

C. Limitations of Authority

Resident Project Representative

1. Shall not authorize any deviation from the Contract Documents or substitution of materials or equipment unless authorized by Owner.

2. Shall not exceed limitations of Owner's authority as set forth in the Agreement or the Contract Documents.

3. Shall not undertake any of the responsibilities of Design/Builder, subcontractors or Design/Builder's superintendent.

4. Shall not issue directions relative to, or assume control over, any aspect of the means, methods or techniques of construction unless such directions or control are specifically required by the Contract Documents.

**SC-10.01 Cost of the Work**

Add the following language immediately after paragraph 10.01.A of the General Conditions:

The Cost of the Work shall include lump sum amounts for Supervision and Superintendence of Construction (including temporary facilities), Design Professional Services for a. Preliminary Design Phase, b. Final Design Phase and c. Construction/operations phase.

The lump sum amount for Supervision and Superintendence of Construction shall include the responsibilities described in General Conditions Article 6.02 and the duties described in General Requirements, Section 1000 - Summary of Work, Paragraph 3.02; Section 1075 – Basis of Payment, Paragraph 1.03; and Section 1500 - Temporary Construction Facilities, Paragraphs 1.01 Water Supply; 1.02 Temporary Heat/Air Conditioning - to include general temporary heating/air conditioning of site office facilities and onsite storage of equipment and materials but not to include permanent heating and air conditioning of plant facilities; 1.03 Electrical Supply - to include temporary electric for site office facilities and that needed to perform construction but not to include permanent power supply and use for testing and start-up of plant facilities and equipment; 1.04 Temporary Lighting- to include temporary lighting of site offices and exterior security lighting but not to include temporary lighting of construction areas; 1.07 Parking - to include parking for supervisory personnel at the site offices but not to include parking areas for construction personnel; 1.08 Progress Cleaning; 1.09 Sanitary Facilities and 1.10 Field Offices. This lump sum shall cover all project supervisory, administrative and engineering personnel costs including salary, payroll labor burden, vehicles, relocation, travel and living expenses. Also included is field office facility complex costs including trailers, office supplies, office equipment, telephone, postage, blueprinting, utilities and miscellaneous. General site facilities furnished by Design/Builder for use by all contractors and subcontractors shall also be included in this lump sum.

The lump sum amounts for Design Professional Services shall include the work described in General Conditions 6.01. as amended by these Supplementary Conditions and work described in the Scope of Design Services including listed attachments.

Add the following language immediately before paragraph 10.01.A of the General Conditions:

**Design/Builder Self Performed Work:** The Design/Builder is eligible to perform Work with its own forces either through a negotiated lump sum price or through successful bidding in competition with qualified subcontractors. No later than completion of the Preliminary Design Phase, the Design/Builder shall notify Owner of specific Work they desire to perform with their own forces either through a negotiated price or as the result of competitive bidding. Design/Builder shall provide justification for Work desired to be performed through a negotiated price. If Owner agrees with the justification, Design/Builder shall provide a firm Lump Sum Proposal with a detailed cost breakdown as backup.

If Owner accepts the proposal, the agreed to price will constitute a lump sum cost to be included in the Cost of the Work. The Design/Builder is responsible for completion of the specified Work in accordance with the Contract Documents including warranty provisions for the price submitted. If Owner rejects the Design/Builder's proposal to self perform specific Work, this Work shall be competitively bid to qualified Subcontractors including the Design/Builder if desired and approved by Owner.

Add the following language at the end of paragraph 10.01.A.2:

To the fullest extent practical, the Design/Builder shall purchase all permanent materials and equipment through documented competitive bidding. Materials and equipment not purchased through competitive bidding shall have prior approval from the Owner.

Add the following language at the end of paragraph 10.01.A.3:

To the fullest extent practical, the Design/Builder shall award all subcontracts through documented competitive bidding. Subcontracts not awarded through competitive bidding shall have prior approval from the Owner.

Add the following language at the end of paragraph 10.01.A.5:

The cost of special consultants shall only be included in the Cost of the Work if they have been authorized by the Owner prior to the furnishing of service.

Add the following language at the end of paragraph 10.01.A.6

The Equipment rental rates to be paid for under a Cost of the Work basis are to be no higher than those prevailing in the locality of the project and shall not exceed 80% of the monthly rental rate determined through proper application of the Equipment Rental Rate Blue Book published by KIII Directory. Monthly operating costs shall be determined by multiplying the blue book estimated hourly operations cost by 120 hours. Prior to using construction equipment owned by Design/Builder or any subsidiary company, provide to Owner a comparison of equipment rental costs between using Design/Builder's equipment versus equipment rented from others.

### **SC-11 Change of Contract Price**

Add the following language immediately before paragraph 11.01 of the General Conditions:

Design/Builder's Fee and provisions for adjustment are provided in the Agreement. In Article 11 of the General Conditions, delete all references to Design/Builder's fee or allowances for overhead and profit. Fee provisions of Article 11 of the General Conditions are applicable to subcontractors performing Work on a Cost of the Work basis per Paragraph 11.01.B.3.

### **SC-12.03 Tests and Inspections**

Add the following language at the end of paragraph 12.03.A of the General Conditions:

All firms and/or inspectors employed by the Design/Builder for the purpose of inspection or testing shall be acceptable to Owner.

### **SC-13.03 Progress Payments**

Amend the second sentence of paragraph 13.03.A.1 of the General Conditions by striking out ten days and inserting twenty days in its place.

### **SC-13.06 Partial Utilization**

SC-13.06.B Add a new paragraph immediately after paragraph 13.06.A.2 of the General Conditions which is to read as follows:

13.06.B. Owner may at any time submit a written request to Design/Builder to permit Owner to take over operation of any such part of the Construction although it is not substantially

complete. Owner and Design/Builder shall make an inspection of that part of the Construction to determine its status of completion and will prepare a list of the items remaining to be completed or corrected thereon before final payment. If Design/Builder does not object in writing to Owner that such part of the Construction is not ready for separate operation by Owner, Owner will finalize the list of items to be completed or corrected and will deliver such list to Design/Builder together with a written division of responsibilities pending final payment between Owner and Design/Builder with respect to security, operation, safety, maintenance, utilities, insurance, warranties and guarantees for that part of the Construction which will become binding upon Owner and Design/Builder at the time when Owner takes over such operation. During such operation and prior to substantial completion of such part of the Construction, Owner shall allow Design/Builder reasonable access to complete or correct items on said list and to complete other related Construction.

### **SC-13.08 Final Application for Payment**

Add the following language at the end of paragraph 13.08 A:

With the final payment request, Design/Builder, Subcontractor and Suppliers shall execute and deliver to the Owner their release of liens on forms supplied by Owner. Blank forms are included in Appendix B of these Supplementary Conditions.

# APPENDIX A

## Limits of Liability Insurance

SC-5.04 Contractor's Liability Insurance is hereby supplemented to include the following:

The limits of liability for insurance required by paragraph GC-5.04 and paragraph SC-5.04 are as follows:

### Insurance Requirements.

1. **Commercial General Liability:**
  - \$1,000,000 per occurrence Combined Single Limits
  - \$1,000,000 General Aggregate
  - \$1,000,000 Products and Completed Operations Aggregate
  - \$1,000,000 Completed Operations-Product Liability
2. **Workers Compensation:**
  - Coverage A: Applicable federal or state requirements: statutory minimum
  - Coverage B: Employer's Liability:
    - Each Accident: \$1,000,000
    - Each Employee-disease: \$1,000,000
    - Policy Limit-disease: \$1,000,000
3. **Automotive Liability**
  - Bodily injury and property damage \$1,000,000 each occurrence combined single limits
4. **Umbrella Liability**
  - \$9,000,000 each occurrence and annual aggregate in excess of Employer's Liability, General Liability and Automotive Liability.
5. **Professional Liability**
  - The Design-Builder shall carry Professional Liability Insurance of \$5,000,000 each claim and in the aggregate covering Design-Builder's liabilities for loss due to error, omission, negligence, mistakes or failure to take appropriate action in the performance of business or professional duties of their employees during the life of the Contract.

<b>ACORD CERTIFICATE OF INSURANCE</b>		ISSUE DATE:			
<b>PRODUCER</b>  <b>VENDOR'S INSURANCE BROKER AND ADDRESS</b>   <hr/> <b>INSURED</b>  <b>VENDOR/CONTRACTOR/TRADE I.A, I.B.</b> <b>Address</b>	THIS CERTIFICATE IS ISSUED AS A MATTER OF INFORMATION ONLY AND CONFERS NO RIGHTS UPON THE CERTIFICATE HOLDER. THIS CERTIFICATE DOES NOT AMEND, EXTEND OR ALTER THE COVERAGE AFFORDED BY THE POLICIES BELOW.				
<b>COMPANIES AFFORDING COVERAGE</b>					
COMPANY LETTER <b>A. ABC INSURANCE COMPANY</b>					
COMPANY LETTER <b>B. XXX INSURANCE COMPANY</b>					
COMPANY LETTER <b>C. YYY INSURANCE COMPANY</b>					
COMPANY LETTER <b>D.</b>					
COMPANY LETTER <b>E</b>					
<b>COVERAGES</b>					
THIS IS TO CERTIFY THAT THE POLICIES OF INSURANCE LISTED BELOW HAVE BEEN ISSUED TO THE INSURED NAMED ABOVE FOR THE POLICY PERIOD INDICATED, NOTWITHSTANDING ANY REQUIREMENT, TERM OR CONDITION OF ANY CONTRACT OR OTHER DOCUMENT WITH RESPECT TO WHICH THIS CERTIFICATE MAY BE ISSUED OR MAY PERTAIN, THE INSURANCE AFFORDED BY THE POLICIES DESCRIBED HEREIN IS SUBJECT TO ALL THE TERMS, EXCLUSIONS AND CONDITIONS OF SUCH POLICIES. LIMITS SHOWN MAY HAVE BEEN REDUCED BY PAID CLAIMS.					
CO LTR	TYPE OF INSURANCE	POLICY NUMBER	POLICY EFFECTIVE DATE (MM/DD/YY)	POLICY EXPIRATION DATE (MM/DD/YY)	LIMITS
A.	<b>GENERAL LIABILITY</b> <input checked="" type="checkbox"/> COMMERCIAL GENERAL LIABILITY <input type="checkbox"/> CLAIMS MADE <input checked="" type="checkbox"/> OCCUR. <input type="checkbox"/> OWNER'S & CONTRACTOR'S PROT. <input checked="" type="checkbox"/> PER PROJECT AGG. <input checked="" type="checkbox"/> CGL FORM #	CGL1234	1/1/2006	1/1/2007	GENERAL AGGREGATE PRODUCTS-COMP/OP AGG. \$ 1,000,000 PERSONAL & ADV. INJURY EACH OCCURRENCE \$ 1,000,000 FIRE DAMAGE (Any one Fire) \$ 1,000,000 MED. EXPENSE (Any one person) \$ 300,000 \$ 10,000
A.	<b>AUTOMOBILE LIABILITY</b> <input checked="" type="checkbox"/> ANY AUTO <input type="checkbox"/> ALL OWNED AUTOS <input type="checkbox"/> SCHEDULED AUTOS <input checked="" type="checkbox"/> HIRED AUTOS <input type="checkbox"/> COMP DED \$500 <input checked="" type="checkbox"/> NON-OWNED AUTOS	AL5678	1/1/2006	1/1/2007	COMBINED SINGLE LIMIT \$ 1,000,000  BODILY INJURY (Per Person) \$  BODILY INJURY (Per Accident) \$  PROPERTY DAMAGE \$
B.	<b>EXCESS LIABILITY</b> <input checked="" type="checkbox"/> UMBRELLA FORM <input type="checkbox"/> OTHER THAN UMBRELLA FORM	XS 9876	1/1/2006	1/1/2007	EACH OCCURRENCE \$9,000,000 AGGREGATE \$9,000,000
A	<b>WORKER'S COMPENSATION AND EMPLOYERS LIABILITY</b>	WC 5432	1/1/2006	1/1/2007	<input checked="" type="checkbox"/> STATUTORY LIMITS EACH ACCIDENT \$1,000,000 DISEASE-POLICY LIMIT \$1,000,000 DISEASE-EACH EMPLOYEE \$1,000,000
	OTHER				Personal Property: \$250,000 Deductible:
<b>DESCRIPTION OF OPERATIONS/LOCATIONS/VEHICLES/SPECIAL ITEMS</b>					
(Reference Project Location or Contract No.) Certificate holder is included as Additional Insured, except for workers compensation, with respect to liability arising out of the named insured's operations as required by written contract. Any coverage afforded to the Additional Insured shall apply as primary and not excess to any other insurance or self insurance available to Additional Insured. Waiver of Subrogation shall apply to all insurance.					
<b>CERTIFICATE HOLDER</b>			<b>CANCELLATION</b>		
_____ American Water Company Address City, State,			SHOULD ANY OF THE ABOVE DESCRIBED POLICIES BE CANCELLED BEFORE THE EXPIRATION DATE THEREOF, THE ISSUING COMPANY WILL MAIL 30 DAYS WRITTEN NOTICE TO THE CERTIFICATE HOLDER NAMED TO THE LEFT, _____ AUTHORIZED REPRESENTATIVE		
ACORD 25-S (7/90)			ACORD CORPORATION 1990		



RELEASE OF LIENS

WHEREAS, we, the undersigned, have installed or furnished labor, materials and/or equipment for the installation of the Project entitled **Design-Build of the Fitch Park ASR Wesll 5 & 6 Above Ground Facilities**, installed pursuant to a written agreement dated \_\_\_\_\_, 20\_\_\_\_, between the **California-American Water**, having an office at 511 Forest Lodge Road, Suite 100, Pacific Grove, CA 93950, hereinafter called Owner and \_\_\_\_\_, having an office at \_\_\_\_\_, hereinafter called Design/Builder, which said facilities are owned by the Owner and described and located as follows:

**Fitch Park ASR Wesll 5 & 6 Above Ground Facilities**  
**Pacific Grove, CA**

WHEREAS, we, the undersigned, have agreed to release any and all claims and liens which we have, or might have, against the Owner, or said facilities by reason of the labor, materials and equipment furnished by us in connection with said installation;

NOW THESE PRESENTS WITNESS that we the undersigned, in consideration of the premises, and of the sum of One Dollar (\$1.00) in hand paid by the said Owner, at and before the sealing and delivery hereof, the receipt whereof we do hereby acknowledge, have remised, released and forever quitclaimed, and by these presents do remise, release and forever quitclaim, unto the said Owner, its successors and assigns, any and all manner of liens, claims and demands whatsoever which we now have, or might or could have, on or against the said facilities, or the owner thereof, for work done, or for equipment or materials furnished in connection with the installation thereof. It is the intent of this release that the Owner, its successors and assigns shall and may hold, have, use and enjoy the said facilities free and discharged from all liens and demands whatsoever which we now have, or might or could have against the same if these presents had not been made.

IN WITNESS WHEREOF, we have hereunto set our hand and seal the day written opposite our signature.

Company Name \_\_\_\_\_ (SEAL)

By \_\_\_\_\_

Title \_\_\_\_\_

Dated \_\_\_\_\_, 20\_\_

Sworn to and subscribed before me,  
a Notary Public, this \_\_\_\_\_ day  
of \_\_\_\_\_, 20\_\_.

\_\_\_\_\_  
Notary Public (SEAL)

I, \_\_\_\_\_, duly authorized representative of \_\_\_\_\_, designated as Design/Builder, do hereby state that the parties whose names are signed to the attached releases, pages 1 through \_\_\_\_\_, are all of the parties who have furnished labor, materials or equipment in connection with the construction of the facilities mentioned above; excepting only such materials as may have been furnished by the Owner.

Dated: \_\_\_\_\_, 20\_\_

\_\_\_\_\_  
Representative's Signature

Sworn to and subscribed before me,  
a Notary Public, this \_\_\_\_\_ day  
of \_\_\_\_\_, 20\_\_.

\_\_\_\_\_  
Notary Public (SEAL)

RELEASE OF LIENS

WHEREAS, we, the undersigned, have installed or furnished labor, materials and/or equipment for the installation of the Project entitled **Fitch Park ASR Wesll 5 & 6 Above Ground Facilities**, installed pursuant to a written agreement dated \_\_\_\_\_, 200\_\_, between the California-American Water, having an office at 511 Forest Lodge Road, Suite 100, Pacific Grove, CA 93950, hereinafter called Owner and \_\_\_\_\_, having an office at \_\_\_\_\_, hereinafter called Design/Builder, which said facilities are owned by the Owner and described and located as follows:

**Fitch Park ASR Wesll 5 & 6 Above Ground Facilities**  
**Pacific Grove, CA**

WHEREAS, we, the undersigned, have agreed to release any and all claims and liens which we have, or might have, against the Owner or said facilities by reason of the labor, materials and equipment furnished by us in connection with said installation;

NOW THESE PRESENTS WITNESS that we, the undersigned, in consideration of the premises, and of the sum of One Dollar (\$1.00) in hand paid by the said Owner, at and before the sealing and delivery hereof, the receipt whereof we, do hereby acknowledge, have remised, released and forever quitclaimed, and by these presents do remise, release and forever quitclaim, unto the said Owner, its successors and assigns, any and all manner of liens, claims and demand whatsoever which we now have, or might or could have, on or against the said facilities, or the owner thereof, for work done, or for equipment or materials furnished in connection with the installation thereof. It is the intent of this release that the Owner, its successors and assigns shall and may hold, have, use and enjoy the said facilities free and discharged from all liens and demands whatsoever which we now have, or might or could have against the same if these presents had not been made. And we do further certify and acknowledge, that we have received of and from the said Design/Builder, payment in full on account of labor done or materials or equipment furnished for or in connection with said facilities.

IN WITNESS WHEREOF, we have hereunto set our hand and seal the day written opposite our signature.

Company Name \_\_\_\_\_ (SEAL)  
By \_\_\_\_\_  
Title \_\_\_\_\_  
Dated \_\_\_\_\_, 20\_\_

Sworn to and subscribed before me, a Notary Public,  
this \_\_\_\_ day of \_\_\_\_\_, 20\_\_\_. \_\_\_\_\_ (SEAL)

**CONDITIONAL WAIVER AND RELEASE ON PROGRESS PAYMENT**

**NOTICE: THIS DOCUMENT WAIVES THE CLAIMANT'S LIEN, STOP PAYMENT NOTICE, AND PAYMENT BOND RIGHTS EFFECTIVE ON RECEIPT OF PAYMENT. A PERSON SHOULD NOT RELY ON THIS DOCUMENT UNLESS SATISFIED THAT THE CLAIMANT HAS RECEIVED PAYMENT.**

---

**Identifying Information**

Name of Claimant:

Name of Customer:

Job Location:

Owner:

Through Date:

---

**Conditional Waiver and Release**

This document waives and releases lien, stop payment notice, and payment bond rights the claimant has for labor and service provided, and equipment and material delivered, to the customer on this job through the Through Date of this document. Rights based upon labor or service provided, or equipment or material delivered, pursuant to a written change order that has been fully executed by the parties prior to the date that this document is signed by the claimant, are waived and released by this document, unless listed as an Exception below. This document is effective only on the claimant's receipt of payment from the financial institution on which the following check is drawn:

Maker of Check:

Amount of Check: \$

Check Payable to:

---

**Exceptions**

This document does not affect any of the following:

- (1) Retentions.
  - (2) Extras for which the claimant has not received payment.
  - (3) The following progress payments for which the claimant has previously given a conditional waiver and release but has not received payment:
    - Date(s) of waiver and release: \_\_\_\_\_
    - Amount(s) of unpaid progress payment(s): \$ \_\_\_\_\_
  - (4) Contract rights, including (A) a right based on rescission, abandonment, or breach of contract, and (B) the right to recover compensation for work not compensated by the payment.
- 

**Signature**

Claimant's Signature:

Claimant's Title:

Date of Signature:

---

**CONDITIONAL WAIVER AND RELEASE ON FINAL PAYMENT**

**NOTICE: THIS DOCUMENT WAIVES THE CLAIMANT'S LIEN, STOP PAYMENT NOTICE, AND PAYMENT BOND RIGHTS EFFECTIVE ON RECEIPT OF PAYMENT. A PERSON SHOULD NOT RELY ON THIS DOCUMENT UNLESS SATISFIED THAT THE CLAIMANT HAS RECEIVED PAYMENT.**

---

**Identifying Information**

Name of Claimant:

Name of Customer:

Job Location:

Owner:

---

**Conditional Waiver and Release**

This document waives and releases lien, stop payment notice, and payment bond rights the claimant has for labor and service provided, and equipment and material delivered, to the customer on this job. Rights based upon labor or service provided, or equipment or material delivered, pursuant to a written change order that has been fully executed by the parties prior to the date that this document is signed by the claimant, are waived and released by this document, unless listed as an Exception below. This document is effective only on the claimant's receipt of payment from the financial institution on which the following check is drawn:

Maker of Check:

Amount of Check: \$

Check Payable to:

---

**Exceptions**

This document does not affect any of the following:  
Disputed claims for extras in the amount of: \$

---

**Signature**

Claimant's Signature:

Claimant's Title:

Date of Signature:

---

## APPENDIX H

### California-American Water Company Fitch Park ASR Well 5 and 6 Above Ground Facilities

#### **DESIGN MEMORANDUM REQUIREMENTS**

The outline provided below identifies the minimum information that must be included in the Design Memorandum. The Design/Builder shall add additional information to the memorandum where appropriate to sufficiently define all critical design parameters so the Owner can understand the Design/Builder's design concept and visualize the final product.

The main section of the Design Memorandum must include project design data which was utilized in the development of drawings and specifications. This would include quantities, capacities, rates, and all other pertinent design criteria for each specific section specified in the Design Scope. A comparison of the required equipment (as calculated or as specified in the Design Scope) to the equipment selected by the Design/Builder is critical such that the Owner can understand the Design/Builder's logic in sizing facilities and selecting equipment. This information must be presented in an organized, easy to read tabular or outline format.

Provide a brief description of the approach for both ASR 5 and 6 Facilities to include

- Process (piping and Instrumentation Diagram)
- Pump and Motor
- Civil/Site Development
- Utility Building/Structures
- Piping and Valves
- Chlorination Facilities

Provide a brief description of the following items for site development

- Layout of the facilities
- Site security
- Site roadways and parking
- Landscaping
- Storm water collection and drainage
- Site utilities

Provide a brief description of the following architectural items

- Structure and Arrangement
- Interior construction – to include room finishes
- Exterior construction

Provide a brief description of the following structural items

- Building structure basis for design
- Design stresses and loading criteria
- Specific geotechnical requirements

Provide a brief description of the following mechanical building systems

- Design criteria
- Plumbing system design

- Sanitary drainage, collection, and treatment systems
- Potable water systems
- Fire Protection
- Heating, ventilation and air conditioning systems

Provide a brief description of the following electrical systems

- General design criteria
- Power distribution functional requirements
- Standby Power
- Lighting requirements
- Telephone communication systems
- Fire Alarm systems
- Lightning protection

Provide a brief description of the following instrumentation and controls systems

- Control system architecture.
- Control philosophy

Along with the above information, the following shall also be included in the Design Memorandum as a minimum.

- a. A hydraulic profile
- b. A process schematic showing all unit processes, points of chemical application, and points of on-line analytical sampling as a minimum.
- c. Chemical feed system schematics
- d. Preliminary drawings showing site and building layouts, sections, and architectural treatment.
- e. Any additional drawings that may further define the facility proposed by the Design/Builder.
- f. An I/O list, functional descriptions, graphic displays, reports, alarm, and historical database definition.
- g. A listing of major equipment required for the project including the manufacturer and model number which will be used as a basis of design. If possible, at least two other alternative manufacturers shall be identified for all major equipment for inclusion in the specifications.
- h. A summary of all permits required for the project and a brief description of the requirements of each. Any permit requirements that need to be completed by the Owner should be identified.
- i. A summary of any significant issues resulting from discussions with utility companies.
- j. A detailed project schedule.

# **American Water Works Service Co., Inc.**

**American Water Engineering**

**Voorhees, NJ**

**Process / Out-Source Design Projects / Network –  
Drawing Standards**



Revision Date: June 20, 2007

## **Table of Contents**

### **AWW Drafting Procedures (Process) ..... PAGE**

#### **Drawing Software ..... 1**

Externally Referenced Drawings (model space) .....1

Layering Convention .....1

File Naming Procedure - XREF Drawings .....2

Contract Drawings.....3

File Naming Procedure (Contract Dwgs) .....5

Text Styles & Dimension Styles .....6

Hatch Patterns.....7

Design Drawing Development Schedule .....8

Water Company No's. ....9

#### **Miscellaneous Procedures**

Addendum Sketches.....9

Working Sketches .....9

Markups (Redlining) for Drawings.....10

#### **Appendices**

Appendix A - Abbreviations .....11

#### **Network Drawing Standards**

Drawing Standards (Network).....15

## Software

1. AutoCad software is the preferred drawing software. The most recent version of AutoCad should be used.

## Drafting Procedures

### EXTERNALLY REFERENCED DRAWING

1. Begin a new drawing with the Awwborder space template file, **AWWBORDER.DWT**.

#### AutoCAD Template Files

<b>FILENAME</b>	<b>DESCRIPTION</b>
AWWMODEL.DWT	This template is to be used for all full-scale (real world) Model Space drafting.

2. Draw all items in real world measurements. Ex: a pipe that is 100 feet long shall be drawn at 100 feet.
3. Save Drawing as per AWW file naming procedure (page 2) for externally referenced drawing using the normal save command icon.

#### Layering Convention

All layer names shall follow the AIA National CAD Standard layering standard. Absolutely **NO** numbers will be used as layer names.

#### Color Scheme

Colors shall determine the line weight of the object being drawn; the color scheme shall be as follows with the first color being the heaviest and the last being the lightest. **CYAN (4), GREEN (3), RED (1), BLUE (5), WHITE (7), YELLOW (2)**. Color **MAGENTA (6)** shall be used for all existing objects. The appropriate color will correspond with the discipline of the dwg. Ex: A concrete foundation will be color (4) Cyan on the structural dwgs but will be color (7) white on the mechanical dwgs for new items. All non specific discipline items will be color (7) white. Text and dimensions shall always be color yellow (2). All bold text shall be color cyan (4). All new hatch patterns will be color 253 on all disciplines except if that item is being described or detailed then you would use a heavier color such as blue or red (new items). The color will be changed on the contract dwg (layout) to agree with the

discipline of that dwg. All discipline driven items shall be color (4) cyan or color (3) green or color (1) red or color (5) blue depending on the complexity of the individual detail and its viewport scale. EX: If a detail shows information regarding a complex steel detail and if cyan was used, the detail bleeds into other items after it was plotted, then you would use color green or red to clearly show the information after it has been plotted. This will be at the user's desecration. Typically, cyan is used for the discipline driven item. All none discipline items will always be color (7) white. All existing items on all disciplines will always be color (6) magenta. The Standard .ctb file will be supplied by AW for plotting to follow the above color scheme.

### File Naming Procedure

#### **Externally Referenced (XREF) Drawings**

Xref drawing files should conform to an eight.three (XXXXXXXXX.DWG) naming structure and should identify the objects being drawn as clearly as possible. The following procedure shall be used to name and save Xref drawings:

<b>First Character</b>	=	X
<b>Second &amp; Third Characters</b>	=	Location/Building Designation AV = Altitude Valve Vault BW = Backwash Tank CB = Chemical Building CW = Clearwell ET = Elevated Tank FB = Filter Building GE = Generator GS = General Site GST = Ground Storage Tank LM=Location Map OF = Office OF = Outfall Structure PS = Pump Station RWI=Raw Water Intake SB = Sed Basin TP=Treatment Plant WW = Washwater Tank
<b>Fourth Character</b>	=	Dash (-)
<b>Fifth Character</b>	=	Discipline code A = Architectural C = Civil/Site work E = Electrical H = HVAC I = Instrumentation M = Mechanical P = Process PL = Plumbing R = Removals S = Structural
<b>Sixth &amp; Seventh Characters</b>	=	Drawing Type

DT = Detail  
 EL = Elevation  
 FP = Floor Plan  
 PR = Profile  
 RP=Roof Plan  
 SC = Section

### Externally Referenced (XREF) Drawings (cont'd)

**Eighth Character** = SH = Schematic  
 = Floor Level or Revision (if necessary, otherwise don't use)  
 Could also be the Section Number (1,2) or Elevation Direction (N, S, E or W)

For Example:

XCB-MFP1.DWG would be the Chemical Building, Mechanical first floor plan.

XAV-SSCA.DWG would be the Altitude Vault, Structural Section "A".

XFB-AE.DWG would be the Filter Building, Architectural Elevation.

### Contract or Sheet Drawings

1. Begin a new drawing with the paper space template file, **AWWBORDER.DWT**. The **AWWBORDER.DWT** shall be used for all disciplines. **The AWWBORDER.dwt shall never be exploded, revised, renamed or scaled. Also, the AWWBORDER.dwt will not be xreferenced into a drawing, a new drawing shall be started each time using the AWWBORDER.dwt.** The limits will remain at **0,0 & 36,24** and be plotted at 1:1. All attributes inside the AWWBORDER.DWT will be filled out according to AWW naming convention for new drawings. AWW uses a document management program and it is **VITAL** that the border template and block remain as is.

#### AutoCAD Template Files

TEMPLATE NAME	DESCRIPTION
AWWBORDER.DWT	This template is to be used for all layouts and annotation in the Paper Space environment. This template is to be used for all drawings slated to be xrefs once the title block information is deleted.

2. Enter necessary information into the AWW title block with DDATTE icon.

3. Save the drawing as per the AWW File Naming Procedure for Contract Drawings. See attached .pdf file.
  4. Toggle to Model Space. Attach the required xref's while on the **G-Anno-Refr** layer.
  5. Toggle back to Paper Space and create all necessary viewports with the MVIEW command while on the Defpoints layer.
  6. All dimensions shall be on the model space of the xref drawing following the Autocad normal standard procedure for dimensions, all other annotation to the drawing shall be on paper space of the contract drawing utilizing the AWW Text and Dimension Styles as defined on page 5.
  7. All contract Dwgs shall be plotted at a scale of 1:1. They will include a graphic scale and north arrow.
  8. The title block shall contain all required pertinent information related to the project such as project title, location, engineer of record, date, WBS number, drawing number, sheet numbers and revision dates. In the case of CAD files the file path shall be placed on the drawing along with the plot date using AutoCAD's plot stamp.
  9. Generally all drawings shall be aligned with project north to the top of the drawing sheet. A north arrow shall be placed on the drawing in a prominent location.
  10. Each drawing shall display project notes in a tabular format when required. Notes shall be project specific as determined by the Project Manager or Designer. Drawing notes shall consist of, but not be limited to, items such as construction/restoration specification, reference map information, utility information etc.
- If the drawing contains topographic information the drawing shall include a vertical datum note, which shall indicated the vertical datum utilized on the plan. It will also include surveyor information. Where a specific horizontal datum is utilized, a horizontal datum note shall be shown on the plan.
11. All drawing revisions made after official release of the drawing shall be dated and noted in the revision block.
  12. All drawings that are issued outside of E&TS shall be updated in the title block as follows:
    - (a) "Preliminary" – used for issue of any drawing prior to approval of Final Design. Drawings issued for permitting purposes shall not be stamped.

- (b) “Permit Set” – used for the issue of any drawing intended for permits.
- (c) “Bid Set” – used for the issue of any drawing intended for bidding.
- (d) “Issued for Construction” – used for issue of any drawing intended for construction.
- (e) “Record Drawing” – used for as-built drawings.

13. Standard survey note shall be added to the topo graphic sheet and read as follows: “All survey information is taken from a survey information is taken from a survey prepared by (name), (city), (state), registered card surveyor, (number #), prepared (date) for (water company)”.

14. All drawing sets shall include cover sheet with drawing index, logo, water co. name, project title, aww engineering name, and month/year.

**IF the contractor uses their own title block/border due to their document management sytem, they shall insert the block named Awwblock.dwg and fill out all attributed information according to the AWW Standarads outside of the contractors border. This will allow the AWW document management tracking to take place.**

## **File Naming Procedure**

### **Contract Dwgs**

- Design contract drawings are assigned numbers, which are based on a 3 to 4 digit company number, a 3 to 4 digit series number and a 2 to 4 digit discipline sheet number (A = Architectural, G = General, E = Electrical, H = HVAC, I = Instrumentation, M = Mechanical, P = Process, PL = Plumbing, R = Removal, S = Structural).

- For Example:

A drawing prepared for New Jersey American Water Company, Lakewood District, and is an Architectural Dwg would be 350-1234-A1, a Mechanical Dwg would be 350-1234-M1. The following sheets in the discipline would be consecutive, M2, M3, M4 etc.

- Drafting personnel in the System Engineering Corporate Office in Voorhees, NJ, assign drawing numbers. A detailed list is kept for all districts within a Water Company. Since all projects are unique, each drawing set must also have a unique number. To avoid any confusion or duplication of drawing numbers, please contact System Engineering for all drawing numbers. Please provide the following information when calling in: Project Name & Station (location), BP Number, Name of Consultant (if one is used), and approximate number of drawings in the

set. System Engineering drafting personnel will then issue a drawing number for the contract drawings and the sequential number for manufacturer's information drawings.

- The project design engineer prior to the start of drafting should prepare a drawing development schedule. The development schedule will provide the title of the project (line 1) and the discipline, location and type of drawing information (lines 2, 3 and 4) required to complete the title block of each drawing. Drawings should be numbered in accordance with this list.

- The electronic drawing filename should conform to an eight or nine.three (XXXXXXXXX.DWG) naming structure and **WILL EQUAL** the AWW drawing number but without the dashes. Call System Engineering Cad Department for numbers (856)-727-6133

- For Example:

A drawing prepared for New Jersey-American Water Company, Lakewood District whose assigned drawing number is 350-1234-A1, would be electronically filed and saved as 3501234A1.DWG.

**IF the contractor uses their own numbering system, all files shall be renamed electronically to follow the AWW standard listed above for final acceptance. The AWW design group will receive a CD containing all electronic drawing files numbered according to the AWW numbering system, including any xrefs, image files and .ctb files.**

The table below lists the standard AWW text styles that are to be used when annotating drawings.

**AutoCAD Text Styles**

<b>TEXT STYLE NAME</b>	<b>FONT</b>	<b>HEIGHT</b>	<b>DESCRIPTION</b>
ROMANS	Roman Simplex	.1	Leaders & Notes & Dimensions
ROMAND	Roman Duplex	.15	Room Names, General Notes Title
ROMANDLG	Roman Duplex	.2	Headings, Titles
STANDARD*	Txt	N/A	Not Used

\*AutoCAD Default Style – not used on AWW drawings.

**AutoCAD Dimension Styles**

Dimensions shall conform to the normal practices as set forth by Autocad for dimensions in model space, xrefs and viewports. All settings within the dimension variables will produce the final size in the viewports, text = .1, text style = Romans, arrow size = .125. Dimension styles shall conform to the following standard: ex: Structural Dimension for a viewport set at 1/4"=1'-0" = S-DIM-48, Architectural Dimension A-DIM-96 for a viewport set at 1/8"=1'-0", this will be repeated for all disciplines and viewports.

## HATCH PATTERNS

### Standard Hatch Patterns

PATTERN	SCALE	ANGLE	DESCRIPTION
Steel			Sections through Steel Members
ANSI-37			Plans & Sections of Block Walls
AR-B816C			Elevations of Block Walls
ANSI-31			Plans of Brick Walls
AR-BRSTD			Sections of Brick Walls
BRICK			Elevations of Brick Walls
AR-CONC			Sections through Concrete
EARTH		<u>45</u>	Grade - New or Existing
INSUL			Sections through Wall Insulation
INSUL			Sections through Roof Insulation (other than batt)
GRATE			Grating - FRP or Aluminum
HOUND			Select fill (under slabs)
AR-SAND			Sand (i.e. Filter Media, Sub-base Material)
Aggregate			Broken Stone (under footers)
Sqshngle			Roof Shingles (elevation view)
Chainlnk			Chain link Fence (elevation view)
Chkdl			Checkered Plate (double line)



PATTERN	SCALE	ANGLE	DESCRIPTION
Chkds			Checkered Plate (single line)

NOTE: Scale of the hatch pattern shall be left up to the cad operator.

## Design Drawing Development Schedule

### AMERICAN WATER SYSTEM ENGINEERING DEPARTMENT IN-HOUSE DESIGN DRAWING DEVELOPMENT SCHEDULE

1ST LINE: PROJECT TITLE AS INDICATED IN BP MEMORANDUM

	2ND LINE	3RD LINE	4TH LINE
GENERAL	COVER SHEET		
CIVIL	CIVIL	LOCATION & VICINITY	PLANS
	CIVIL	SITE WORK & GRADING	PLANS
	CIVIL	SOIL EROSION & SED. CONTROL	PLANS
	CIVIL	SITE WORK	MISCELLANEOUS DETAILS
	CIVIL	OUTSIDE PIPING	PLANS
	CIVIL	OUTSIDE PIPING	PROFILES
REMOVALS	REMOVALS	LIMITS OF CLEARING	PLAN
	REMOVALS	PARTICULAR STRUCTURE	PLANS (at several elevations)
	REMOVALS	PARTICULAR STRUCTURE	SECTIONS
ARCHITECTURAL	ARCHITECTURAL	PARTICULAR STRUCTURE	PLANS (at several elevations)
	ARCHITECTURAL	PARTICULAR STRUCTURE	ELEVATIONS
	ARCHITECTURAL	PARTICULAR STRUCTURE	WALL SECTIONS
	ARCHITECTURAL	PARTICULAR STRUCTURE	DETAILS & SCHEDULES
STRUCTURAL	STRUCTURAL	PARTICULAR STRUCTURE	PLANS (at several elevations)
	STRUCTURAL	PARTICULAR STRUCTURE	SECTIONS
	STRUCTURAL	PARTICULAR STRUCTURE	DETAILS
MECHANICAL	PROCESS	OVERALL PLANT	SCHEMATIC
	PROCESS	OVERALL PLANT	HYDRAULIC PROFILE
	MECHANICAL	INTAKE/PUMP STATION/	PLANS (at several elevations)
	MECHANICAL	INTAKE/PUMP STATION/	SECTIONS
	MECHANICAL	CLARIFIER/FILTER BLDG./	DETAILS
	CHEMICAL PIPING	CLEARWELL/PUMP STATION	SCHEMATICS
	CHEMICAL PIPING	ETC.	PLANS (at several elevations)
	CHEMICAL PIPING	ETC.	SECTIONS & DETAILS
	PLUMBING	ETC.	PLANS
	PLUMBING	ETC.	SECTIONS
	PLUMBING	ETC.	DETAILS
ELECTRICAL	INSTRUMENTATION	OVERALL PLANT	PROCESS & INST. DIAGRAM
	INSTRUMENTATION	OVERALL PLANT	MOUNTING DETAILS
	ELECTRICAL	OVERALL PLANT	LEGENDS

ELECTRICAL  
ELECTRICAL  
ELECTRICAL  
ELECTRICAL  
ELECTRICAL  
ELECTRICAL  
ELECTRICAL  
ELECTRICAL

OVERALL PLANT  
OVERALL PLANT  
OVERALL PLANT  
OVERALL PLANT  
PARTICULAR STRUCTURE  
PARTICULAR STRUCTURE  
PARTICULAR STRUCTURE  
PARTICULAR STRUCTURE

MISCELLANEOUS DETAILS  
SITE PLAN  
ONE LINE DIAGRAM  
SCHEMATIC DIAGRAMS  
PLANS (at several elevations)  
SECTIONS & DETAILS  
CONDUIT SCHEMATIC  
CABLE & CONDUIT SCHEDULE

**NOTES:**

---

**Water Company No's.**  
**Contact AWWSC Engineering for Drawing Prefixes**  
**(856)-346-8282**

**Miscellaneous Procedures**

**Addendum Sketches**

Addendum Sketches are 8 1/2" x 11" (A-size) drawings that are prepared during the bid phase to inform all potential contractors of a change in design. The need for such sketches usually arises during the contractors' review and bid preparation for a project. The Design Engineer for the specific project usually provides input for the Addendum Sketch.

An 8 1/2" x 11" attributed title block has been created and saved as N:\ACADCOM\BORDERS\81-2X11A.DWG and should be inserted **into** a modified or newly prepared plan, section or detail. The size of the sketch has been selected for ease in faxing to the contractors. If a large area of an original drawing is affected by the change/clarification, the entire D-size sheet will be revised and reissued to the all bidding contractors. All clarifying plans, sections or details must also be added to the original bid set of documents for incorporation into the As-built or Record set. Each affected bid set drawing should be updated in a timely manner and the revision should be noted in the Revision block of the title block. Annotation should include: the Addendum number, the drafter's initial, and the current date. Leave space for the approving engineer to initial the revision.

The Addendum Sketch title block contains the following information: Title of Sketch (4 lines), Drafter's Initials, Project Engineer's Initials, Date Sketch was prepared, Project BP Number, Scale of Sketch, Addendum Sketch Number, Sketch Revision Date, and Reference Drawing Number. The Reference Drawing Number is the drawing number of the original design drawing in the bid set where the plan, section or detail was drawn. The Addendum Sketches are assigned drawing numbers in the following format: ADD-001, ADD-002, ADD-003, etc. Senior Drafting Personnel will assign drawing numbers. The original sketch will be filed with the Senior Design Drafter and a copy will be sent to the Approving Engineer for further markup or development.

### **Working Sketches**

Working Sketches are 8 1/2" x 11" (A-size) drawings that are prepared after the project has gone to bid and has been awarded to a contractor. The need for such sketches usually arises during construction and should provide answers to the contractor's questions regarding field changes to the original design. The Design Engineer and/or the Construction Engineer for the specific project usually provide input for the Working Sketch.

An 8 1/2" x 11" attributed titleblock has been created and saved as N:\ACADCOM\BORDERS\81-2X11W.DWG and should be inserted **into** a modified or newly prepared plan, section or detail. The size of the sketch has been selected for ease in faxing to the contractor. If a large area of an original drawing is affected by the change/clarification, the entire D-size sheet will be revised and reissued to the contractor. All clarifying plans, sections or details must also be added to the original bid set of documents for incorporation into the As-built or Record set. Each affected bid set drawing should be updated in a timely manner and the revision should be noted in the Revision block of the title block. Annotation should include: a description of the change, the drafter's initial, and the current date. Leave space for the approving engineer to initial the revision.

The Working Sketch title block contains the following information: Title of Sketch (4 lines), Drafter's Initials, Project Engineer's Initials, Date Sketch was prepared, Project BP Number, Scale of Sketch, Working Sketch Number, Sketch Revision Date, and Reference Drawing Number. The Reference Drawing Number is the drawing number of the original design drawing in the bid set where the plan, section or detail was drawn. The Working Sketches are assigned drawing numbers in the following format: WS-001, WS-002, WS-003, etc. Senior Drafting Personnel will assign drawing numbers. The original sketch will be filed with the Senior Design Drafter and a copy will be sent to the Approving Engineer for further markup or development.

### **Redlining Procedure For Contract Drawings**

Check prints of design contract drawings should be reviewed by the drafting group as well as by the engineering group before they are sent to external agencies for their review,

comments or action. The following should be used as a guideline for redlining these drawings in a concise and consistent manner.

- Red Ink - should be used to indicate all revisions and corrections to a drawing
- Green Ink - should be used to indicate any desired deletions to a drawing
- Yellow Ink - should be used to indicate that any new or revised work has been done correctly
- Blue Ink - should be used by drafting personnel to indicate that a redlined item has been incorporated into the drawing. This will also assist personnel when reviewing the updated check print.
- Pencil - should be used to indicate notes or directions to drafting (things that drafting should do, but not things that should appear on the final drawing - i.e. "Move this electrical cabinet over 3 feet to the right").

## Appendix A AWW Abbreviations

<u>Abbreviation</u>	<u>Description</u>
A.B.	Anchor Bolt
ADJ	Adjacent
ALUM.	Aluminum
ANSI	American National Standards Institute
APPROX.	Approximate
ARCH.	Architectural
AMP	Ampere
ASME	American Society of Mechanical Engineers
ASSY	Assembly
ASTM	American Society for Testing and Materials
UTO.	Automatic
AUX.	Auxiliary
AVG	Average
BLDG	Building
B.O.M.	Bill of Material
B.O.C.	Bottom of concrete
B.O.S.	Bottom of steel
BR	Bronze
BR	Brass
BTM	Bottom
C	Channel
°C	Centigrade, or Celsius
C to C	Center to Center
CFM	Cubic feet per minute

CHKD	Checked/Checkered (as in plate)
CI	Cast Iron pipe
CL.	Clearance
CM	Centimeter
COL.	Column
C.O.	Cleanout
CONC.	Concrete
CONSTR.	Construction
CONT.	Continued
CPLG	Coupling
CU.	Cubic
DEG(°)	Degrees
DIA.	Diameter
D.I.P.	Ductile Iron Pipe
DIM.	Dimension
DISCH.	Discharge
DN	Down
DPI	Differential Pressure Indicator
DWG	Drawing
E	East
EA.	Each
EA	Exhaust Air
E.F.	Each face
EL.	Elevation
ELL	Elbow
EQUIP.	Equipment
E.S.	Each Side
E.W.	Each way
EXIST.	Existing
EXPAN.	Expansion
F	Fan
°F	Fahrenheit
FD	Floor drain
FIG.	Figure
FL.	Floor
FLG	Flange
FLGD	Flanged
FPS	Feet per second
FS	Far side
FT(‘)	Foot or feet
FTG	Fitting
GAL.	Gallon(s)
GALV.	Galvanized
GPM	Gallons per minute
GND	Ground (as in electrical)
H	Height
HB	Hose Bibb

HEX	Hexagon(al)
HORIZ.	Horizontal
HP	Horsepower
HVAC	Heating, ventilation, and air conditioning
HZ	Hertz (frequency)
I.D.	Inside Diameter
IN.(“)	Inches
INV.	Invert (inside bottom of pipe)
JT.	Joint
KG	Kilogram
KVA	Kilovolt amperes
KW	Kilowatts
L	Length
LBS	Pounds
LR	Long Radius (of elbow)
M	Meter
MATL	Material
MAX.	Maximum
MCC	Motor Control Center
MECH.	Mechanical
MFR.	Manufacturer
MH	Manhole
MJ	Mechanical Joint (Pipe)
MIN.	Minimum
MISC.	Miscellaneous
MM	Millimeter
MVA	Megavolt amperes
N	North
N/A	Not applicable
NC.	Normally Closed
N.O.	Normally Open
NO.	Number
NOM.	Nominal
NPS	National pipe size
NPT	National pipe thread
NS	Near Side
NTS	Not to scale
OA	Outside air
O.D.	Outside Diameter
OH	Overhead
OPN’G.	Opening
ORIG.	Original
O.S.D.	Open Site Drain
P&ID	Process & Instrumentation Diagram
PE	Plain End (Pipe, etc.)
PERP.	Perpendicular
PL	Plate

PRESS.	Pressure
PRV	Pressure reducing/regulating valve
PSI	Pound per square inch
PSIA	Pound per square inch absolute
PSIG	Pound per square inch gauge
PVC	Polyvinyl chloride
QTY	Quantity
QUAD.	Quadrant
RED.	Reducing/Reducer
REINF.	Reinforcing/Reinforcement
REQ'D.	Required
REV.	Revision
RPM	Revolutions per minute
S	South
SCH or SCHED.	Schedule
SHT	Sheet
SLV	Sleeve
SQ.	Square
SR	Short Radius (of elbow)
S.S.	Stainless Steel
STD	Standard
STRUCT.	Structure/Structural
SUCT.	Suction
TEMP.	Temperature
THRU	Through
T.O.C.	Top of concrete
T.O.P.	Top of pipe
T.O.S.	Top of steel
TYP.	Typical
UG	Underground
UH	Unit heater
V	Volts
VERT.	Vertical
W	Watts
W	West
W	Width

**MINIMUM STANDARDS FOR DRAWINGS FOR  
DEVELOPER INSTALLED WATER MAIN PACKET**

Three complete sets of design drawings are to be submitted to the Water Company for preliminary review; one set will be returned to the Developer that will include corrections or alterations. One set of final plans signed and sealed by the project engineer and one set of diskettes with the drawings prepared in the Auto CAD version used by the Water Company will then be submitted by the Developer to the Water Company.

1. Design drawings shall be drawn on 24-inch by 36-inch sheets and shall show all water mains and appurtenances (as applicable.) The drawings will have a north arrow and the drawing scale indicated. The acceptable drawing scales are 1" = 20' or 1" = 50'. The name of the subdivision as well as name and address of the Developer and Engineer will be shown on the drawings. Site elevation information will be shown when dictated by site/pipe route topography which will allow adequate assessment of the main being installed. Drawings will show the location, size and type of existing sanitary and storm sewers, storm drains, water mains, culverts, power lines, gas lines and other existing surface structures. Drawings will also illustrate the layout, type and size of proposed utilities and structures such as water mains, sanitary laterals and mains, storm mains, culverts, other drainage structures, street improvements, gas and power lines.
2. Include an overall location and key map for the entire project at a scale not to exceed 1 inch = 200 feet and a vicinity map with a scale not to exceed 1 inch = 2,000 feet.
3. The minimum specific requirements for items shown on water main drawings is as follows:
  - i) R-O-W width and centerline of road.
  - ii) Back of curb with dimension.
  - iii) Dedicated, exclusive or drainage and utility easements.
  - iv) Property lines.
  - v) Length, type, pressure rating of water main must be shown.
  - vi) Location and dimension to main within easement and relative to back of curb and R-O-W.
  - vii) Depth of cover over main.
  - viii) Show all fittings, blow-offs, fire hydrants, valves and other appurtenances along with method of restraint.
4. The Water Company Standard Details for water main construction shall apply.



5. All water mains shall be shown on the drawings and constructed within a dedicated Water Company easement or public right of way. The minimum width of easements required shall be 20 feet. Due to specific site constraints, the Water Company may require wider easements than stated.

# TABLE OF CONTENTS

## TECHNICAL REQUIREMENTS FOR PROJECT (Rev. 1 7.09.18)

<b>PROJECT OVERVIEW &amp; BACKGROUND .....</b>	<b>1</b>
<b>ASR-6 FACILITY .....</b>	<b>2</b>
<i>General.....</i>	<i>2</i>
1.0 Process (Piping and Instrumentation Diagram) .....	3
2.0 Pump and Motor.....	3
3.0 Civil/Site Development.....	4
4.0 Utility Building/Structure.....	
5.0 Piping and valves.....	6
6.0 Electrical.....	
7.0 Controls.....	7
<b>ASR-5 FACILITY .....</b>	<b>11</b>
<i>General.....</i>	<i>11</i>
1.0 Process (Piping and Instrumentation Diagram) .....	12
2.0 Pump & Motor.....	12
3.00 Civil/Site Development.....	13
4.0 Utility Building/Structure.....	14
5.0 Piping and Valves.....	16
6.0 Electrical.....	16
7.0 Controls.....	19
8.0 Chlorination Facilities.....	20
<b>APPENDICES</b>	
APPENDIX 1 PRELIMINARY DESIGN DRAWINGS	
APPENDIX 2 PROJECT TECHNICAL MEMORANDA	
APPENDIX 3 CALAM (CAWC) ELECTRICAL STANDARDS	
APPENDIX 4 PGE INFORMATION	
APPENDIX 5 MISCELLANEOUS INFORMATION	

# **Technical Requirements for Project**

**(Rev. 1 – 7.9.2018)**

## **Project Overview**

The project requires the Design Build firm (D-B) to design and install complete, functional, and operational facilities for two Aquifer Storage and Recovery (ASR) well facilities in Seaside, California; a location map of the project sites is presented in Appendix 1, (Sht. T-1), and Appendix E (Fig. 1). The sites are currently undeveloped easement parcels along the eastern side of General Jim Moore Blvd., immediately west of Ardennes Circle.

## **Background**

The existing Monterey Peninsula ASR system generally consists of four ASR wells located at two separate ASR Facilities. The Santa Margarita (SM) ASR Facility includes the ASR-1 and ASR-2 wells and related facilities (e.g., a common backflush pit, electrical/chemical building, etc.), while the Seaside Middle School (SMS) ASR Facility includes the ASR-3 and ASR-4 wells and related facilities (e.g., an electrical control building). The SMS ASR facility has no backflush pit or chemical injection facilities due to restrictions imposed by the Monterey Peninsula Unified School District (MPUSD) during property negotiations.

The proposed ASR-5 and ASR-6 wells would be part of California American Water Co. (CAWC) larger Monterey Peninsula Water Supply Project, which generally consists of a desalination plant and related facilities, supplemented by expansion of the existing ASR system. The ASR-5 and ASR-6 wells and related facilities are to be located within the Fitch Park base housing area, located on the East side of General Jim Moore (GJM) Blvd. approximately 5,000 feet north of the SM ASR facility.

In addition to the construction of two new ASR wells at the site, various site improvements, utilities, and infrastructure will be needed to effectively utilize the wells; these facilities have been conceptually designed and sized through a separate contract agreement with CAWC.

CAWC has determined that both cost and schedule savings may be achieved by implementing the above-ground facilities development at the

Fitch Park sites as a Design-Build (D-B) type project rather than a conventional Design-Bid-Build (D-B-B) project.

In implementing the project, the D-B will be required to address the following:

- Review and incorporate the basic project features described herein into the project.
- Evaluate and analyze the preliminary design information provided herein and assess the validity and accuracy of the preliminary design with the D-B's proposed project design.
- Incorporate Cal-Am's standard design practices and standard materials/manufacturers into project engineering, final design, and construction.

Specific site background, details, and design requirements for each site are summarized below.

### **ASR-6 Facility**

**General.** The ASR-6 facility shall consist of a dual-purpose injection/extraction well (ASR well) and associated piping and electrical facilities to allow the recharge and recovery of various water sources conveyed to the site. The ASR well shall be constructed by others; however the D-B shall provide site preparation work to allow the mobilization and construction of the well and shall provide post-construction services to incorporate the new well into the site facility.

The ASR-6 facility shall have the following functionality:

- A. Injection of 1,500 gpm of treated, chlorinated potable water from the Cal-Am Distribution system (ie the Carmel River supply system) or from the pending Desal Plant. Recharge water supplies will be conveyed to the site via new transmission pipelines provided by others under separate contract.
- B. Recovery/Production of up to 3,000 gpm from the underlying Santa Margarita Sandstone (Tsm) aquifer system, which may include native

ground water, stored Carmel River water, stored Desal water, or stored purified water from the Pure Water Monterey reclaimed water system. Recovered waters shall be conveyed into the above noted new transmission line installed in the GJM Blvd corridor by others; this water will flow southward to ASR-5 and then to Cal-Am consumers in Monterey. Refer to drawing T-1 for additional details.

- C. ASR well backflushing (aka pump-to-waste) of up to 3,000 gpm for periodic flushing of the well via connection to a new waste pipeline installed in the GJM Blvd corridor by others, which terminates at the backflush/percolation pit at the existing Santa Margarita ASR facility approximately 5,400 ft. south at 1910 GJM Blvd.
- D. Remote monitoring of all facility functions and remote operability of facility via a local PLC at each site and connection to the main Cal-Am SCADA system.

The following sections describe the specific design/engineering constraints associated with the ASR-6 facility.

### **1. Process (Piping and Instrumentation Diagram).**

The general process and instrumentation features required for the facility are shown on sheet I-1 in Appendix 1. This P&ID is similar to the processes at the existing Seaside Middle School (SMS) ASR 3 & 4 facility and the Santa Margarita (SM) ASR 1 & 2 facility. The functionality of the new ASR 6 facility are consistent with the design of the existing ASR sites, Cal-Am desires that the new facilities remain consistent with the piping and operation of all existing Cal-Am ASR facilities. -Therefore, the process piping, valves, and instrumentation should not be changed without consultation and approval from Cal-Am.

### **2. Pump and Motor**

Because the facility wells (ASR-5 & 6) do not yet exist, assumptions were made regarding the performance of the wells to facilitate general equipment sizing and layout. Specific assumptions regarding the well and the Cal-Am system parameters included the following:

- Well specific capacity = 14.6 gpm/ft drawdown\*\*

(\*\* SC basis at 210 days pumping w/40% fouling loss)

- Static water level = 350' b.g.s.
- Additional interference drawdown from adjacent wells = 34'
- Hydraulic grade line of Cal-Am system at sites = 529' elev.

The above parameters yielded an approximate brake horsepower of 750, which was rounded up to a nominal 800 Hp motor sizing based on discussions with Cal Am staff. A Technical Memorandum documenting the well pump sizing (Dated 6-2-17) is included in Appendix 2.

The well pump and motor parameters developed in preliminary design included the following:

- Flow = 3000 gpm @ 792' TDH @ 82% eff.
- Special fabricated steel discharge head, 12" x 12" with internal wet barrel design to allow placement of three 1" sounding tube ports downhole.
- TEFC motor with Inverter Duty windings (480 volt)
- Zincless bronze Alloy C952 impellers and intermediate shaft bearings
- Enclosed tube, water flush tube and shaft design
- 12", X-42 grade column pipe, 550' long, uncoated
- 12x8 Baski "FCV" Downhole Flow Control Valve, set at 500' bgs

### **3. Civil/Site Development**

Civil / site development will need to be implemented in two phases: an initial site clearing and rough grading task to allow mobilization of the well drilling contractor (not a part of the D-B contract) and the second phase of completing all other work after the well driller has demobilized. The existing site is relatively flat and undeveloped, with no existing utilities or infrastructure except for a deep monitoring well located in the Southeast corner of the site. A topographic map showing the site, site boundaries, proposed well location, and preliminary site

improvement design is provided in Appendix 1 – Sheet C-1. The primary civil improvements required at the site include the following:

- General site clearing and rough grading
- Final grading and drainage, with on-site percolation of storm water runoff
- Driveway aprons at GJM Blvd for ingress/egress
- Paving on site for utility and maintenance vehicle access
- Security fencing
- Site access shall be via manually opened double gates secured via padlocks

The following items should be noted in implementing the project:

- The proposed well site location shall not be changed due to the logistical constraints of initial well construction and ongoing well maintenance.
- A Soils Report has not been completed for the facility, and shall be required to be completed by the D-B contractor prior to final facilities design. Soils reports were performed for the extant SM and SMS facilities by Pacific Crest Geotechnical of Watsonville, CA, and were utilized for purposes of the preliminary design work.
- Pavement design shall be for a presumed H-20 load at the facility.

#### **4. Utility Building/Structures**

Preliminary design studies included an Electrical/Controls building to house sensitive equipment. The building conceptual design also incorporated a sound attenuation enclosure for the well to mitigate noise issues associated with well pump operation; the D-B may wish to revisit the benefits of this conjoined concept vs two separate structures. Specific design features of the building included the following:

- The electrical/controls building shall be of Non-combustible CMU construction with concrete plank roof as previously negotiated with Seaside Fire Department to avoid internal building sprinklering.
- The electrical/controls building is envisioned as a UBC Type U building classification
- Mediterranean style architecture similar to existing SMS and SM ASR facilities on GJM Blvd.
- Minimum 380 sq ft interior size, suitable for housing all electrical and control equipment.
- The well pump and motor shall be enclosed within a removable sound attenuation enclosure to mitigate noise from the unit. The enclosure must be fully removable on at least three sides (North, South, and West) to allow maintenance workover rigs to periodically service the well. The enclosure need not be fully enclosing nor must it have a roof, as long as the noise attenuation limits noise to a maximum of 60 dBA at the property (easement) lines at all times. The enclosure must also be designed and/or include features to allow adequate ventilation for the nominal 800 Hp, 480 volt TEFC well pump motor.

Preliminary design work also included the development of an initial Massing Study which conceptualized the well enclosure and electrical building as a single structure; this drawing is included in Appendix 1 as Sheet A-1, but is not a specific design requirement. The D-B may elect to separate the electrical building from the well enclosure or develop a different aesthetic design concept with approval of Cal-Am.

## **5. Piping and Valves**

Piping for the facility has largely been identified in keeping with the P&ID extant for the existing SM and SMS ASR facilities nearby. Preliminary piping plans are provided in Appendix 1 – Sheets G-1 and M-1. Piping specialties are noted on the drawings; the following items are especially noted:



- Remotely controlled valves shall be Cla-Val Co, with Fusion Bonded Epoxy coating in and out, 110 v solenoid operation with manual override on the solenoid, stainless steel trim, indicating limit switches for fully open and closed positions, pilot strainers, opening and closing speed control valves, and isolation cocks.
- Flow meters shall be Sparling 656 Tigermag magnetic flowmeters, with local display plus remote transmission 4-20 mA output, polyurethane liner, and bidirectional rate and bidirectional totalizing functions.
- Aboveground piping spools shall be standard weight carbon steel, Class 125 flanges, fusion-bonded epoxy coated in and out, and 1" thread-o-let ports located 6" from the flange face for each spool.
- Water flush lube system for the well pump shall include both real time flow measurement and lube line filter differential pressure instrumentation; both with Interlock Shutdown of the well pump upon loss of flow or pressure in the lube line.

Additional information is provided on the piping drawings G-1, and M-1, and the P&ID (Sheet I-1), both in Appendix 3.

## **6. Electrical**

Electrical design and installation shall be implemented in accordance with the following American Water design criteria, standards and applicable codes:

- *3.1: "Recommended Electrical Design Criteria and Standards"*
- *3.2: "Power System Study and Arc Flash Analysis Requirements Version Date: March 2018"*
- *3.3: "Acceptable Electrical Equipment Manufacturers and Suppliers, March 2018"*
- *3.4: "SEL Devices Monitoring Points (Modbus to SCADA /RTU)"*
  - Note: Cal Am has agreed to the following exceptions to the above standards:

- LED lighting shall be used in all areas of the facilities.

The standards and attachments are in Appendix 3

- California Electrical Code – Latest Edition

The 800 HP Rated Vertical Motor is based on the pump sizing discussed in Item 2 above. The design basis is for the 800 HP motors to have a voltage rating of 460 volts, for use on a 480V system. This voltage rating was chosen primarily due to the need for portable emergency generator backup power at the site. See “Electrical Service Alternatives” Technical Memorandum (TM), 7-27-17 in Appendix 2.

An indoor NEMA 1G Variable Frequency Drive (VFD) will be used to feed the 800 HP Well Pump Motors. The VFD allows speed/flow adjustment of the pump during production and flushing of the well and limits the motor starting voltage drop to meet PG&E requirements. The VFD shall have the following general specifications:

- 18-pulse width modulation (PWM) drive unit
- No VFD bypass
- Heavy-Duty service (50 C vs standard 40 C temperature rating)
- dV/dT output filter
- Allen Bradley is an acceptable VFD supplier for low voltage VFD’s.

The one-line (single-line) diagram design is based on using an Allen Bradley Power Flex 755.

Auxiliary electrical loads such as building heating, ventilation and air conditioning (HVAC) and miscellaneous pumps shall be fed from 480-volt motor control centers or switchboards.

Per CAWC electrical design criteria and standards, the air conditioning units shall be provided with an economizer mode which uses outside air as the first stage and be designed to withdraw heat from above the VFD exhaust vents and introduce cooling air near the VFD air intakes.

Lighting and convenience receptacles will be fed from 208V/120V transformers and lighting panels.

### **System Loading and PG&E Electrical Service:**

ASR-5 and ASR-6 well pumps shall have separate electrical services from PG&E. The basis for this decision is detailed in "Electrical Service Alternatives" TM, 7-27-17 in Appendix 2.

Each pump station system NEC calculated full-load amperage (F.L.A.) is 1282 amperes, which includes well pump, and the miscellaneous auxiliary loads, as shown in the Table "MSB & Feeder Load Schedule" on Drawing E-1. The panel has been sized as a 1600-ampere meter/main service panel. This size panel is larger than required but allows for consistency in equipment size with ASR-5. Final size to be determined in detailed design.

PG&E has indicated the PG&E transformers will probably each be a 1500 kVA unit. The pad-mounted transformer will be located near each of the electrical buildings and be fed from service drops from the 12 kV overhead line passing by the site on General Jim Moore Boulevard. See Drawings G-1, and G-2 in Appendix 1. Final location of the transformer depends on configuration of the electrical room and final discussions with PG&E.

The PG&E contact information, Application Number and system short circuit data for the facility is in Appendix 4. The short circuit data shall be used to perform the power system studies required by the "Power System Study and Arc Flash Analysis Requirements: Reviewed March 2018" in Appendix 3.

The preliminary electrical One Line Diagram (O.L.D) and Load Schedule for the ASR-6 facility is presented on Drawing E-1 in Appendix 1.

Layout for the major electrical equipment are shown on Drawing E-2 in Appendix 1

## **7. Controls**

The facility controls shall be similar in scope and configuration to the existing SM and SMS facilities. The primary functions of the control system shall:

- Allow start/stop of the well pump
- Allow speed adjustment of the well pump in various operational modes, based of flow or pressure setpoint, or manual adjustment
- Allow actuation of the process Clavalves
- Provide alarm, warning, and shutdown interlock functions
- Record and store process operational data
- Communicate with main Cal-Am SCADA system

The control system shall also include a Local Control Panel (LCP) proximate to the well pump to allow operators to start, stop, and control the various Cla-Val valves during transitional operations of well backflushing and injection. A TM (Dated 6-2-17) discussing the various controls and the P&ID (I-1) is provided in Appendix 2.

The PLC shall have enough input and output capacity for the existing instrumentation and controls plus approximately ten percent spare analog and digital inputs and outputs.

A local Operator Interface Panel (OIP) shall be provided on the front of the control panel. The PLC program and OIP screens will be programmed to control the pumps and show the new booster and well pump operation, status and alarms, indicated above and on the P&ID.

The PLC shall communicate to Cal Am's central office by cellular modem. All signals shown on the P&ID shall be transmitted.

New SCADA screens shall be developed and loaded into the system to display the pump/facilities operation at Cal Am's office.

PLC and SCADA programming and equipment shall be consistent with the existing SM and SMS facilities.

Differential pressure and pressure transmitters shall be heat traced and mounted inside O'Brien instrument enclosures. All transmitter tubing shall be heat traced.

### **ASR-5 Facility**

**General.** The ASR-5 facility shall consist of a dual-purpose injection/extraction well (ASR well) and associated piping and electrical facilities to allow the recharge and recovery of various water sources conveyed to the site. The ASR well shall be constructed by others; however the D-B shall provide site preparation work to allow the mobilization and construction of the well and shall provide post-construction services to incorporate the new well into the site facility.

The ASR-5 facility shall have the following functionality:

- A. Injection of 1,500 gpm of treated, chlorinated potable water from the Cal-Am Distribution system (ie the Carmel River supply system) or from the pending Desal Plant. Recharge water supplies will be conveyed to the site via new transmission pipelines provided by others under separate contract.
- B. Recovery/Production of up to 3,000 gpm from the underlying Santa Margarita Sandstone (Tsm) aquifer system, which may include native ground water, stored Carmel River water, stored Desal water, or stored purified water from the Pure Water Monterey reclaimed water system. Recovered waters shall be conveyed into the above noted new transmission line installed in the GJM Blvd corridor by others, proceeding southwards to Cal-Am consumers in Monterey.
- C. ASR well backflushing (aka pump-to-waste) of up to 3,000 gpm for periodic flushing of the well via connection to a new waste pipeline installed in the GJM Blvd corridor by others, which terminates at the backflush/percolation pit at the existing Santa Margarita ASR facility approximately 4,800 ft. south at 1910 GJM Blvd.
- D. Remote monitoring of all facility functions and remote operability of facility via a local PLC at each site and connection to the main Cal-Am SCADA system.

- E. Chlorination facility to allow 12.5% sodium hypochlorite solution for disinfection of produced waters from both the ASR-5 and ASR-6 facilities prior to their conveyance south to Cal-Am consumers.

The following sections describe the specific design/engineering constraints associated with the ASR-5 facility.

### **1. Process (Piping and Instrumentation Diagram).**

The general process and instrumentation features required for the facility are shown on sheet I-1 in Appendix 1. This P&ID is similar to the processes at the existing Seaside Middle School (SMS) ASR 3 & 4 facility and the Santa Margarita (SM) ASR 1 & 2 facility. Because these facilities and process piping have been found to be satisfactory for the existing sites – and because it is desired to keep the piping and operation of all Cal-Am ASR facilities consistent - the process piping and instrumentation should not be changed without consultation and approval from Cal-Am. *Note that the P&ID does not show the Chlorination system required at the ASR-5 facility; the D-B shall develop a P&ID for these facilities as part of the design work for the project. Further discussion of the Chlorination facilities requirements is provided in section 8 below.*

### **2. Pump and Motor**

Because the facility wells (ASR-5 & 6) do not yet exist, assumptions were made regarding the performance of the wells to facilitate general equipment sizing and layout. Specific assumptions regarding the well and the Cal-Am system parameters included the following:

Because the facility wells (ASR-5 & 6) do not yet exist, assumptions were made regarding the performance of the wells to facilitate general equipment sizing and layout. Specific assumptions regarding the well and the Cal-Am system parameters included the following:

- Well specific capacity = 14.6 gpm/ft drawdown\*\*  
(\*\* SC basis at 210 days pumping w/40% fouling loss)
- Static water level = 350' b.g.s.
- Additional interference drawdown from adjacent wells = 34'

- Hydraulic grade line of Cal-Am system at sites = 529' elev.

The above parameters yielded an approximate brake horsepower of 750, which was rounded up to a nominal 800 Hp motor sizing based on discussions with Cal Am staff. A Technical Memorandum documenting the well pump sizing (Dated 6-2-17) is included in Appendix 2.

The well pump and motor parameters developed in preliminary design included the following:

- Flow = 3000 gpm @ 792' TDH @ 82% eff.
- Special fabricated steel discharge head, 12" x 12" with internal wet barrel design to allow placement of three 1" sounding tube ports downhole.
- TEFC motor with Inverter Duty windings (480 volt)
- Zincless bronze Alloy C952 impellers and intermediate shaft bearings
- Enclosed tube, water flush tube and shaft design
- 12", X-42 grade column pipe, 550' long, uncoated
- 12x8 Baski "FCV" Downhole Flow Control Valve, set at 500' bgs

### **3. Civil/Site Development**

Civil / site development will need to be implemented in two phases: an initial site clearing and rough grading task to allow mobilization of the well drilling contractor (not a part of the D-B contract) and the second phase of completing all other work after the well driller has demobilized. The existing site is relatively flat and undeveloped, with no existing utilities or infrastructure except for a deep monitoring well located in the Southeast corner of the site. A topographic map showing the site, site boundaries, proposed well location, and preliminary site improvement design is provided in Appendix 1 – Sheet C-2. The primary civil improvements required at the site include the following:

- General site clearing and rough grading

- Final grading and drainage, with on-site percolation of storm water runoff
- Driveway aprons at GJM Blvd for ingress/egress
- Paving on site for utility and maintenance vehicle access
- Security fencing
- Site access shall be via manually opened double gates secured via padlocks
- Abandonment of existing Storm Drain drop inlet on western edge of easement

The following items should be noted in implementing the project:

- The proposed well site location shall not be changed due to the logistical constraints of initial well construction and ongoing well maintenance.
- A Soils report has not been completed for the facility, and shall be required to be completed by the D-B prior to final facilities design. Soils reports were performed for the extant SM and SMS facilities by Pacific Crest Geotechnical of Watsonville, CA, and were utilized for purposes of the preliminary design work.
- Pavement design shall be for a presumed H-20 load at the facility.

#### **4. Utility Building/Structures**

Preliminary design studies included an Electrical/Controls building to house sensitive equipment, and a Chlorination room to house chemical storage and dispensing equipment. The building conceptual design also incorporated a sound attenuation enclosure for the well to mitigate noise issues associated with well pump operation; the D-B may wish to revisit the benefits of this conjoined concept vs two separate structures. Specific design features of the building included the following:



- The electrical/controls building shall be of Non-combustible CMU construction with concrete plank roof as negotiated with Seaside Fire Department to avoid internal building sprinklering.
- The electrical/controls building is envisioned as a UBC Type U building classification
- Mediterranean style architecture similar to existing SMS and SM ASR facilities on GJM Blvd.
- Minimum 380 sq ft interior size, suitable for housing all electrical and control equipment. The preliminary estimation of the Chlorination room is approximately 900 sq ft.
- The well pump and motor shall be enclosed within a removable sound attenuation enclosure to mitigate noise from the unit. The enclosure must be fully removable on at least three sides (North, South, and West) to allow maintenance workover rigs to periodically service the well. The enclosure need not be fully enclosing nor must it have a roof, as long as the noise attenuation limits noise to a maximum of 60 dBA at the property (easement) lines at all times. The enclosure must be designed and/or include features to allow adequate ventilation for the nominal 800 Hp, 480 volt TEFC well pump motor.

Preliminary design work also included the development of an initial Massing Study which conceptualized the well enclosure, electrical building, and Chlorination room as a single structure; this drawing is included in Appendix 1 as Sheet A-2, but is not a specific design requirement. The D-B may elect to separate the electrical building and/or Chlorination room from the well enclosure or develop a different design concept with approval of Cal-Am.

*Note that this Massing Study considered the inclusion of a chlorination room as part of the facility layout. This conceptual layout is provided for informational purposes and may be modified with the approval of Cal-Am. Further discussion of the Chlorination facilities is provided in Section 8 below.*

## 5. Piping and Valves

Piping for the facility has largely been identified in keeping with the P&ID extant for the existing SM and SMS ASR facilities nearby. Preliminary piping plans are provided in Appendix 1 – Sheets G-2 and M-2. Piping specialties are noted on the drawings; the following items are especially noted:

- Remotely controlled valves shall be Cla-Val Co, with Fusion Bonded Epoxy coating in and out, 110 v solenoid operation with manual override on the solenoid, stainless steel trim, indicating limit switches for fully open and closed positions, pilot strainers, opening and closing speed control valves, and isolation cocks.
- Flow meters shall be Sparling 656 Tigermag magnetic flowmeters, with local display plus remote transmission 4-20 mA output, polyurethane liner, and bidirectional rate and bidirectional totalizing functions.
- Aboveground piping spools shall be standard weight carbon steel, Class 125 flanges, fusion-bonded epoxy coated in and out, and 1" thread-o-let ports located 6" from the flange face for each spool.
- The piping drawing does not show or detail the Chlorination injection piping, which is required to disinfect production from both ASR-5 and ASR-6. The D-B shall address this feature in their updated design drawings.

## 6. Electrical

Electrical design and installation shall be implemented in accordance with the following American Water design standards and applicable codes:

- 3.1: "*Recommended Electrical Design Criteria and Standards*" with
- 3.2: "*Power System Study and Arc Flash Analysis Requirements Version Date: July 2017*"
- 3.3: "*Acceptable Electrical Equipment Manufacturers and Suppliers*"
- 3.4: "*SEL Device Monitoring Points (Modbus to SCADA RTU)*"

- Note: Cal Am has agreed to the following exceptions to the above standards:
  - LED lighting shall be used in all areas of the facilities.

The American Water criteria and standards are in Appendix 3

- California Electrical Code – Latest Edition

The 800 HP Rated Vertical Motor is based on the pump sizing discussed in Item 2 above. The design basis is for the 800 HP motors to have a voltage rating of 460 volts, for use on a 480V system. This voltage rating was chosen primarily due to the need for portable emergency generator backup power at the site. See "Electrical Service Alternatives" Technical Memorandum (TM), 7-27-17 in Appendix 2.

An indoor NEMA 1G Variable Frequency Drive (VFD) will be used to feed the 800 HP Well Pump Motors. The VFD allows speed/flow adjustment of the pump during production and flushing of the well and also limits the motor starting voltage drop to meet PG&E requirements. The VFD shall have the following general specifications:

- 18-pulse unit
- No VFD bypass
- Heavy-Duty service (50 C vs standard 40 C temperature rating)
- dV/dT output filter
- Allen Bradley is an acceptable VFD supplier for low voltage VFD's.

The One Line design is based on using an Allen Bradley Power Flex 755.

Auxiliary electrical loads such as building heating, ventilation and air conditioning (HVAC) and miscellaneous pumps shall be fed from 480-volt motor control centers or switchboards.

Per Cal Am's Electrical Design Criteria, the air conditioning units shall be provided with an economizer mode which uses outside air as the first

stage and be designed to withdraw heat from above the VFD exhaust vents and introduce cooling air near the VFD air intakes.

Lighting and convenience receptacles will be fed from 208V/120V transformers and lighting panels.

### **System Loading and PG&E Electrical Service:**

ASR-5 shall have separate electrical services from PG&E. The basis for this decision is detailed in "Electrical Service Alternatives" TM, 7-27-17 in Appendix 2.

The well pump will operate continuously for a total system NEC calculated load of 1282 amperes, including the preliminary miscellaneous auxiliary loads, as shown in the Table below. The panel has been sized as a 1600-ampere meter/main service panel. This size panel is large enough to supply the anticipated loads shown, as well as the chemical storage and dispensing building loads, to be determined in detailed design.

PG&E has indicated the PG&E transformer will probably be a 1500 kVA unit. The pad-mounted transformer will be located near the electrical building and be fed from a service drop from the 12 kV overhead line passing by the site on General Jim Moore Boulevard. See Drawing G-2 in Appendix 1.

The layout plan shows the preliminary location of the transformer. Final location will depend on configuration of the electrical room and final discussions with PG&E.

The PG&E contact information, Application Number and system short circuit data for the facility is in Appendix 4. The short circuit data shall be used to perform the power system studies required by the "Power System Study and Arc Flash Analysis Requirements, Reviewed March 2018" in Appendix 3.

The preliminary electrical One Line Diagram and Load Schedule for the ASR-6 facility is presented on Drawing E-3 in Appendix 1.

Layouts for the major electrical equipment are shown on Drawing E-4 in Appendix 1.

## **7. Controls**

The facility controls shall be similar in scope and configuration to the existing SM and SMS facilities, with the exception of the addition of disinfection of the ASR-5 and ASR-6 well production. The primary functions of the control system shall:

- Allow start/stop of the well pump
- Allow speed adjustment of the well pump in various operational modes, based of flow or pressure setpoint, or manual adjustment
- Allow actuation of the process Clavalves
- Provide alarm, warning, and shutdown interlock functions
- Record and store process operational data
- Communicate with main Cal-Am SCADA system

The control system shall also include a Local Control Panel (LCP) proximate to the well pump to allow operators to start, stop, and control the various Clavalves during transitional operations of well backflushing and injection. A TM (Dated 6-2-17) discussing the various controls and the P&ID (I-1) is provided in Appendix 2.

The PLC shall have enough input and output capacity for the existing instrumentation and controls plus approximately ten percent spare analog and digital inputs and outputs.

A local Operator Interface Panel (OIP) shall be provided on the front of the control panel. The PLC program and OIP screens will be programmed to control the pumps and show the new booster and well pump operation, status and alarms, indicated above and on the P&ID.

The PLC shall communicate to Cal Am's central office by radio modem. All signals shown on the P&ID shall be transmitted.

New SCADA screens shall be developed and loaded into the SCADA system to display the new pump/facility operation at Cal Am's office.

PLC and SCADA programming and equipment shall be consistent with the existing SM and SMS facilities.

Differential pressure and pressure transmitters shall be heat traced and mounted inside O'Brien instrument enclosures. All transmitter tubing shall be heat traced. *Note that the P&ID does not show the Chlorination system required at the ASR-5 facility; the D-B shall develop a P&ID for these facilities as part of the design work for the project. Further discussion of the Chlorination facilities requirements is provided in section 8 below.*

## **8. Chlorination Facilities**

In addition to the features and equipment of the ASR-6 facility, the ASR-5 site shall also include a Chlorination facility to disinfect produced waters from both ASR-5 and ASR-6 as they are conveyed southward to Cal-Am consumers.

Because the ASR wells have not been constructed, precise water quality information (including Chlorine Demand) is not available. For purposes of planning and preliminary design, water quality was assumed to include a Chlorine Demand of 0.75 mg/L, and a desired free Chlorine residual into the Cal-Am conveyance system of 1.5 mg/L, for a total dose of 2.25 mg/L. The D-B will need to address the current uncertainty in water quality and well performance in the design process. An estimate of the Chlorine dosing needs for the facility (dated 9-26-17) and a TM addressing the preliminary design issues for chlorination (dated 10-4-17) are included in Appendix 2.

The Chlorination facility shall have the following features:

- Dosing of up to 3 mg/L max (2.25 mg/L design) sodium hypochlorite 12.5% solution.
- Storage for 30 days supply of bulk delivered hypochlorite on site.
- Double containment for all chemical storage and dispensing equipment.

- Chemical offloading facilities to accommodate bulk hypochlorite delivery, including an offloading/washdown pad sized for a WB-50 / 5,000 gallon tanker truck vehicle.
- Compressed air supply to pressurize truck and offload chemical.
- Redundant day tanks and transfer pumps.
- Bulk storage tank level indication and vent scrubber.
- Redundant chemical injection quills and injection ports with static mixers for hypochlorite injection.
- Chemical room temperature control to prevent solution freezing and heat degradation.
- Safety showers, Eyewash stations, Chemical spill containment equipment, and related chemical safety features and equipment.





**Appendix 1**  
**Preliminary Design Drawings**

T-1: Title Sheet & Facility Map

I-1: Piping & instrumentation Diagram: ASR-5 & 6

G-1: ASR-6 Site

C-1: ASR-6 General Site Layout

M-1: ASR-6 Site Mechanical Plan

A-1: ASR-6 Architectural Mass Study

E-1: ASR-6 Electrical One Line Diagram

E-2: ASR-6 Building Electrical Layout

G-2: ASR-5 Site

C-2: ASR-5 General Site Layout

M-2: ASR-5 Site Mechanical Plan

A-2: ASR-5 Architectural Mass Study

E-3: ASR-5 Electrical One Line Diagram

E-4: ASR-5 Building Electrical Layout



**DRAWING LIST**

- T-1 TITLE SHEET & FACILITY MAP,  
FITCH PARK ASR #5 & #6
- I-1 PIPING & INSTRUMENT DIAGRAM,  
FITCH PARK ASR #5 & #6
- G-1 GENERAL SITE LAYOUT,  
FITCH PARK ASR #6
- M-1 MECHANICAL PLAN,  
FITCH PARK ASR #6
- A-1 ARCHITECTURAL MASS STUDY,  
FITCH PARK ASR #6
- E-1 ONE LINE DIAGRAM,  
FITCH PARK ASR #6
- E-2 BUILDING ELECTRICAL LAYOUT,  
FITCH PARK ASR #6
- G-2 GENERAL SITE LAYOUT,  
FITCH PARK ASR #5
- M-2 MECHANICAL PLAN,  
FITCH PARK ASR #5
- A-2 ARCHITECTURAL MASS STUDY,  
FITCH PARK ASR #5
- E-3 ONE LINE DIAGRAM,  
FITCH PARK ASR #5
- E-4 BUILDING ELECTRICAL LAYOUT,  
FITCH PARK ASR #5

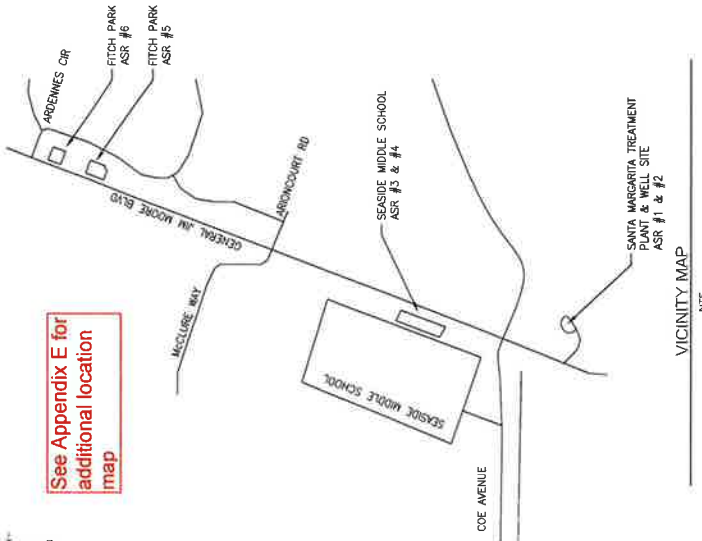

**BLOCK DIAGRAM - MONTEREY PENINSULA WATER PROJECTS**

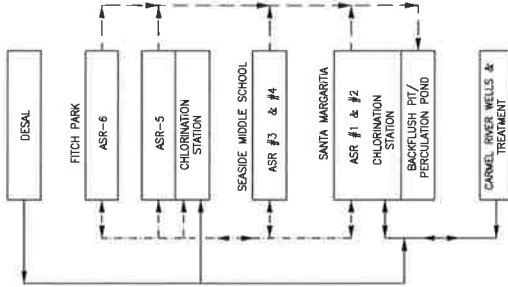

GENERAL JIM MOORE BLVD



**VICINITY MAP**  
NTS



**FITCH PARK ASR #6**

**FITCH PARK ASR #5**

**FACILITY MAP**

SCALE: 1"=40'-0"



REV	DATE	BY	DESCRIPTION

DESIGNED 1/21  
DRAWN  
CHECKED

**WARNING**  
IF THIS SEAL DOES NOT MEASURE 1" THEN DRAWING IS NOT TO SCALE

**UNAUTHORIZED CHANGES & USES CAUTION:**  
The engineer preparing these plans will not be responsible for any errors or omissions or for any changes to or uses of these plans. All changes to the plans must be in writing and must be approved by the preparer of these plans.

California American Water  
511 Forest Lodge Rd,  
Suite 100  
Pacific Grove, CA 9350



**TITLE SHEET & FACILITY MAP**  
**FITCH PARK ASR #5 & #6**  
FITCH PARK ASR DESIGN-BUILD PROJECT  
CALIFORNIA AMERICAN WATER CO.

PROJECT NO.  
T-1

SCADA  
BY CAL-AM

ALL SIGNALS ARE RELATED TO SCADA

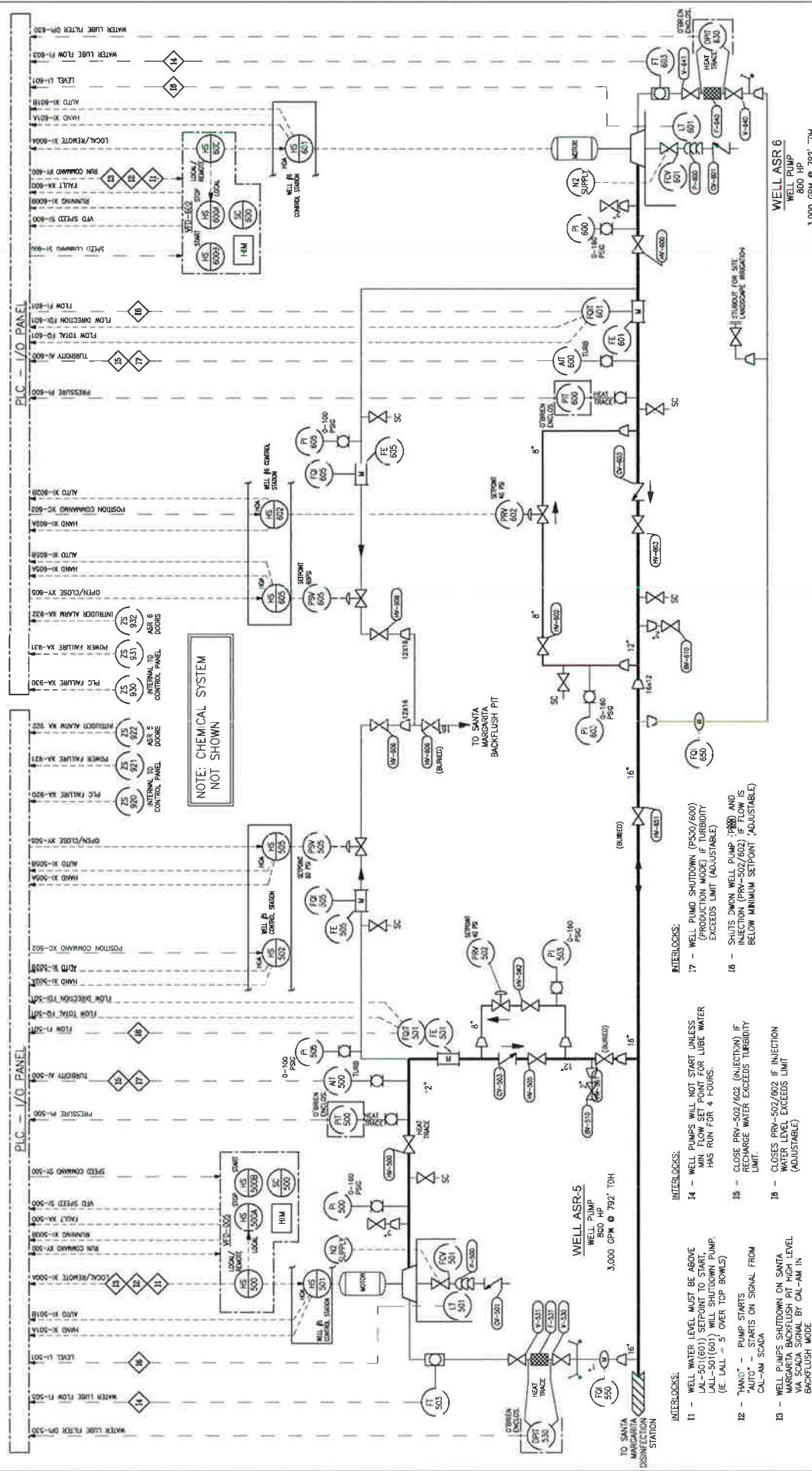

WELL ASR 6  
WELL PUMP  
800 GPM  
3,000 GPM @ 792' TDH

WELL ASR 5  
WELL PUMP  
500 GPM  
3,000 GPM @ 792' TDH

- INTERLOCKS:**
- 11 - WELL WATER LEVEL MUST BE ABOVE LALL-500 (600) SHALL SHUTDOWN PUMP. (E. LALL = 3' OVER TOP BOWLS)
  - 12 - "HAND" - PUMP STARTS "AUTO" - STARTS ON SIGNAL FROM CAL-AM SCADA
  - 13 - WELL PUMPS SHUTDOWN ON SANTA MARGARITA BACKFLUSH PIT HIGH LEVEL AND WELLS SHUTDOWN BY CAL-AM IN BACKFLUSH MODE
- INTERLOCKS:**
- 14 - WELL PUMPS WILL NOT START UNLESS PUMP OPERATING FOR LUBE WATER HAS RUN FOR 4 HOURS.
  - 15 - CLOSE PRV-502/602 (INJECTION) IF RECHARGE WATER EXCEEDS TURBIDITY LIMIT.
  - 16 - CLOSE PRV-502/602 IF INJECTION WATER LEVEL EXCEEDS LIMIT (ADJUSTABLE)
- INTERLOCKS:**
- 17 - WELL PUMP SHUTDOWN (PS30/600) (PRODUCTION MODE) IF TURBIDITY EXCEEDS LIMIT (ADJUSTABLE).
  - 18 - SHUTS DOWN WELL PUMP (PRV) AND INJECTION (PRV-502/602) IF FLOW IS BELOW MINIMUM SETPOINT (ADJUSTABLE)

REV	DATE	BY	DESCRIPTION

DESIGNED 1/2	
DRAWN	
CHECKED	

WARNING	

UNAUTHORIZED CHANGES & USES CAUTION:	
The engineer preparing these plans will not be responsible for, or liable for, unauthorized alterations to the plans unless specifically approved by the preparer of these plans.	

California American Water	511 Forest Lodge Rd, Suite 100 Pacific Grove, CA 93950
---------------------------	--------------------------------------------------------------

  

CALIFORNIA AMERICAN WATER
---------------------------

PROJECT NO.	

**PIPING & INSTRUMENT DIAGRAM**  
**FITCH PARK SITE ASR #5 & #6**  
**FITCH PARK ASR DESIGN-BUILD PROJECT**  
**CALIFORNIA AMERICAN WATER CO.**

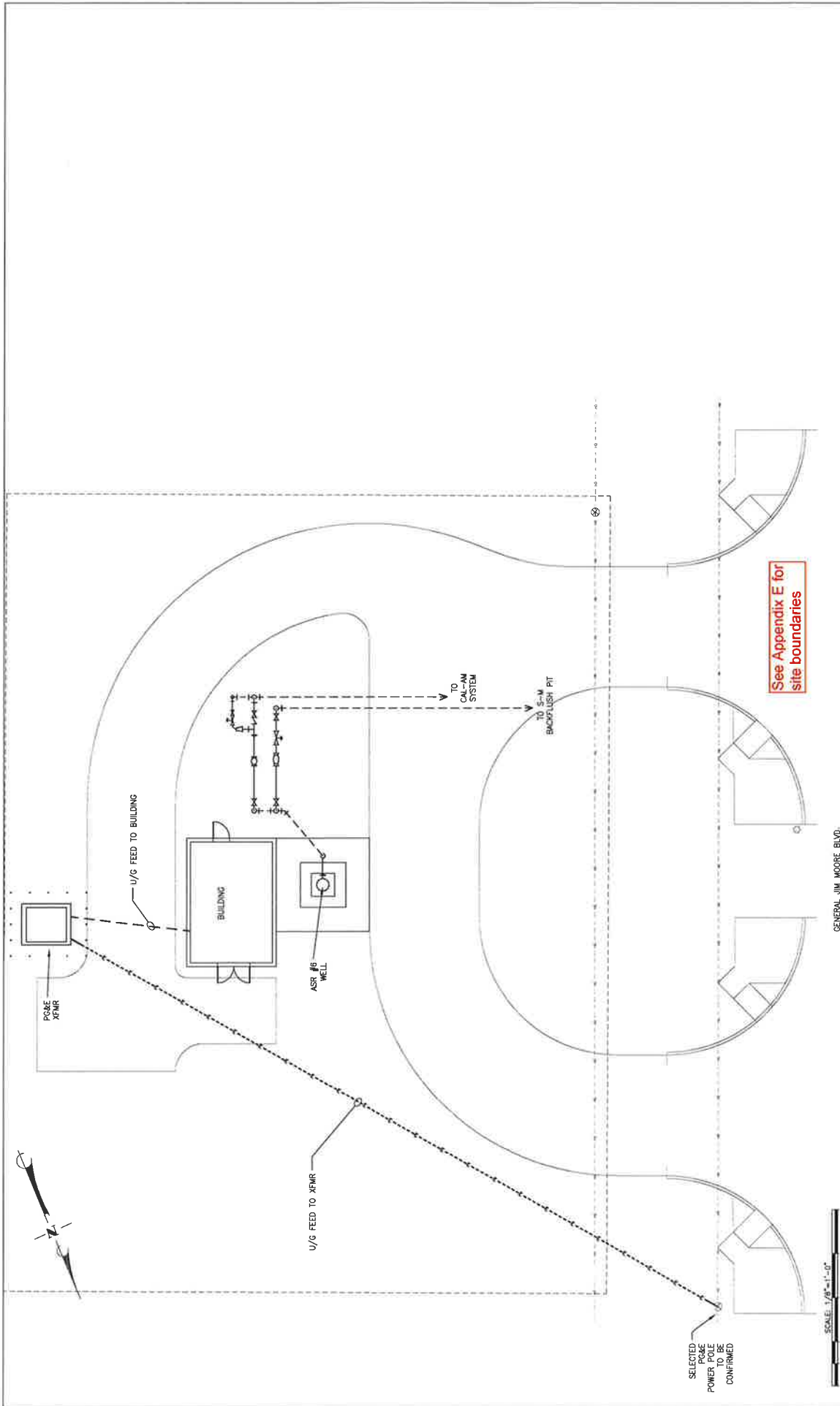

<p>PROJECT NO. _____</p> <p><b>GENERAL LAYOUT</b></p> <p><b>FITCH PARK SITE ASR #6</b></p> <p>FITCH PARK ASR DESIGN-BUILD PROJECT</p> <p>CALIFORNIA AMERICAN WATER CO.</p>			
<p>California American Water</p> <p>511 Forest Lodge Rd, Suite 100 Pacific Grove, CA 9350</p> <p><b>CALIFORNIA AMERICAN WATER</b></p>			
<p>UNAUTHORIZED CHANGES &amp; USES CAUTION: The engineer preparing these plans will not be responsible for, or liable for, unauthorized changes to the plans must be in writing and must be approved by the preparer of these plans.</p>			
DESIGNED 1/2	CHECKED _____		
DRAWN _____	CHECKED _____		
<p><b>WARNING</b> IF THESE PLANS GOES NOT MEASURE IS NOT TO SCALE.</p>			
REV	DATE	BY	DESCRIPTION

SCALE: 1/8"=1'-0"



GENERAL JIM MOORE BLVD.

See Appendix E for site boundaries

SELECTED PG&E XPMR POWER POLE TO BE CONFIRMED

# GENERAL JIM MOORE BLVD.

## DESIGN PARAMETERS

1. ROADWAY SHALL BE DESIGNED TO ACCOMMODATE A WB50 TRUCK.
2. "X" MARKS ON OAK TREES ARE IDENTIFIED FOR REMOVAL/DEMOLITION.

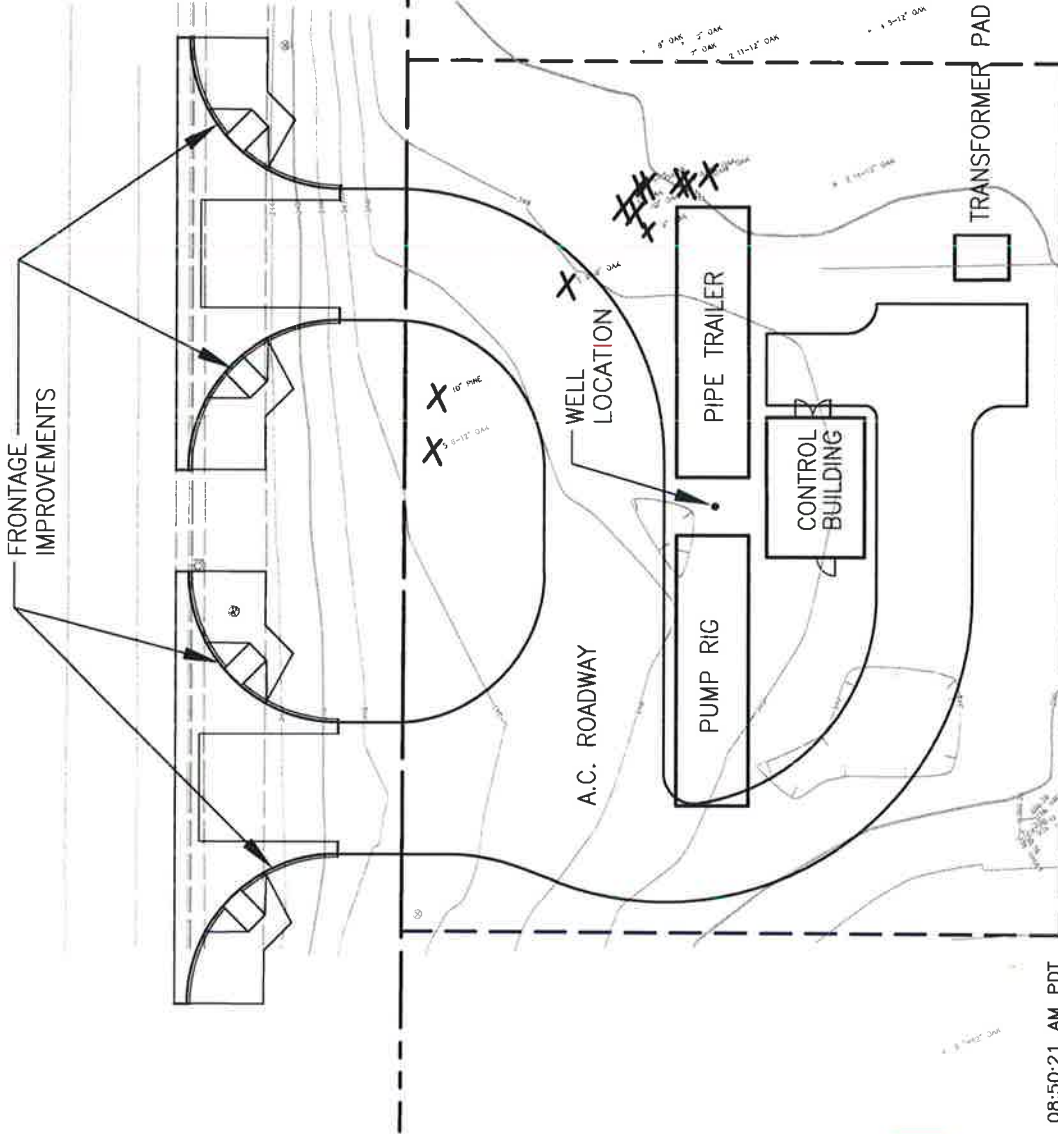

see Appendix E for site boundaries

0478PGDP.DWG 04/09/18 08:50:21 AM PDT

REV	DATE	BY	DESCRIPTION

**WARNING**  
 IF THIS BAR DOES NOT MEASURE 1" THEN THE DRAWING IS NOT TO SCALE

**DESIGNED** \_\_\_\_\_  
**DRAWN** \_\_\_\_\_  
**CHECKED** \_\_\_\_\_

**UNAUTHORIZED CHANGES & USES CAUTION:**  
 The engineer preparing these plans will not be responsible for any changes to or uses of these plans. All changes to the plans must be in writing and must be approved by the preparer of these plans.

California American Water  
 511 Forest Lodge Rd,  
 Pacific Grove, Ca 93950

**EXHIBIT**  
 GENERAL SITE LAYOUT - ASR-6  
 FITCH PARK ASR DESIGN-BUILD PROJECT  
 CALIFORNIA AMERICAN WATER CO.

**PROJECT NO.**  
 PROJECT  
 C-1



**MATERIAL LIST**

ITEM	SIZE	DESCRIPTION	QTY
1	12"	CLAV VALVE, F.L.G.	2
2	12"	W/120V SOLENOID W/ MANUAL OPERATOR, GLOBE STYLE, EPOXY LINED, STAINLESS STEEL TRIM, CHECK FEATURES, PILOT BALL VALVES, OPENING SPEED CONTROL	2
3	12"	CLAV VALVE, F.L.G.	4
4	12"	W/120V SOLENOID W/ MANUAL OPERATOR, GLOBE STYLE, EPOXY LINED, STAINLESS STEEL TRIM, CHECK FEATURES, PILOT BALL VALVES, OPENING SPEED CONTROL	4
5	12"	CLAV VALVE, F.L.G.	6
6	12"	W/120V SOLENOID W/ MANUAL OPERATOR, GLOBE STYLE, EPOXY LINED, STAINLESS STEEL TRIM, CHECK FEATURES, PILOT BALL VALVES, OPENING SPEED CONTROL	2
7	12"	CLAV VALVE, F.L.G.	2
8	12"	W/120V SOLENOID W/ MANUAL OPERATOR, GLOBE STYLE, EPOXY LINED, STAINLESS STEEL TRIM, CHECK FEATURES, PILOT BALL VALVES, OPENING SPEED CONTROL	2
9	12"	CLAV VALVE, F.L.G.	2
10	12"	W/120V SOLENOID W/ MANUAL OPERATOR, GLOBE STYLE, EPOXY LINED, STAINLESS STEEL TRIM, CHECK FEATURES, PILOT BALL VALVES, OPENING SPEED CONTROL	2
11	12"	CLAV VALVE, F.L.G.	1
12	12"	W/120V SOLENOID W/ MANUAL OPERATOR, GLOBE STYLE, EPOXY LINED, STAINLESS STEEL TRIM, CHECK FEATURES, PILOT BALL VALVES, OPENING SPEED CONTROL	1
13	8"	CLAV VALVE, F.L.G.	1
14	8"	W/120V SOLENOID W/ MANUAL OPERATOR, GLOBE STYLE, EPOXY LINED, STAINLESS STEEL TRIM, CHECK FEATURES, PILOT BALL VALVES, OPENING SPEED CONTROL	1
15	8"	CLAV VALVE, F.L.G.	1
16	8"	W/120V SOLENOID W/ MANUAL OPERATOR, GLOBE STYLE, EPOXY LINED, STAINLESS STEEL TRIM, CHECK FEATURES, PILOT BALL VALVES, OPENING SPEED CONTROL	1
17	8"	CLAV VALVE, F.L.G.	1
18	8"	W/120V SOLENOID W/ MANUAL OPERATOR, GLOBE STYLE, EPOXY LINED, STAINLESS STEEL TRIM, CHECK FEATURES, PILOT BALL VALVES, OPENING SPEED CONTROL	1
19	12"	CLAV VALVE, F.L.G.	1
20	12"	W/120V SOLENOID W/ MANUAL OPERATOR, GLOBE STYLE, EPOXY LINED, STAINLESS STEEL TRIM, CHECK FEATURES, PILOT BALL VALVES, OPENING SPEED CONTROL	1
21	8"	CLAV VALVE, F.L.G.	1
22	8"	W/120V SOLENOID W/ MANUAL OPERATOR, GLOBE STYLE, EPOXY LINED, STAINLESS STEEL TRIM, CHECK FEATURES, PILOT BALL VALVES, OPENING SPEED CONTROL	1
23	12"	CLAV VALVE, F.L.G.	1
24	12"	W/120V SOLENOID W/ MANUAL OPERATOR, GLOBE STYLE, EPOXY LINED, STAINLESS STEEL TRIM, CHECK FEATURES, PILOT BALL VALVES, OPENING SPEED CONTROL	1
25	12"	CLAV VALVE, F.L.G.	1

**NOTES:**

- 12" CLAV VALVE MODEL 650E-G-03B5K-C-DS W/120V SOLENOID W/ MANUAL OPERATOR, GLOBE STYLE, EPOXY LINED, STAINLESS STEEL TRIM, CHECK FEATURES, PILOT BALL VALVES, OPENING SPEED CONTROL
- 8" CLAV VALVE MODEL 93E-G-01B5K-C-DS W/120V SOLENOID W/ MANUAL OPERATOR, GLOBE STYLE, EPOXY LINED, STAINLESS STEEL TRIM, CHECK FEATURES, PILOT BALL VALVES, OPENING SPEED CONTROL
- ALL SPOOLS SHALL BE SCH. 40 STEEL, FUSION BONDED EPOXY COATED PER AWWA D215.
- WATER SPECIALTIES ML-04 METER, 12" SIZE, INDICATOR & TOTALIZER IN GALLONS, STANDARD VELOCITY CONSTRUCTION.

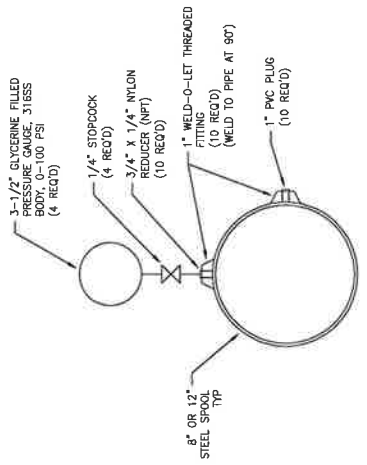

NOTE: LOCATE THREAD-O-LETS 6" FROM SPOOL ENDS

**A TYPICAL PRESSURE GAUGE & SAMPLE PORTS**  
ON ALL 8" & 12" PIPE SPOOLS

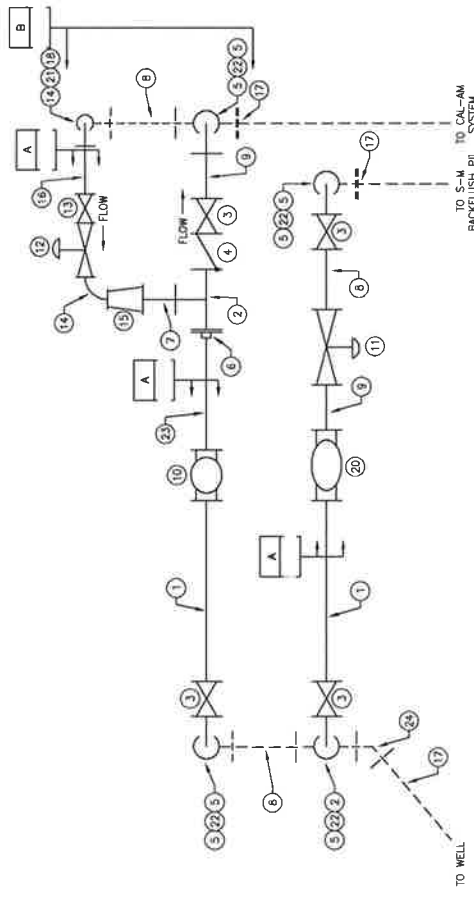

**1 PIPING PLAN**  
SCALE: 1/2" = 1'-0"

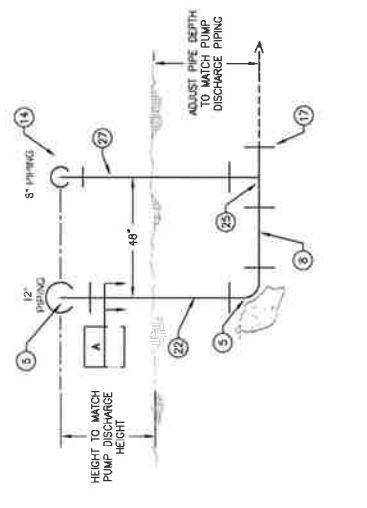

**B UNDERGROUND INTERTIE DETAIL**  
SCALE: 1/2" = 1'-0"

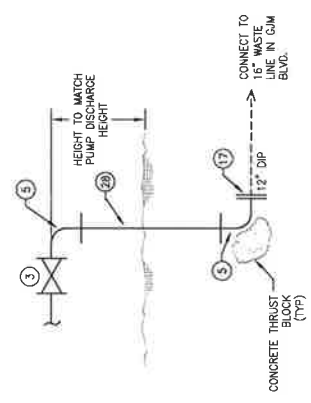

**C FLUSH PIPING ELEVATION**  
SCALE: 1/2" = 1'-0"

REV	DATE	BY	DESCRIPTION

<p><b>WARNING</b> UNAUTHORIZED CHANGES &amp; USES CAUTION: The engineer preparing these plans will not be responsible for, or liable for, unauthorized changes or use of these plans. It is the responsibility of the user to ensure that these plans are used in accordance with the specifications and must be approved by the preparer of these plans.</p>		<p>California American Water 511 Forest Lodge Rd. Suite 100 Pacific Grove, Ca 93950</p>
<p>DESIGNED 1/2/11 DRAWN CHECKED</p>		<p><b>MECHANICAL PLAN</b> FITCH PARK SITE ASR #6 FITCH PARK ASR DESIGN-BUILD PROJECT CALIFORNIA AMERICAN WATER CO.</p>
<p>PROJECT NO. _____</p>		<p>M-1</p>



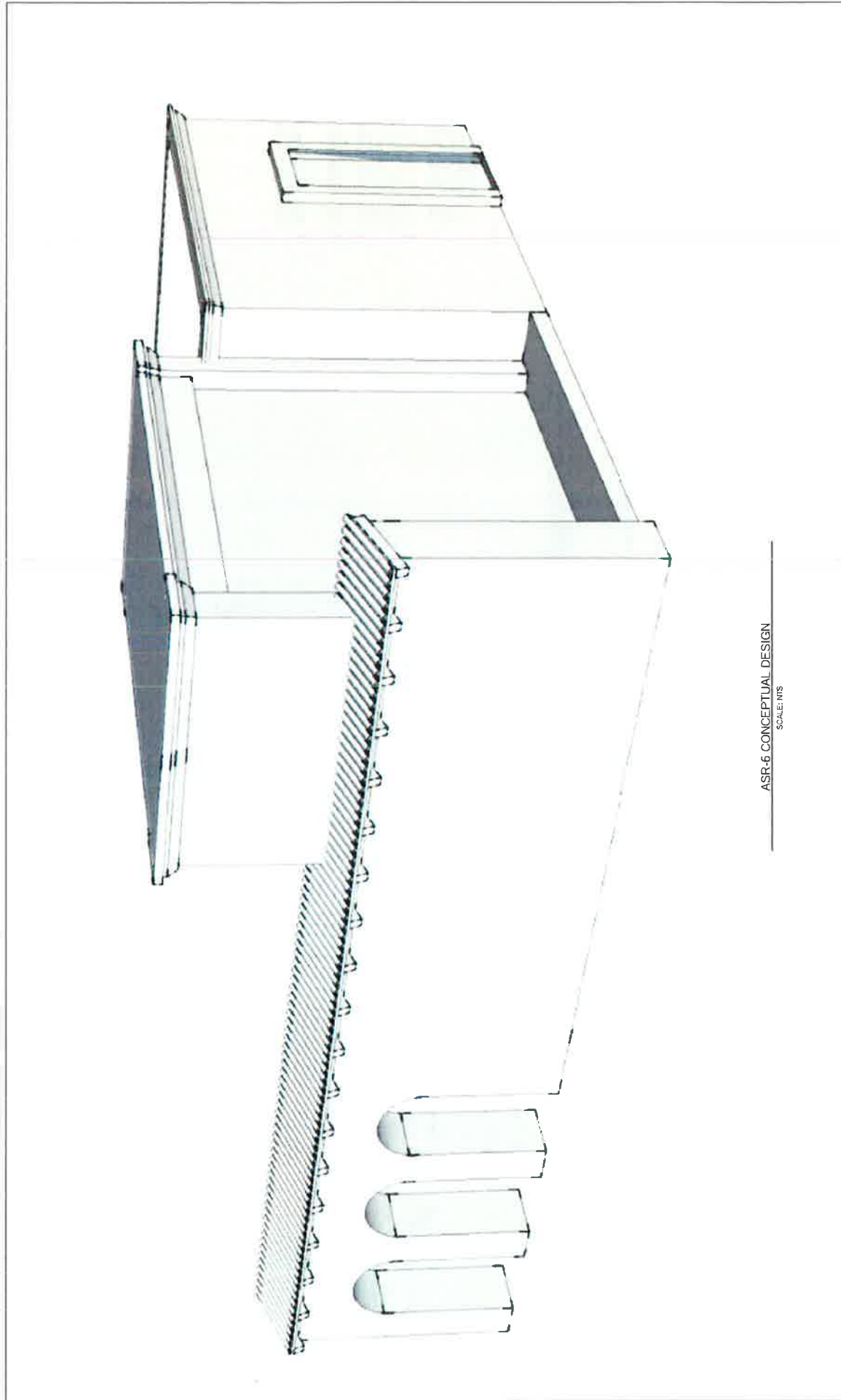

ASR-6 CONCEPTUAL DESIGN

SCALE: NTS

PROJECT NO.	—
ARCHITECTURAL MASS STUDY FITCH PARK SITE ASR #6 FITCH PARK ASR DESIGN-BUILD PROJECT CALIFORNIA AMERICAN WATER CO.	A-1
 California American Water 511 Forest Lodge Rd. Pacific Grove, Ca 9350	
UNAUTHORIZED CHANGES & USES CAUTION: The engineer preparing these plans will not be responsible for any errors or omissions or for any changes to or uses of these plans. All changes to the plans must be in writing and must be approved by the preparer of these plans.	
DESIGNED 1/2 DRAWN CHECKED	
WARNING IF THIS BAR DOES NOT MEASURE THE DRAWING IS NOT TO SCALE	
REV.	DATE
BY	DESCRIPTION



**NOTE: FINAL LOADS & EQUIPMENT SIZING TO BE DETERMINED**

**FOR A MORE COMPLETE ONE LINE DIAGRAM OF EXPECTED VFD COMPONENTS SEE SAMPLE**

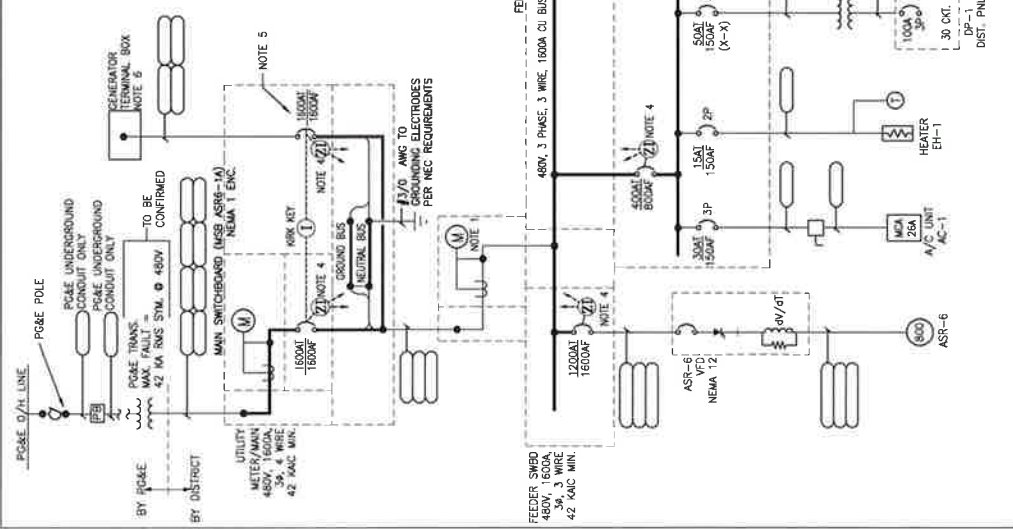

ONE-LINE DIAGRAM

**NOTES**

- CUSTOMER METERS WITH MOBILE TOP ETHERNET CAPABILITY, UNIT IS CAPABLE OF MONITORING DEMAND, KW, KVAR, KVA, KWH, KWHR, VOLTS, AMPS AND HARMONICS.
- MAIN BREAKERS AND GENERATOR BREAKERS ARE INSULATED CASE BREAKER, SOLID STATE TRIP WITH LONG TIME, SHORT TIME AND GROUND FAULT TRIP FUNCTIONS.
- VFD BREAKER IS AN INSULATED CASE BREAKER, SOLID STATE TRIP WITH LONG TIME, SHORT TIME, GROUND FAULT AND SHUNT TRIP FUNCTIONS.
- VFD FEEDER BREAKER & SUBPANEL MAIN BREAKER ARE ZONE INTERLOCKED (ZI) WITH MSB ASRB-1A MAIN AND GENERATOR BREAKER.
- STANDBY GENERATOR BREAKER SHALL BE INTERLOCKED WITH THE MAIN BREAKER, BOTH BREAKERS CANNOT BE CLOSED SIMULTANEOUSLY.
- STANDBY GENERATOR CONNECTION IS SIZED TO FEED THE ENTIRE FACILITY LOAD.

MSB & FEEDER LOAD SCHEDULE				
MOTOR TAG NO.	M OR F	PHASE H.P. OR FEEDER(F) KW	F.L.A. DESCRIPTION	
ASR-6 WELL	M	3	803	WELL MOTOR/VFD
MCC LOADS	F	139	168	FROM MCC SCHEDULE BELOW - INCLUDES LCL
TOTAL CURRENT			1041	
LARGEST MOTOR X .35			223	
FEEDER L.L.C. X .25			1224	
TOTAL KVA			1007	
SUBPANEL OR MCC LOAD SCHEDULE				
MOTOR TAG NO.	M OR F	PHASE H.P. OR FEEDER(F) KW	F.L.A. DESCRIPTION	
AC-1	F	3	48.1	A/C UNIT
EH-1	F	3	2.0	ELECTRIC HEATER
BP-1	M	3	2.0	COMBINED POTABLE WATER BOOSTER PUMPS FEEDER
BP-2	M	3	2.0	COMBINED POTABLE WATER BOOSTER PUMPS FEEDER
FEEDER LOADS	F	3	25.0	L.T.G. TRANSFORMER (LCL/ZI/VFD)
TX-ASRB-1P1	F	3	6.3	INSTRUMENT TRANSFORMER
TOTAL CURRENT			123.5	LARGEST LEG CURRENT
LARGEST MOTOR X .25			6.9	
FEEDER L.L.C. X .25			40.3	
TOTAL KVA			107.8	
TOTAL KVA			139.1	

PROJECT NO.	
ONE LINE DIAGRAM	
FITCH PARK SITE ASR #6	
FITCH PARK ASR DESIGN-BUILD PROJECT	
CALIFORNIA AMERICAN WATER	
California American Water 511 Forest Lodge Rd, Suite 100 Pacific Grove, Ca 9360	
UNAUTHORIZED CHANGES & USES CAUTION: The engineer preparing these plans will not be responsible for, or liable for, unauthorized use, modification, or reproduction of these plans to the plans must be in writing and must be approved by the preparer of these plans.	
DESIGNED J2-1	
DRAWN	
CHECKED	
WARNING: THESE PLANS DO NOT CONSTITUTE A CONTRACT. IF YOU HAVE ANY QUESTIONS THEN DRAWING IS NOT TO SCALE	
REV	DATE BY DESCRIPTION

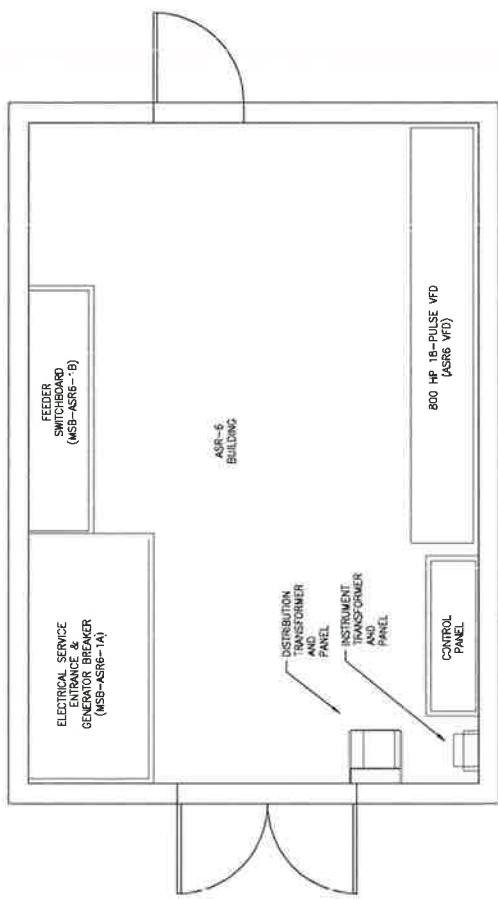

ASR #6 BUILDING LAYOUT

SCALE: 1/2"=1'-0"

REV	DATE	BY	DESCRIPTION

**WARNING**  
 IF THIS DRAWING IS NOT MEASURED THEN DRAWING IS NOT TO SCALE

DESIGNED 1/2/11  
 DRAWN \_\_\_\_\_  
 CHECKED \_\_\_\_\_

**UNAUTHORIZED CHANGES & USES CAUTION:**  
 The engineer preparing these plans will not be responsible for, or liable for, unauthorized changes to the plans. All changes must be in writing and must be approved by the preparer of these plans.

California American Water  
 511 Forest Lodge Rd.  
 Suite 100  
 Pacific Grove, CA 93950



**BUILDING ELECTRICAL LAYOUT**  
**FITCH PARK SITE ASR #6**  
 FITCH PARK ASR DESIGN-BUILD PROJECT  
 CALIFORNIA AMERICAN WATER CO.

PROJECT NO. \_\_\_\_\_  
**E-2**

NOTE: CHEMICAL STORAGE & DISPENSING BUILDING AND PIPING NOT SHOWN

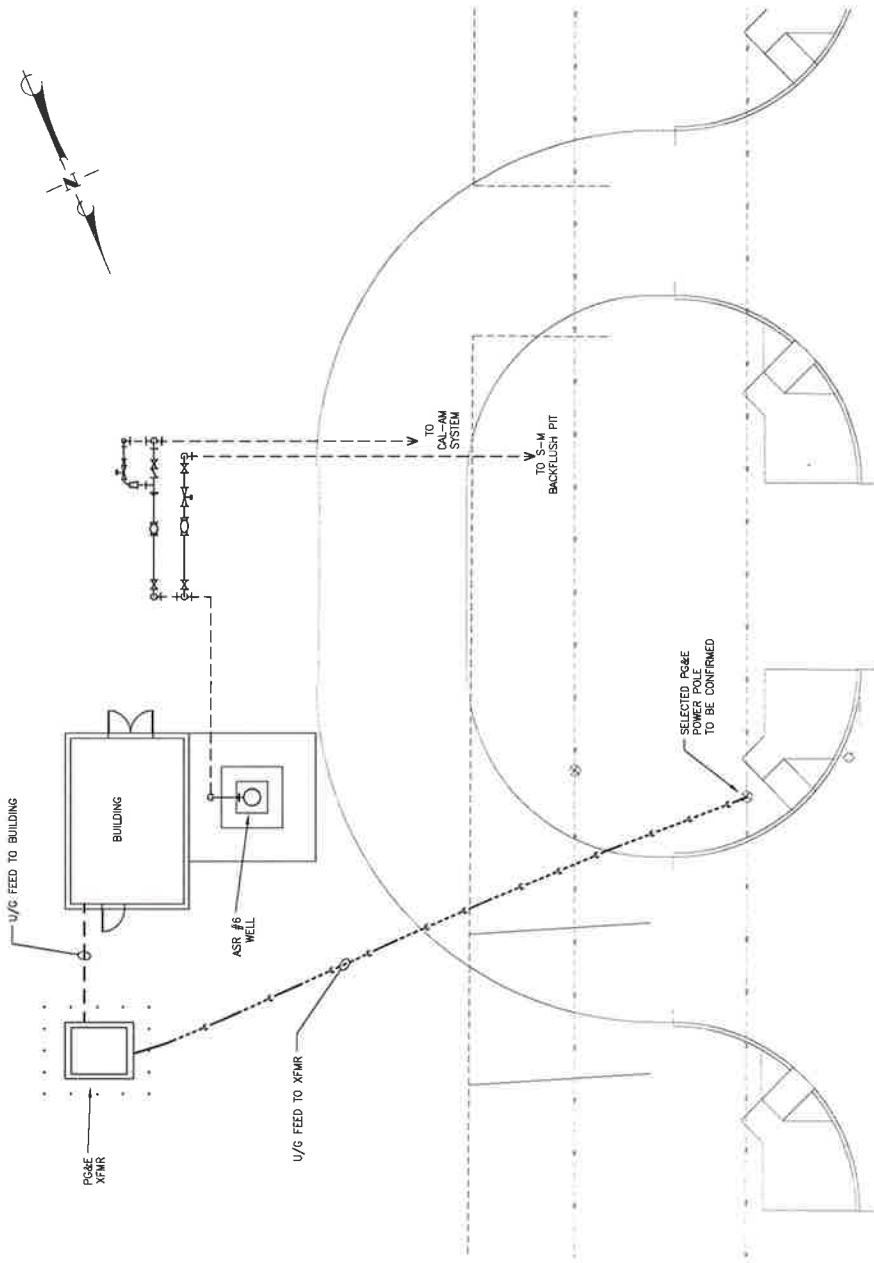

GENERAL JIM MOORE BLVD.



REV	DATE	BY	DESCRIPTION

**WARNING**  
 IF THIS BAG DOES NOT SAY "NOT TO SCALE" THEN DRAWING IS NOT TO SCALE.

DESIGNED 1/2  
 DRAWN  
 CHECKED

California American Water  
 511 Forest Lodge Rd,  
 Suite 100  
 Pacific Grove, Ca 9390



GENERAL LAYOUT  
 FITCH PARK SITE ASR #5  
 FITCH PARK ASR DESIGN-BUILD PROJECT  
 CALIFORNIA AMERICAN WATER CO.

PROJECT NO. G-2

**GENERAL JIM MOORE BLVD.**

FRONTAGE IMPROVEMENTS

**DESIGN PARAMETERS**

1. ROADWAY SHALL BE DESIGNED TO ACCOMMODATE A WB50 TRUCK.
2. NOTE: CHLORINATION BUILDING NOT SHOWN.
3. "X" MARKS ON OAK TREES ARE IDENTIFIED FOR REMOVAL/DEMOLITION.

see Appendix E for site data

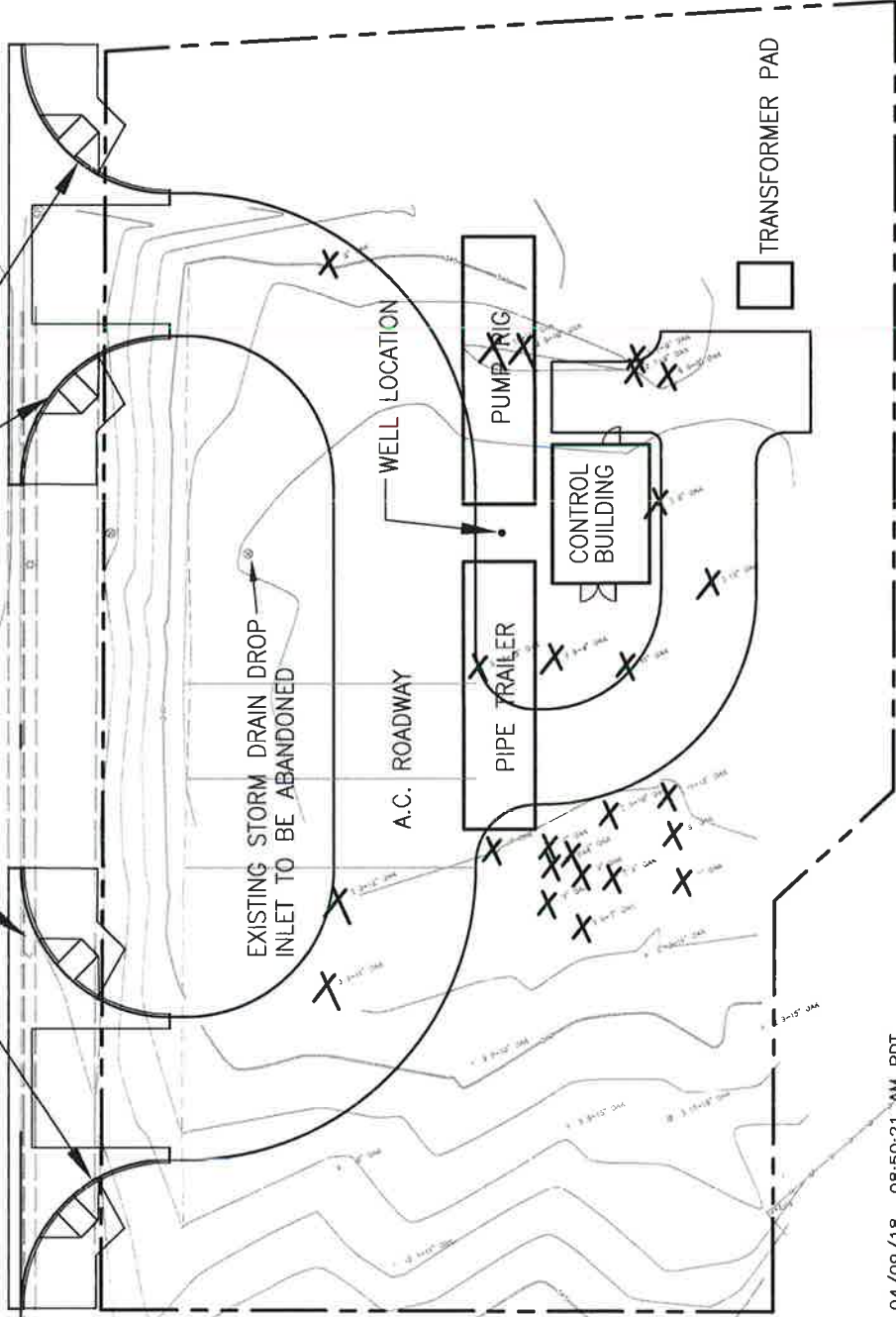

SCALE: 1" = 20'

0478PGDP.DWG 04/09/18 08:50:21 AM PDT

WARNING  
1/2"  
IF THIS BAR DOES  
NOT MEASURE  
THEN DRAWING IS  
NOT TO SCALE

DESIGNED  
DRAWN  
CHECKED

UNAUTHORIZED CHANGES & USES CAUTION:  
The engineer preparing these plans will not be responsible for, and the contractor accepting them will be bound by, any changes to the plans that are not in writing and must be approved by the preparer of these plans.

California American Water  
511 Forest Lodge Rd,  
Suite 100  
Pacific Grove, Ca 93950



EXHIBIT  
GENERAL SITE LAYOUT - ASR-5  
FITCH PARK ASR DESIGN-BUILD PROJECT  
CALIFORNIA.AMERICAN.WATER.CO

PROJECT NO.  
PROJECT  
C-2

KEY	DATE	BY	DESCRIPTION

**MATERIAL LIST**

ITEM	PIPE SIZE	DESCRIPTION	QTY
1	12"	72" LONG SPOOL, FLG.	2
2	12"	FLG. TEE	3
3	12"	1/2" VALVE WITH HANDWHEEL	4
4	12"	APCO MOD. 812 CHECK VALVE	4
5	12"	90° ELBOW, FLG.	6
6	12"	DRESSER STYLE 128 FLANGE ADAPTOR	2
7	12"	13" LONG SPOOL, FLG.	2
8	12"	18" LONG SPOOL, FLG.	3
9	12"	18" LONG SPOOL, FLG.	2
10	12"	SPARKLING TIGER MAG 657 METER	1
11	12"	CLAWVALVE 650 (SEE NOTE 1)	1
12	12"	CLAWVALVE 650 (SEE NOTE 2)	1
13	8"	GATE VALVE, FLG.	1
14	8"	90° ELBOW, FLG.	2
15	8"	8 X 12" REDUCER, FLG.	1
16	8"	15-2/8" LONG SPOOL, FLG.	1
17	12"	MEGAFLANGE ADAPTOR	2
18	12"	8 X 12" REDUCING ELBOW, FLG.	2
19	12"	8 X 12" REDUCING ELBOW, FLG. WITH TIE BACK LUGS, 2" THREAD-O-LET	1
20	12"	WATER SPECIALTIES ML-04 METER	1
21	8"	SEE NOTE 4	1
22	12"	SPOOL, 75" LONG	3
23	12"	SPOOL, 72" LONG	4
24	12"	TIE BACK LUG, LONG, FLG. X P.E. WITH 45° ELBOW, FLG.	1
25	12"	12 X 8 X 12" (R-9-R) TEE, FLG.	1

**NOTES:**

- 12" CLAWVALVE MODEL 650E-G-03B5KIC-DS W/ 1/2" SOLENOID W/ MANUAL OPERATOR, GLOBE STYLE, EPXY LINED, STAINLESS STEEL TRIM, CHECK FEATURES, PILOT BALL VALVES, OPENING SPEED CONTROL.
- 8" CLAWVALVE MODEL 93E-G-01B5KIC-DS W/ 1/2" SOLENOID W/ MANUAL OPERATOR, GLOBE STYLE, EPXY LINED, STAINLESS STEEL TRIM, CHECK FEATURES, GLOBE SHUTOFF, PILOT BALL VALVES, OPENING AND CLOSING SPEED CONTROL.
- ALL SPOOLS SHALL BE SCH. 40 STEEL FUSION BONDED EPOXY COATED PER AWWA D213.
- WATER SPECIALTIES ML-04 METERS, 12" SIZE, INDICATOR & TOTALIZER IN GALLONS, STANDARD VELOCITY CONSTRUCTION.

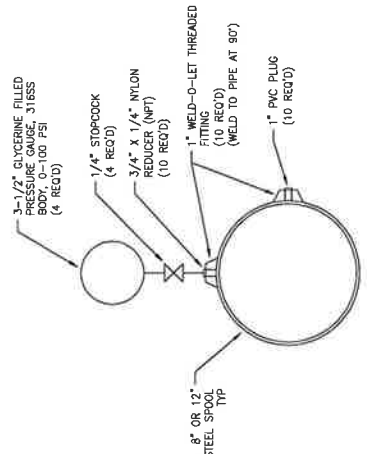

**TYPICAL PRESSURE GAUGE & SAMPLE PORTS**  
ON ALL 8" & 12" PIPE SPOOLS

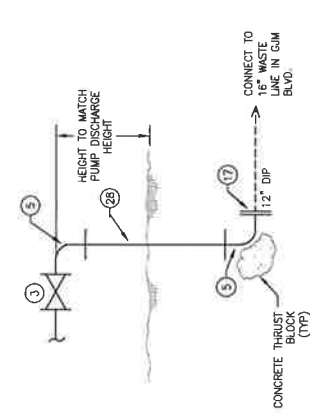
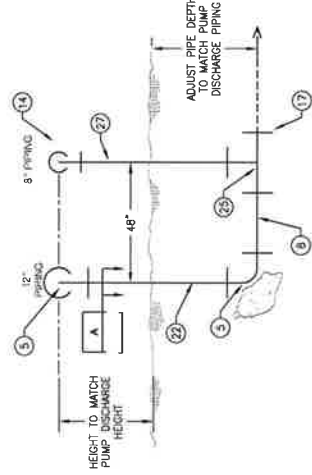
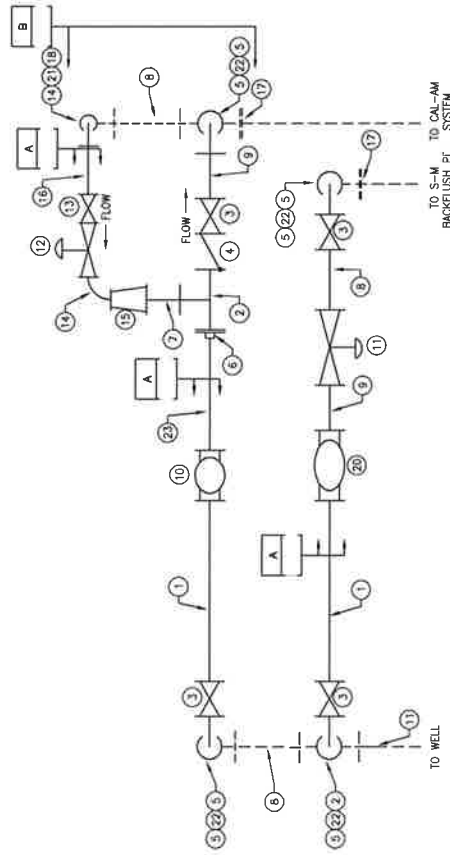

		<b>MECHANICAL PLAN</b> <b>FITCH PARK SITE ASR #5</b> <b>FITCH PARK ASR DESIGN/BUILD PROJECT</b> CALIFORNIA AMERICAN WATER CO.		PROJECT NO. M-2
UNAUTHORIZED CHANGES & USES CAUTION: The engineer preparing these plans will not be responsible for, or liable for, unauthorized changes to the plans. Any changes to the plans must be in writing and must be approved by the preparer of these plans.	California American Water 511 Forest Lodge Rd. Suite 100 Pacific Grove, Ca 9550	DESIGNED 1/2 DRAWN CHECKED	WARNING: THESE PLANS ARE FOR CONSTRUCTION ONLY. ANY CHANGES TO THESE PLANS MUST BE APPROVED BY THE PREPARER OF THESE PLANS. NOT TO SCALE.	REV DATE BY DESCRIPTION



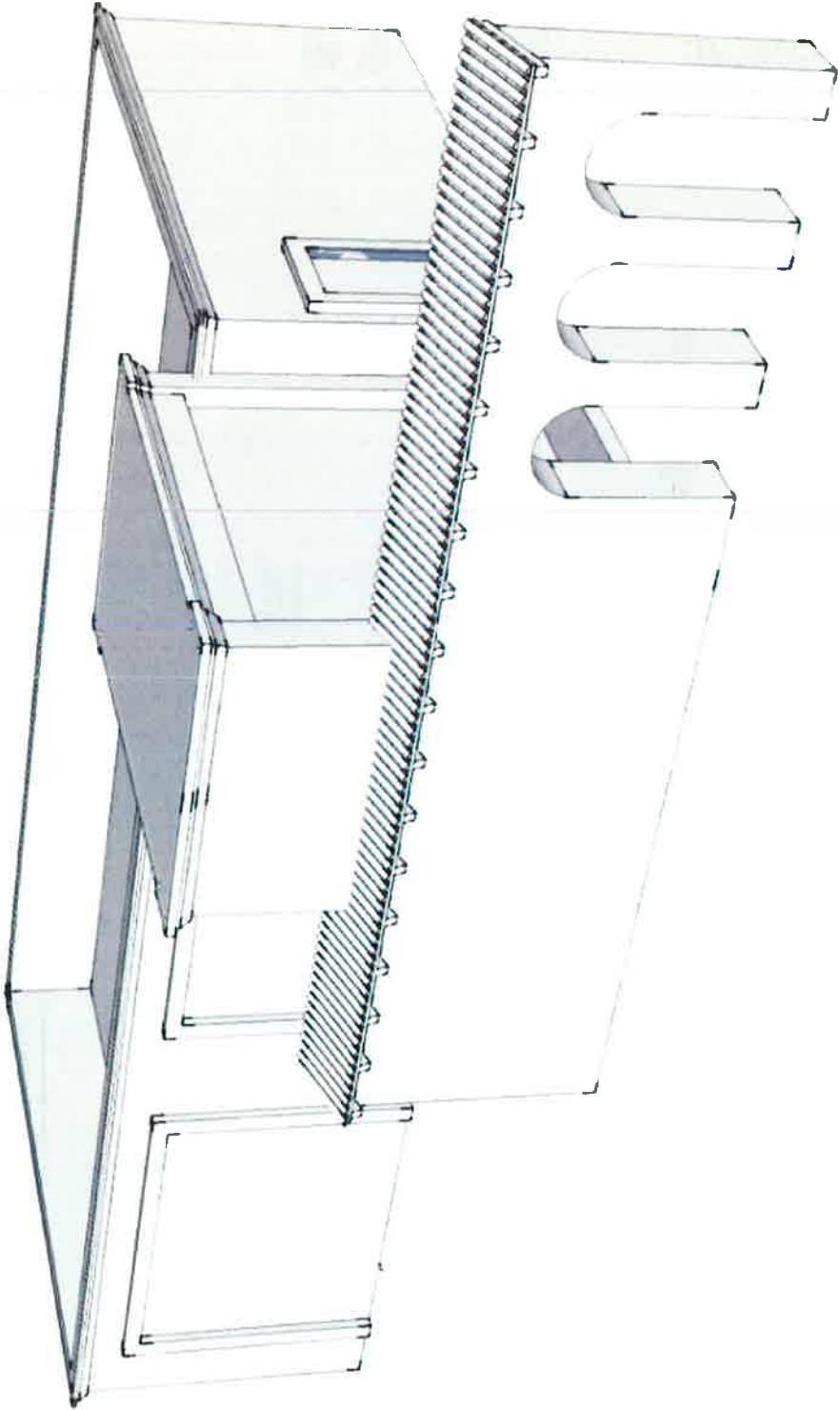

ASR-5 CONCEPTUAL DESIGN  
SCALE: 1/8" = 1'-0"

<p>PROJECT NO. _____</p> <p><b>A-2</b></p>		<p><b>ARCHITECTURAL MASS STUDY</b>  <b>FITCH PARK SITE ASR #5</b>  <b>FITCH PARK ASR DESIGN-BUILD PROJECT</b>  <b>CALIFORNIA AMERICAN WATER CO.</b></p>		 <p><b>CALIFORNIA AMERICAN WATER</b></p>		<p>California American Water          511 Forest Lodge Rd.          Suite 100          Pacific Grove, CA 93950</p>		<p><b>UNAUTHORIZED CHANGES &amp; USES CAUTION:</b>          The engineer preparing these plans will not be responsible for, or liable for, any consequences that may result from unauthorized changes to the plans must be in writing and must be approved by the preparer of these plans.</p>		<p>DESIGNED 1/2" = 1'-0"</p> <p>DRAWN _____</p> <p>CHECKED _____</p>		<p><b>WARNING</b>          IF THIS BAR DOES NOT MEASURE THEN DRAWING IS NOT TO SCALE.</p>		<table border="1"> <thead> <tr> <th>REV</th> <th>DATE</th> <th>BY</th> <th>DESCRIPTION</th> </tr> </thead> <tbody> <tr><td> </td><td> </td><td> </td><td> </td></tr> <tr><td> </td><td> </td><td> </td><td> </td></tr> <tr><td> </td><td> </td><td> </td><td> </td></tr> <tr><td> </td><td> </td><td> </td><td> </td></tr> </tbody> </table>		REV	DATE	BY	DESCRIPTION																
REV	DATE	BY	DESCRIPTION																																



NOTE: FINAL LOADS & EQUIPMENT SIZING TO BE DETERMINED

NOTE: CHEMICAL STORAGE & DISPENSING BUILDING AND EQUIPMENT LOADS NOT SHOWN

FOR A MORE COMPLETE EXAMPLE OF ONE-LINE EXPECTED VFD SCHEMATIC FOR THIS JOB SEE SAMPLE

FOR THE EXPECTED VFD SCHEMATIC FOR THIS JOB SEE SAMPLE

- NOTES**
- CUSTOMER METERS WITH MORBUS TOP ETHERNET CAPABILITY UNIT IS CABLE OF NETWORKING DEMAND, RM, MW, KVA, MW, MVAR, VOLT, S, AMPS AND HARMONICS.
  - MAIN BREAKER AND GENERATOR BREAKER ARE INSULATED CASE BREAKER, SOLID STATE TRIP WITH LONG TIME, SHORT TIME AND GROUND FAULT TRIP FUNCTIONS.
  - VFD BREAKER IS AN INSULATED CASE BREAKER, SOLID STATE TRIP WITH LONG TIME, SHORT TIME, GROUND FAULT AND SHUNT TRIP FUNCTIONS.
  - VFD FEEDER BREAKER & SUBPANEL MAIN BREAKER ARE ZONE INTERLOCKED (Z) WITH MSB ASRS-1A MAIN AND GENERATOR BREAKER.
  - STANDBY GENERATOR BREAKER SHALL BE INTERLOCKED WITH THE MAIN BREAKER, BOTH BREAKERS CANNOT BE CLOSED SIMULTANEOUSLY.
  - STANDBY GENERATOR CONNECTION IS SIZED TO FEED THE ENTIRE FACILITY LOAD.

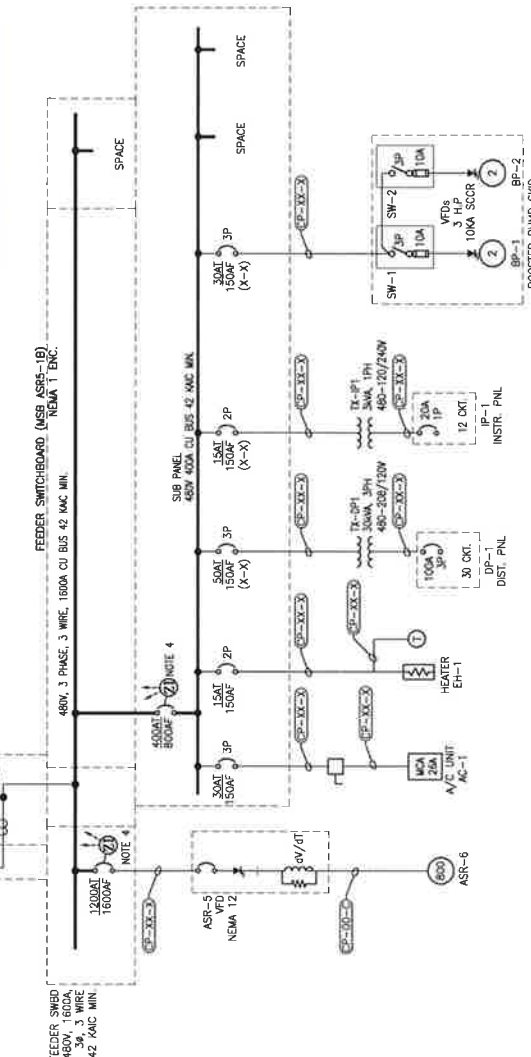

ONE-LINE DIAGRAM

MSB & FEEDER LOAD SCHEDULE					
MOTOR TAG NO.	M OR F	PHASE H.P. OR FEEDER(KW)	F.L.A. DESCRIPTION		
ASR-5 WFL	M	3	800	893	WELL MOTOR/VFD
MCC LOADS					
TOTAL CURRENT		F	3	139	FROM MCC SCHEDULE BELOW - INCLUDES L.C.
LARGEST MOTOR X .25				1061	
FEEDER L.L.X				223	
TOTAL CURRENT				1384	
TOTAL KVA				1067	
SUBPANEL OR MCC LOAD SCHEDULE					
MOTOR TAG NO.	M OR F	PHASE H.P. OR FEEDER(KW)	F.L.A. DESCRIPTION		
AC-1	F	3	40.0	48.1	AC UNIT
EH-1	F	3	2.0	3.4	ELECTRIC HEATER
BP-1	M	3	2.0	3.4	COMBINED POTABLE WATER BOOSTER PUMPS FEEDER
BP-2	M	3	2.0	3.4	
FEEDER LOADS					
TX-ASRS-0P1	F	3	30.0	36.1	L.T.C. TRANSFORMER (DREJ100V)
TX-ASRS-1P1	F	3	3.0	6.3	INSTRUMENT TRANSFORMER
TOTAL CURRENT				123.5	LARGEST LEG CURRENT
LARGEST MOTOR X .25				9.9	
FEEDER L.L.X				43.2	
TOTAL CURRENT				167.6	
TOTAL KVA				139.3	

REV	DATE	BY	DESCRIPTION
<p>WARNING: THE ENGINEER HAS REVIEWED THIS DRAWING AND CONFIRMS THAT THE DRAWING IS NOT TO SCALE.</p>			
DESIGNED 1/2-1		DRAWN	
CHECKED			
<p>UNAUTHORIZED CHANGES &amp; USES CAUTION: The engineer preparing these plans will not be responsible for, or liable for, unauthorized changes to or uses of these plans. All changes must be approved by the preparer of these plans.</p>			
<p>California American Water            511 Forest Lodge Rd.            Suite 100            Pacific Grove, Ca 9550</p>			
<p>AMERICAN WATER CALIFORNIA</p>			
<p>ONE LINE DIAGRAM            FITCH PARK SITE ASR #5            FITCH PARK ASR DESIGN-BUILD PROJECT            CALIFORNIA AMERICAN WATER CO.</p>			
PROJECT NO.			E-3

NOTE: CHEMICAL STORAGE & DISPENSING BUILDING AND PIPING NOT SHOWN

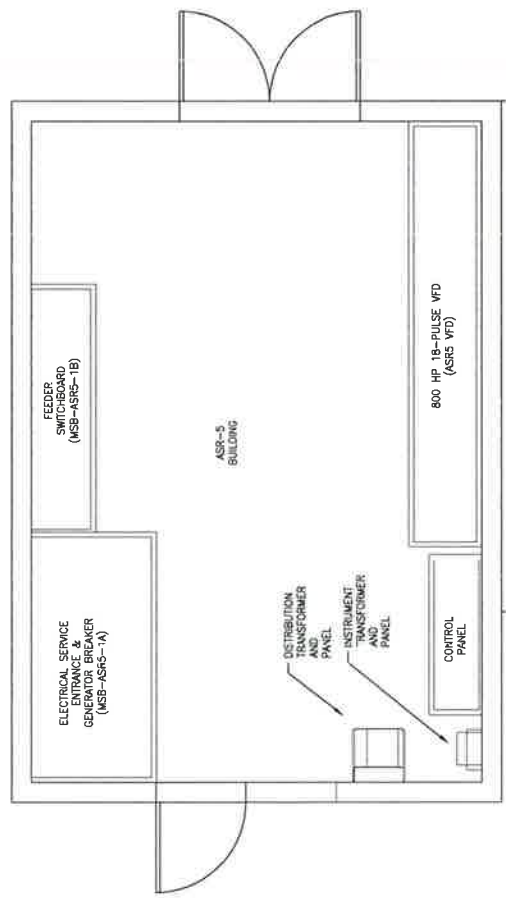

ASR #5 BUILDING LAYOUT

REV	DATE	BY	DESCRIPTION

WARNING  
IF YOU ARE NOT A LICENSED PROFESSIONAL ENGINEER, DO NOT MAKE CHANGES TO THIS DRAWING. ANY CHANGES MUST BE APPROVED BY THE PREPARED BY.

DESIGNED 1/2/11  
DRAWN \_\_\_\_\_  
CHECKED \_\_\_\_\_

UNAUTHORIZED CHANGES & USES CAUTION:  
The engineer preparing these plans will not be responsible for, or liable for, unauthorized changes to the plans. Any changes to the plans must be in writing and must be approved by the preparer of these plans.

California American Water  
511 Forest Lodge Rd,  
Suite 100  
Pacific Grove, Ca 93950



BUILDING ELECTRICAL LAYOUT  
FITCH PARK SITE ASR #5  
FITCH PARK ASR DESIGN-BUILD PROJECT  
CALIFORNIA AMERICAN WATER CO.

PROJECT NO.  
E-4



## **Appendix 2**

### **Project Technical Memoranda**

Project Facilities Permitting TM: 6-6-17

Process and P&ID TM: 6-8-17

Well Pump Sizing Estimate: 6-2-17

Electrical Service Alternatives TM: 7-27-17

Hypochlorite Dosing Estimate: 9-26-17

Chlorination Design Issues TM: 10-4-17



---

**TECHNICAL MEMORANDUM**

**Pueblo Water Resources, Inc.**

4478 Market St., Suite 705  
Ventura, CA 93003

Tel: 805.644.0470

Fax: 805.644.0480



---

To: Donald Robert Monette, Project Mgr      Date: May 12, 2017  
Copy to: Chris Cook, PE, Engineering Mgr.      Project No: 15-0132  
From: Stephen P Tanner, PE  
Subject: Jurisdiction & Permit Oversight Issues for Fitch Park ASR Facility

In accordance with our recent discussions, we are providing herein a summary of pertinent permitting and jurisdictional issues we believe will be applicable to the proposed ASR facilities at the Fitch Park site. We acknowledge that this project has numerous overlapping areas of planning, permitting, and implementation, and we want to establish the correct and most efficient plan for moving the project through the various regulatory processes.

The project is envisioned to include the following features:

- Two ASR wells, outfitted with 800 Hp, electric motor driven, lineshaft turbine pumps
- An Electrical / Controls Building of 500-700 square feet (sf) size
- Aboveground and underground piping to convey the produced waters, utility waters and waste discharges off site
- Site grading and drainage improvements
- Paved ingress and egress access from general Jim Moore Blvd

As a potable water production facility, we opine that the facility is exempt from general planning and zoning review processes. The facility design and construction is, however intended to comply with applicable code provisions and design standards for potable water production facilities. The primary project element subject to regulatory oversight is the Electrical/Controls building; the envisioned building features are summarized in Table 1 below.



**Table 1 – Fitch Park Electrical Building Features Summary**

<b>Building Size (square Feet)</b>	500-700
<b>Construction</b>	Type V-B; Non-combustible CMU and/or reinforced concrete,
<b>Building Occupancy Classification</b>	Utility (Class U)
<b>Interior Plumbing</b>	None
<b>Restroom</b>	None
<b>Building Contents</b>	Electrical Switchgear, motor starter/drives, PLC controls
<b>Windows</b>	None
<b>Interior lighting</b>	Yes
<b>HVAC</b>	Yes, for equipment cooling only
<b>Chemical Storage</b>	None
<b>Equipment/Parts Storage</b>	Yes – (non-hazardous materials / spare parts / maintenance)
<b>Occupancy Status</b>	Unmanned facility, no ongoing personnel duty assignment

The building is proposed to be designed in accordance with the following standards:

- California Building Code (CBC)
- California Electrical Code (CEC)
- California Mechanical Code (CMC)
- CA Title 24 Energy Efficiency Stds.

We opine that the following agencies may be involved in processing permits for the facility:

- Presidio of Monterey: - Fire Department (fire protection and plan review)  
 - Building & Safety (building permit)



- Land Use Permit (building , landscaping, security fencing architectural review)
- Site Grading / Site Civil Improvements / tree removal
- City of Seaside: General Jim Moore Blvd Encroachment (encroachment permit)
- State Water Resources Control Board: Amendment to Cal-Am Water System Permit

Some of the above-cited permits may involve other agencies, or include multiple agency review; these items should be identified as soon as possible to expedite project implementation.

We hope this summary assists Cal-Am in the advancement of this portion of the project. Please call us if you have questions or desire to meet to discuss these issues.

---

**TECHNICAL MEMORANDUM****Pueblo Water Resources, Inc.**

4478 Market St., Suite 705

Ventura, CA 93003

Tel: 805.644.0470

Fax: 805.644.0480



---

To:	<u>Donald Monette, PE, Project Mgr</u>	Date:	<u>June 6, 2017</u>
Copy to:	<u>Chris Cook, PE, Engineering Mgr.</u>	Project No:	<u>15-0132</u>
From:	<u>Stephen Tanner, PE</u>		
Subject:	<u>Preliminary P&amp;ID for Fitch Park ASR Facility - <b>DRAFT</b></u>		

---

In accordance with our recent discussions, we have completed a preliminary Piping and Instrumentation Diagram (P&ID) for the Fitch Park ASR facility. The intent in issuing this drawing early is to allow circulation and review by Cal-Am staff to ensure all have a uniform understanding of the proposed features and functions of the proposed facility and its intended integration into the regional project and the Cal-Am system in general.

As discussed previously, the facility has 4 general operating modes:

1. *Injection/Recharge mode*, which will occur at a design rate of 1,500 gpm for each of the 2 wells (for a facility total of 3,000 gpm, or 4.32 MGD); recharge operation is designed to accommodate single or dual well simultaneous injection. Injection rate is adjustable between 500-1500 gpm via a downhole flow control valve (FCV-501). The anticipated recharge season is 4 months per year on average, which results in an annual/seasonal recharge capacity of 1,590 acre-feet/year (afy).
2. *Production/Recovery mode*, which will be at an instantaneous rate of flow of 3000 gpm for the facility as a whole; this is generally anticipated to occur via the pumping of one of the two wells at a rate of 3,000 gpm (ie 4.32 MGD). If the need arises, the recovery may be accomplished by pumping both wells simultaneously at 1,500 gpm each, although this will result in higher operating costs and other potentially undesirable long term effects if practiced regularly. The head conditions for well pump design have been estimated for a hydraulic grade line (HGL) of approximately 529' at the General Jim Moore (GJM) Blvd transmission line immediately adjacent to the facility based on information obtained from Cal-Am. The resulting pumping condition for each of the pumps has been preliminarily estimated at 3000 gpm @ 792' Total Dynamic Head (TDH) at 81% bowl efficiency, which will require a nominal 800 Hp motor. The design recovery season is 7 months, which results in a seasonal production of approximately 2,780 afy.



3. *Idle or Storage mode*, in which the facility neither injects nor recovers water. This period has a design season of one month, however it could be longer depending upon the availability of recharge water. The only anticipated activity during this period is the possible activation of one or both well pumps for collection of aquifer water quality samples; this would require pumping to waste for 1-4 hours on a designated sample collection day.
4. *Backflushing mode*, which will occur on an approximate weekly basis for each well during active injection periods to flush accumulated particulates and biomass from the well bore area. The preliminary design rate for backflushing is 3,000 gpm; flushing will be implemented in a pump-and-surge mode for 1 to 4 hours as determined by well performance trials after construction. Well backflushing discharges will be conveyed to the percolation pit located at the Santa Margarita ASR facility at 1910 GJM Blvd. Only one well will be backflushed at a time, and typical operations will be to backflush one well while the other is in active injection mode.

The P&ID process and controls presented in Sheet I-1 reflect the above operational modes. The process lines for the production/recovery mode are shown in bold/heavy line, whereas the injection and backflushing (and other non-process lines) are shown in normal line weight. Instrument tags are shown in oval boxes with individual tag numbers for each process element. All items associated with ASR-5 are designated in the 500 series of tags, and ASR-6 elements are designated with 600 series tags; this maintains consistency with the existing ASR facilities, ie ASR-1 elements are designated in the 100 series tags, etc. Standard Instrument Society of America (ISA) nomenclature is used for tag prefixes.

Specific elements shown in the P&ID are identified and discussed briefly below.

*P-500 & 600, Well Pump.* These are the main well pump assemblies, and will have the following general features: enclosed tube and shaft assemblies with water flush (not oil lubricated) lineshaft, 12" column, 12" suction with check valve (foot valve), Baski downhole flow control valve assembly (FCV-501/601) with manual nitrogen gas control assembly. This will be similar to ASR 1-4 wells.

*FT-503/603, Well Pump Lube Line Flow Meter & Alarm.* As described above, the well pumps will have enclosed tube & shaft configuration with water flush lubrication. This avoids the numerous problems with oil lubricated well pumps used in ASR operations, while retaining the desirable features of enclosed tube & shaft systems. In order to operate properly, these systems require a minimum of 1.6-2.0 gpm of fresh (potable) water to maintain intermediate shaft bearing lubrication. The flow meters will continually monitor lube water flow, and will alarm and interlock shutdown the well pump if flow drops below setpoint (Interlock I-4). These meters are ½" NPT sized vortex meters with highly sensitive flow capability



and no moving parts that could malfunction. This configuration is identical to the ASR 1-4 wells. Lube water supply originates from the Cal-Am system via a 1" service line connected directly to the main transmission line in GJM Blvd. This water is filtered via a cartridge filter (F-500/600) to prevent any pipe scale or debris from entering the shaft lube assembly, which could impair shaft lube flow.

*VFD 501& 601, Variable Frequency Drive units to feed the P-500/600 motors.* To maintain consistency, these will be Allen Bradley / Rockwell Automation units with identical features to the ASR-1-4 units. The VFD's will be NEMA 1 type, housed in an environmentally controlled building on the ASR-6 site. The units will have Hand-Off-Auto control features, plus Local/Remote actuation from the VFD unit itself (HS 500A/600A) or from the Local Control Panel (LCP) located at each well (HS501/601); this will allow the operator to start/stop the well from the immediate proximity of the well (for backflushing operations) or via the Electrical/Control Building, or via SCADA. The VFD will allow variability of flow and head conditions to address the various operating modes described above, and to compensate for well performance loss due to well plugging and/or aquifer water level declines.

*PRV 502/602, Injection Pressure Reducing Valve.* Pressure control will be needed to maintain a constant injection pressure under the variable system pressures (vis a vis variable system demands) encountered in the Cal-Am system. The valves will be Clavvalve 131 Series externally modulating valves tied to a Clavvalve control module located at each well head; this system will allow local and remote adjustment of injection pressure according to a SCADA or manually input setpoint. This operation will be different than the ASR 1-4 wells, which have Clavvalve 90-03 Series self modulating pressure control valves with solenoid override to close and manual setpoint adjustment features. The change is envisioned to allow greater flexibility in setpoint adjustment , particularly via SCADA – which is not possible at the other wells. This feature is only applicable to the Injection/Recharge mode of operation.

*PSV-505/605, Well Flush-to-Waste Valve.* This valve allows discharges from the well, or from the Cal-Am distribution system to be flushed to the percolation pit at the Santa Margarita site; it will be a Clavvalve 50-03 Series valve with pressure relief and solenoid override to open (flush) functions. The pressure relief feature will serve as a safety to pipeline overpressure from surge or loss of control, and is manually adjusted to setpoint. The solenoid override feature will act as an Open/Shut valve for initial pump-to-waste operations during well production, and as the flush valve in well backflushing operations. The valve can be actuated via SCADA, the local PLC panel, or the individual Local Control Panels at each well. This configuration is identical to those at ASR 1-4.

*FQIT 501/601, Flow Meter.* The main flow meter for injection and recovery operations is a bidirectional rate and bidirectional totalizing meter; to maintain





consistency with the ASR 1-4 sites the meters will be Sparling Tigermag EP meters with local readout and transmitting functions. The output from the meter will be used to monitor and adjust injection flow rate setpoint and as a feedback signal to the well pump VFD's in Recovery and Backflush modes. Flow readout will be visible at the meter/well head, at the facility PLC HMI panel, and via SCADA.

*LT-501/601, Downhole Water Level Transducer.* This transducer will be located within the well casing at approximately the top of pump bowls. It will transmit water level in the well casing in all operational modes. The display information will be visible at the facility PLC HMI panel, and via SCADA, and will be used in the production mode as a permissible signal to allow the well pump to start, as a shutdown signal if the pumping water level drops to within 5 feet (adjustable) of the pump bowls during production and backflushing (Interlock I-1), and in the injection mode to alarm if excessive well draw-up occurs due to well plugging.

*FQI-505/605, Flush to Waste Flow Meter.* ASR operations require flushing to waste under various scenarios; when in the injection mode, initial injection water from the distribution system must be flushed from the lines to remove scale, debris, and stagnant water from entering the well. Once injection operations are in progress, the well must be shut down periodically and pumped to waste to remove accumulated particulate matter and biomass resulting from recharge operations. When in the Recovery mode, initial well flushing is necessary to purge the well of stagnant water and debris originating from flow velocity surges in the well casing. In all of these modes, the waste flow is discharged to the Santa Margarita percolation pit, and the flow rate and total discharge is indicated via the FQI-500 flow meter. This meter is a conventional in-line propeller meter with dial readout of rate and totalizer parameters. It is not a transmitting meter, as Cal-Am operators should be present at all time when flushing operations occur; this configuration is identical to the ASR 1-4 wells.

*DP-100, Percolation Pit (Located off-site at the Santa Margarita ASR facility).* The percolation pit serves as the terminus of all flush waters from all ASR facilities, as neither the Middle School (ASR 3 & 4) nor the Fitch Park (ASR 5 & 6) sites have waste disposal capabilities. The current (2016) capacity of the pit is approximately 245,000 gallons; however it is planned for expansion to 465,000 gallons in 2018. The pit accepts water from the various wells via air gap piping which dumps into an energy dissipater column. Water level is monitored via LT-101, which communicates to the Fitch Park PLC via SCADA; an interlock (I-3) will close the automated flush valves (PSV-500/600) in the event of a high water level.

*PLC-600, Fitch Park facility PLC.* The facility PLC will closely resemble those at the Santa Margarita and Middle School sites, and will control the local equipment at the facility only (the existing PLC's at other sites are Allen Bradley Micro Logix units, model 1769 Compact Logix 1500). The P&ID shows the layering of local vs PLC vs



SCADA hierarchy for the facility. Because the facility is spatially spread out and on two separate parcels, Local Control Panels (LCP's) will be located near the well head on each parcel. The LCP will have essential control functions to allow the operator to start, stop, or adjust functions for that proximate well; these functions include the following:

- Start and stop the well pump (P-500/600) (Note that flow rate will only be adjustable at the facility PLC HMI, not at the LCP's)
- Start, stop and adjust injection flow rate (PRV-502/602)
- Open and close the flush to waste valve (PSV-505/605)

Additional notes in review of the P&ID include the following:

There is currently no Turbidity monitoring of the well production, nor the injection flow; if desired, these can be added as a protection against off-spec water entering the well or the distribution system.

The LCP stations could include additional features, such as speed (flow) adjustment of the well pumps, readout of well casing water level, or readout of the Santa Margarita percolation pit water level; input on these issues is welcomed.

The design currently assumes that the GJM main line will always be 'live' and have a pressure commensurate with the proposed 529' HGL; if the use of the Terminal Storage Reservoir is reinstated and the production/recovery mode returns to a 355' HGL (approximation), then line pressure will be inadequate to supply water to the well lube system, and a Utility Booster Station will need to be added to the facility. This is the existing condition at the Middle School ASR facility.

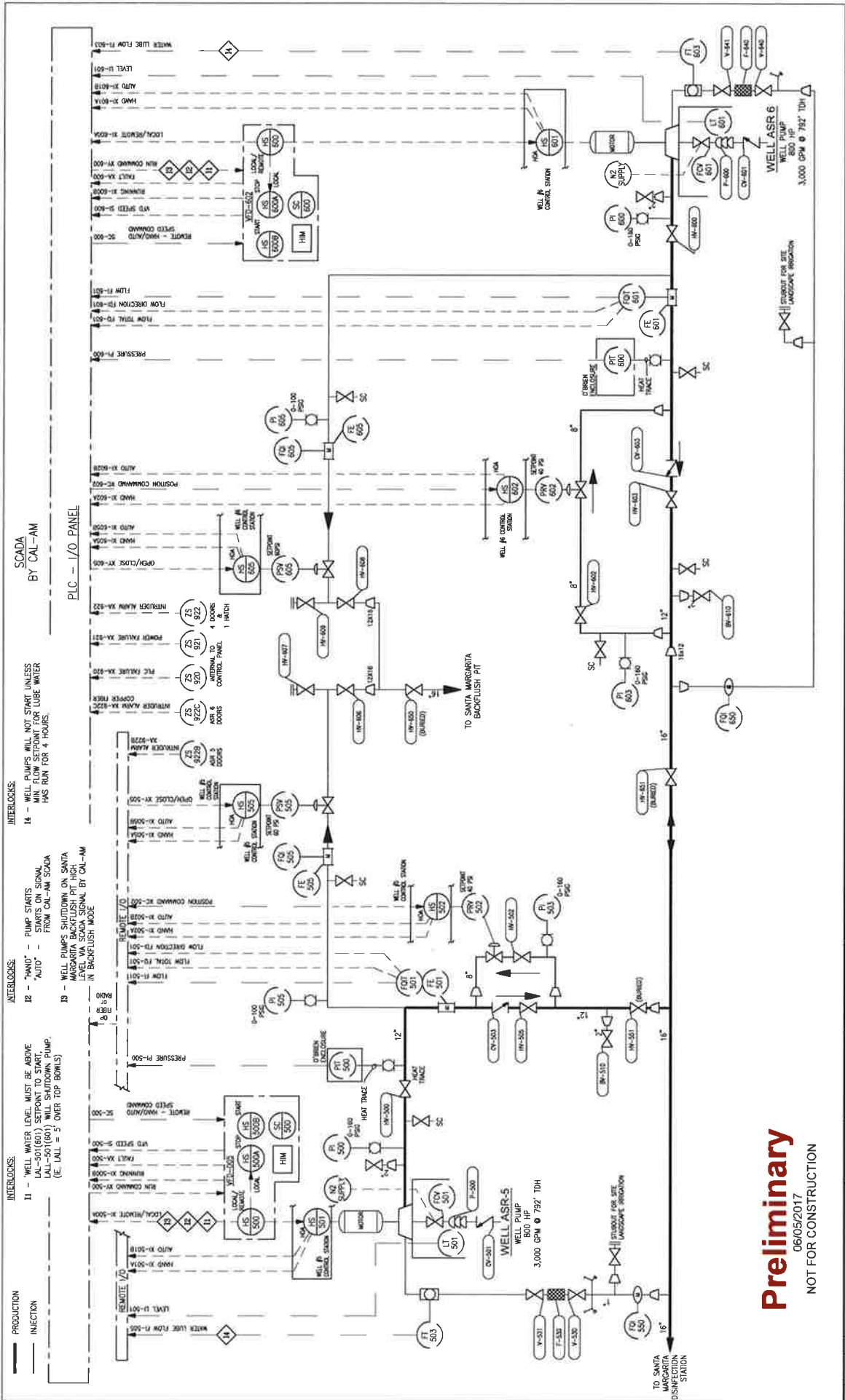

**INTERLOCKS:**

II - "WELL WATER LEVEL MUST BE ABOVE LAL-501(801) SETPOINT TO START LAL-501(801) WILL SHUTDOWN PUMP (E. LAL = 5' OVER TOP BOWLS)

III - "HAND" - PUMP STARTS ON SIGNAL FROM CAL-AM SCADA

IV - WELL PUMPS SHUTDOWN ON SANTA MARGARITA BACKFLUSH PIT IN BACKFLUSH MODE

**INTERLOCKS:**

14 - WELL PUMPS WILL NOT START UNLESS MIN FLOW SETPOINT FOR LUBE WATER HAS RUN FOR 4 HOURS.

**SCADA BY CAL-AM**

PLC - I/O PANEL

**Preliminary**  
06/05/2017  
NOT FOR CONSTRUCTION

PROJECT NO. 20016	<b>PIPING AND INSTRUMENT DIAGRAM</b> CALIFORNIA AMERICAN WATER CO. FITCH PARK SITE ASR 5 & 6 PROJECT
I-1	
UNAUTHORIZED CHANGES & USES CAUTION: The engineer responsible for the design shall be notified of any changes to or use of these plans. All changes to these plans shall be approved by the engineer responsible for the design.	<b>KIVOL ENGINEERING, INC.</b> 3324 Hollister, Santa Barbara, CA 93111 Phone: (805) 861-0940
DESIGNED: RJK DRAWN: MMS CHECKED: RJK	WARNING: IF THIS BAR DOES NOT SHOW UP IN THE DRAWING, IT IS NOT TO SCALE.
SCALE: HOR. 1"=XX' VER. 1"=XX'	PRELIMINARY DESIGN PRELIMINARY DESIGN
REV. DATE: BY:	DESCRIPTION:



May 2017  
 Project No. 15-0132

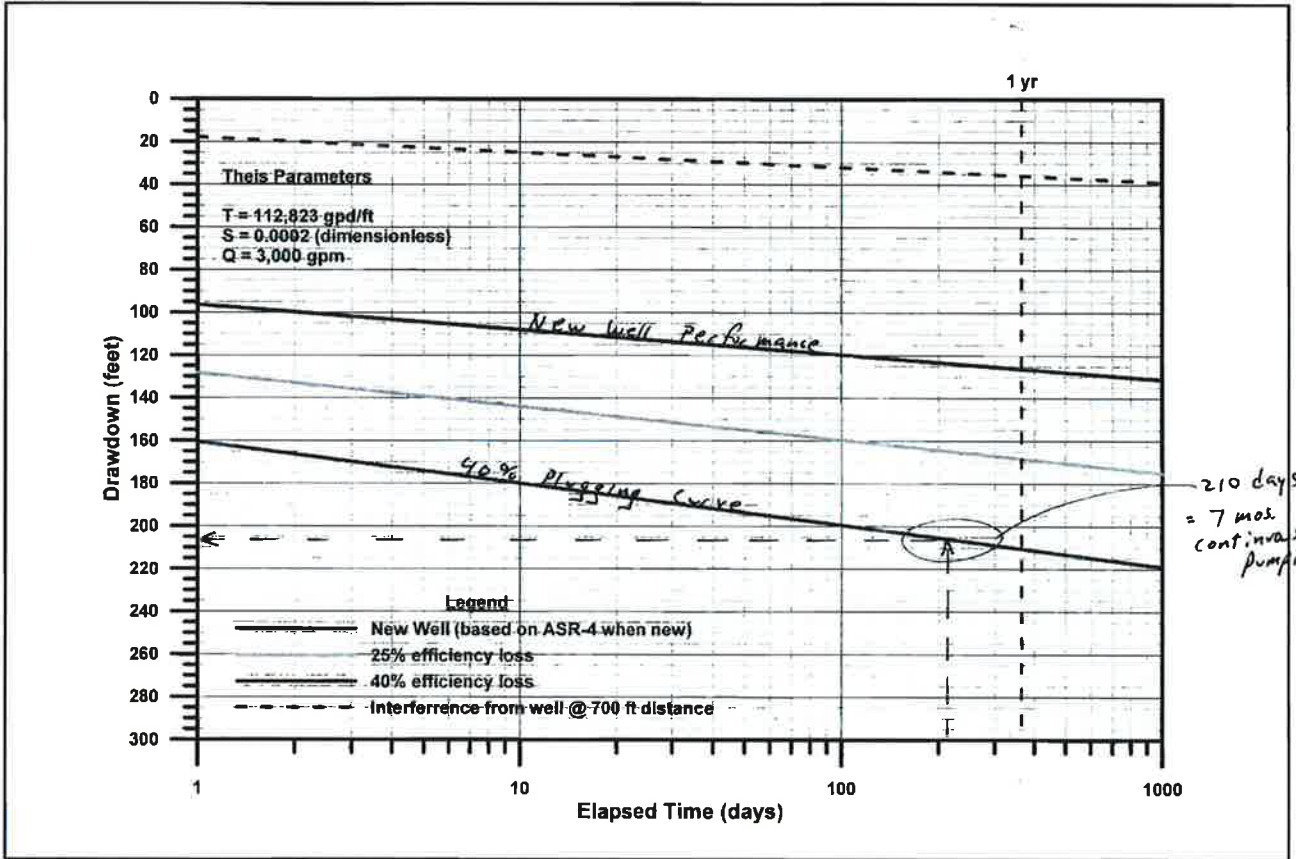
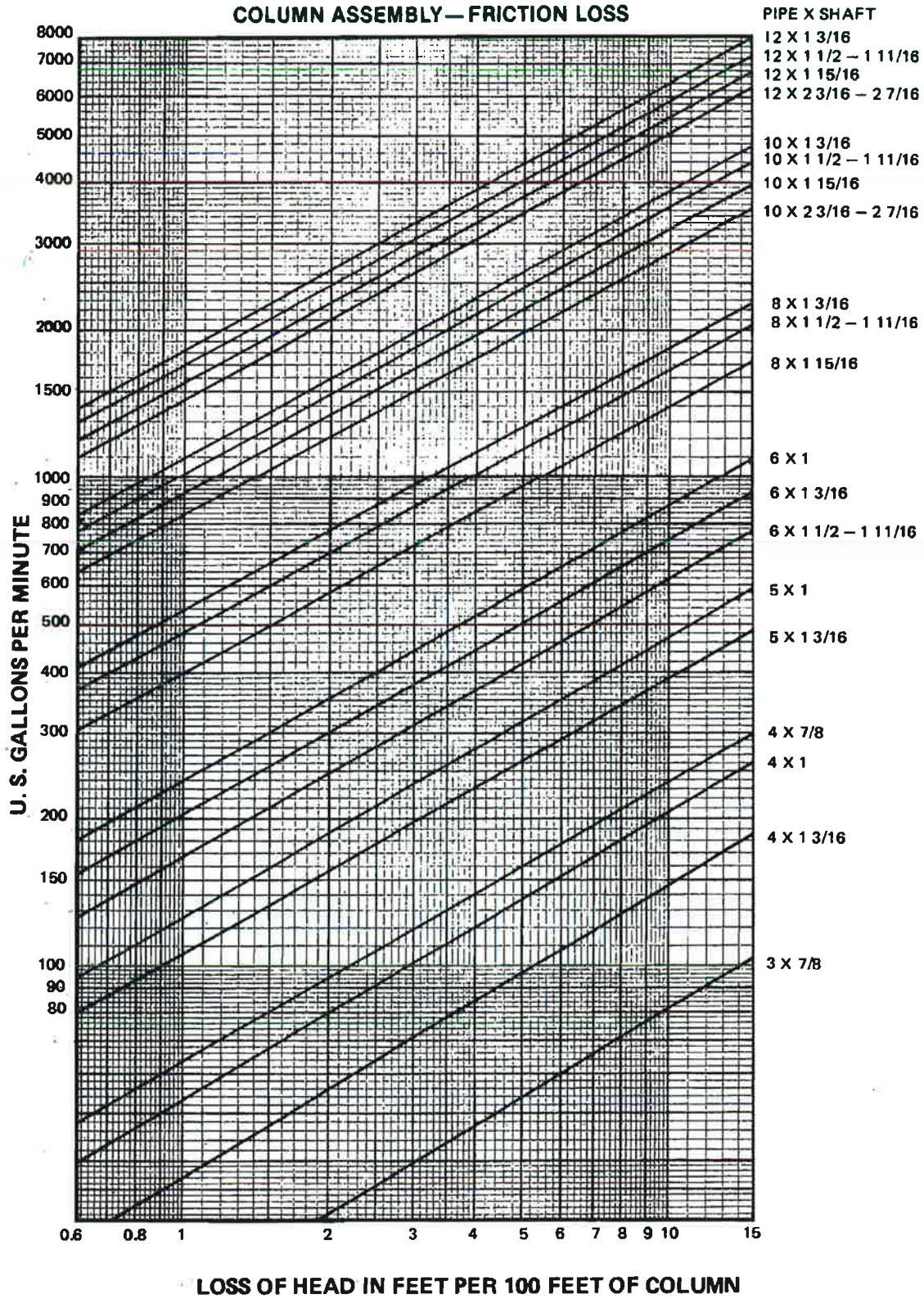

FIGURE 1. THEIS-PREDICTED DRAWDOWN  
 Fitch Park ASR Facility Project  
 California American Water



# COLUMN SELECTION CHART



---

**TECHNICAL MEMORANDUM****Pueblo Water Resources, Inc.**4478 Market St., Suite 705  
Ventura, CA 93003

Tel: 805.644.0470

Fax: 805.644.0480



---

To:	<u>Donald Monette, PE, Project Mgr</u>	Date:	<u>July 27, 2017</u>
Copy to:	<u>Chris Cook, PE, Engineering Mgr.</u>	Project No:	<u>15-0132</u>
From:	<u>Stephen Tanner, PE</u>		
Subject:	<u>Fitch Park Facility: Electrical Service and Electrical Building Issues - <b>DRAFT</b></u>		

As you know, recent discussions have taken place regarding the provision of electrical service to the Fitch Park site from the local electricity provider, Pacific Gas and Electric (PG&E). During the conference call of July 7 with yourself and Messrs. Karl Landis, Bob Kiyoi, Jesus Sanchez, and myself, it was decided that a low voltage service (480 volt, 3 phase) was best suited for the project, mainly due to the need for (portable) standby electrical generator service in the event of emergency (other factors also favored the decision, but this was considered a critical issue). With the low voltage service issue resolved, we performed voltage drop and current capacity calculations to serve the two wells; these calculations addressed two scenarios, (1) a single service drop from PG&E with private (ie Cal-Am) feed of power to both wells sites, and (2) provision of PG&E service at each of the two sites, with separate meter/main and switchgear equipment at each site. Option 2 would necessarily require an electrical building at each site to house this equipment; however, the buildings would be smaller than that which would be required with a single, central electrical building.

As you also recall, we sent a technical memorandum on June 8, 2017 regarding the historical configuration of the Fitch Park ASAR facility, which included a utility and transit corridor between the two well sites. With the current facility configuration having eliminated this direct utility piping corridor, all piping and electrical is now required to traverse the General Jim Moore Blvd right-of-way and then proceed easterly to the well sites; this adds several hundred feet to the electrical power feeds, which was addressed in the voltage drop analysis.

In the assessment of the single vs two electrical service alternatives, we evaluated the electrical, logistical and cost factors associated with each option. The table below summarizes the cost factors for each alternative – and as presented, the costs of each option are nearly the same, with the two-service alternative being approximately \$50,000 less. The primary reason for this is that the cost of electrical cable and conduits for the VFD feeds to each well is exceptionally high,



and because of the distances involved and the associated impedance issues there must be adequate separation of the lines for proper operation.

**Table 1 – Reconnaissance Level Cost Comparison:**

**Central vs Separate PG&E Service for Fitch Park ASR Facility**

Item	Single Service Cost	Separate Services Cost	Comments
<b>Building, complete in place</b>	\$300,000	\$396,000	1 @ 500sf vs 2 @ 330sf ea @ \$600/sf
<b>Meter/Main &amp; Switchgear</b>	\$179,000	\$225,000	
<b>VFD Cable – Single Service</b>	\$71,000	--	2895 Ft. @ 777 kcmil/phase shielded VFD cable
<b>VFD Cable – Two Services</b>	--	\$12,000	500 Ft. @ 777 kcmil/phase shielded VFD cable
<b>4-inch Conduits</b>	\$163,000	\$29,000	500 Ft vs 2895 Ft + pullboxes, etc.
<b>Total Estimated Cost</b>	<b>\$713,000</b>	<b>\$662,000</b>	

The electrical and logistical issues associated with the alternatives include the following:

1. The voltage drop and current capacity of conductors with the associated energy losses are lower with the two service option; in the event of PG&E voltage dips or brown-out conditions, these factors would be exacerbated with a single, central service at one site.
2. With respect to facility reliability and redundancy, the two-service option is clearly superior. If any element of one site failed, whether it be fuses, transformers, air conditioning, or PLC; the other site would not be affected and would remain in service. In addition, the ability to acquire a portable generator will be much more feasible, as the power requirement is more commonly available in generator capacity.
3. Having process lines within GJM Blvd is less desirable from a maintenance standpoint for the obvious reasons of operator safety and logistical complications of traffic control when maintenance activities are required.





Because of the above issues, we recommend that Cal-Am pursue the two-service alternative for the Fitch Park facility. We will proceed with the two-service design with PG&E upon your concurrence with this recommendation.

Subject: Assess Chlorination Station @ Fitch Park

Project: Fitch Park / ASR 5 & 6 Site Development

Client: Cal-Am / Monterey Div.

Project No.: 15-0132 By: S. Tan Date: 9.26-17 Sheet No.: 1 of 1



Basis: - Chlorination for ASR 5 & 6 only

- Prod. Capacity of 3000 gpm (4.3 MGD) from each well
- Design Case: 1 well @ 4.3 MGD Max. Case: 2 wells @ 4.3 MGD
- Facility Basis: 30 days of chem storage w/ 24/7 operation, plus 3 days.

Dose Basis:

Total Feed = Residual + Demand, = 1.5 mg/L Resid. + 0.75 mg/L Demand

\* Both Resid. & Demand are assumed! Actual demand will not be avail. until wells are constructed & tested. Cl demand factors are:

\* Fe: 0.67 mg/mg Mn: 1.4 mg/mg H<sub>2</sub>S: 9-10 mg/mg oxidation w/ HOCl

Dose Est. (from above) using C = DW (#/day)

$$\text{Design: } (4.3 \text{ MGD})(8.34 \text{ #/gal})(2.25 \text{ mg/L}) = 81 \text{ #/day Cl}_2$$

$$\text{Max Case: } (2)(4.3 \text{ MGD})(8.34 \text{ #/gal})(2.25 \text{ mg/L}) = \underline{161 \text{ #/day Cl}_2} = \underline{\text{Max demand/day}}$$

\* If 12.5% HOCl is used, then dosing is

$$\text{Design: } \frac{81}{.125} = 648 \text{ #/d HOCl, @ } 10 \text{ #/gal, or } \frac{648}{10} \approx \underline{65 \text{ gal/day}}$$

$$\text{Max Case: } \frac{161}{.125} = 1291 \text{ #/d HOCl, @ } 10 \text{ #/gal, or } \frac{1291}{10} \approx \underline{129 \text{ gal/day max feed}}$$

Storage Basis:

30 days storage + 3 days buffer,  $\therefore$  33 days vol in main tank

$$\therefore 33 \text{ days @ } 65 \text{ gpd} = 2,145 \text{ gal design}$$

$$\text{and } 33 \text{ " @ } 129 \text{ gpd} = \underline{4,257 \text{ gal max case}}$$

\*  $\therefore$  Tanker Truck delivery needed, assume WB-50 type vehicle

\*  $\therefore$  Storage Tank for 12.5% HOCl  $\approx$  4,000-4500 gal cap.,  $\approx$  10'  $\phi$  x 10'H  
(Polypropylene Const.)

---

**TECHNICAL MEMORANDUM****Pueblo Water Resources, Inc.**4478 Market St., Suite 705  
Ventura, CA 93003

Tel: 805.644.0470

Fax: 805.644.0480



---

To: Donald Robert Monette, Project Mgr Date: October 4, 2017  
Copy to: Chris Cook, PE, Engineering Mgr. Project No: 15-0132  
From: Stephen P Tanner, PE  
Subject: Chemical Storage and Dispensing Issues for Fitch Park ASR Facility **\*\*DRAFT\*\***

In accordance with your recent request, we are providing herein a summary of pertinent design, permitting, and logistical issues we believe will be applicable to the addition of a Chlorination Station at the proposed ASR facilities at the Fitch Park site. We provide this summary as an initial list of pertinent issues to assess the regulatory and logistical applicability of this type of facility; further investigation and confirmation of these areas will be needed as the concept moves forward.

**BACKGROUND**

The Fitch Park ASR Facility as originally proposed included two ASR wells with associated piping, electrical, and instrumentation to allow injection of up to 3000 gpm (4.3 MGD) of treated potable water from the Carmel River watershed and/or the proposed Desalination facility. The facility design also provided for recovery of these waters (plus stored water from the proposed Pure Water Monterey recycled water facility) of 4.3 MGD with the capability of 8.6 MGD (ie simultaneous recovery from both wells) if needed.

State and Federal regulations require the disinfection of these waters upon recovery and conveyance to the potable water distribution system; this disinfection process was originally envisioned to occur at the Santa Margarita ASR Facility located approximately 1 mile south at 1910 General Jim Moore Blvd. This was to serve as the central disinfection point for all recovered ASR waters as it was the most southerly facility in the conceptualized ASR well field.

Since its original planning, other factors have raised the question regarding the feasibility of having an independent Chlorination Station at the Fitch Park facility.

**PRIMARY CONSIDERATIONS**

Disinfection at the Fitch Park ASR facility will need to address several basic needs for a facility of this type. These include the following:



- 1- Cal-Am has standardized on the use of 12.5% Sodium Hypochlorite solution (NaOCl) for its disinfection facilities in Monterey, due to its ease of transport and application, cost, and superior safety considerations (compared to Chlorine gas). It is similarly an appropriate choice of disinfectant for the Fitch Park facility.
- 2- At the Design and Maximum Case production rates, the facility would need a storage volume of approximately 4,000 gallons of 12.5% Sodium Hypochlorite solution for a recommended 30-day supply of chemical. *(Note that the 4,000 gallon storage volume is based on a max production case of 8.6 MGD, having a Free Chlorine Residual of 1.5 mg/L and an assumed Chlorine Demand of 0.75 mg/L. These base numbers may vary significantly (higher) depending on the actual water quality found at the ASR-5 & 6 wells, which will not be constructed until 2018.)*
- 3- Because of the close proximity of ASR-5 and ASR-6 at the site, it would be both logistically and economically preferable to have only one disinfection station serving both wells. Because produced waters from the facility will always flow to the South for conveyance to the Cal-Am system, it is more desirable to have the disinfection point at the more southerly site, ASR-5. (Coincidentally, this is also the only one of the two sites with adequate space and vehicular access to accommodate these facilities.)
- 4- The quantity of chemical needed to supply the facility is too large for individual 55 gallon drums or 275 gallon tote bins to be used; delivery via bulk tanker truck shipment will be needed to supply the facility. Because of this, the facility will need to be sized and designed to accommodate tanker truck deliveries and off-loading of chemicals.
- 5- Although Government Code Section 53091 states that facilities for the storage and treatment of water are exempt from building and zoning ordinances, it is unclear if this applies to properties under the jurisdiction of POM; this should be investigated. Similarly, it should be verified that any CC&R's for the Fitch Park development do not preclude the storage and dispensing of chemicals.

## **DESIGN CONSIDERATIONS**

The following items will need to be addressed in design of the proposed facilities:

- Provision for adequate ingress/egress for 18-wheel semi trailer tanker delivery trucks (WB-50 vehicle configuration or similar). A suitably sized



chemical off-loading pad will be needed as well, with inclusion of chemical spill containment.

- Double containment for bulk chemical storage tanks and piping.
- Dual/redundant chemical injection quills for injection of hypochlorite into produced water lines.
- Chlorine Residual Analyzer instrumentation, including monitoring, recording, and feedback/control loop provisions as needed.
- Separately enclosed chemical storage room/building, of UBC H-7 classification; non-flammable construction, temperature controlled environment (60°-80° F), with no direct accessibility to electrical or pump rooms.
- Storage tank(s), day tank(s), transfer pump(s), and metering pump(s)
- Chemically compatible materials of construction for the building, electrical, and piping components of the facility.
- Ventilation and vent scrubbing to control off-gassing of Chlorine gas from solution.
- Provision of chemical spill control equipment, safety showers and eyewash stations, and appropriate personal protection equipment (PPE) for Sodium Hypochlorite solution.

### **OTHER CONSIDERATIONS**

In addition to the above design and logistical considerations, if the Fitch Park ASR Facility will include chlorination capability, it may be prudent to consider the inclusion of *dechlorination* capability as well. The need for dechlorination of waters occurs periodically in many water systems, and current investigation of water quality issues for ASR operations may result in the recommendation of dechlorination of all waters injected into the Seaside Basin to mitigate undesirable water quality interactions with minerals within the Santa Margarita Sandstone (Tsm) formation. The addition of dechlorination equipment would be relatively straightforward if chlorination capabilities already exist at the site.



## **Appendix 3**

### **Cal Am Electrical Standards**

3.1: Recommended Electrical Design Criteria and Standards

3.2: Power System Study and Arc Flash Analysis Requirements  
Version Date: July 2017

3.3: Acceptable Electrical Equipment Manufacturers and Suppliers

3.4 SEL Device Monitoring Points (Modbus to SCADA (RTU))







AMERICAN WATER

**RECOMMENDED ELECTRICAL  
DESIGN CRITERIA AND STANDARDS**

**AMERICAN WATER BUSINESS SERVICES ENGINEERING**

**March 27, 2018**

# **AMERICAN WATER ENGINEERING RECOMMENDED ELECTRICAL DESIGN CRITERIA AND STANDARDS**

## **INTRODUCTION**

Design of safe, reliable, and cost effective electrical power distribution systems is an essential aspect of the design of water and wastewater pumping, storage, and treatment facilities. Safety begins with proper sizing, coordination, selection, and installation of appropriate materials and power system components, all of which are critical to minimize the risk of worker injury and equipment damage from electrical hazards. Reliability is also tied to proper design and equipment selection because power system components are subject to unique thermal, magnetic, and vibration forces on an often continuous basis. Cost-effectiveness is impacted by numerous design decisions, including equipment location/layout, operating voltage, equipment specifications, design safety factors, environment, etc.

The purpose of this standard is to provide recommendations for electrical system design criteria and standards that American Water Engineering has found to be effective for maximizing value by assuring safe, reliable, and cost-effective electrical power system installations. None of the recommendations included herein shall be construed as superseding local building code requirements, and all facility designs and installations must fully comply with current electrical and building code requirements applicable to the project. In addition, it is the responsibility of the designer to develop a fully integrated and complete set of design plans and specifications based to the degree possible on these design recommendations.

Included with this guidance document are the following three attachments:

1. Attachment A – Power System Studies & Arc Flash Hazard Analysis Requirements. Provides detailed requirements for performing electrical coordination analysis and arc flash hazard assessments. These requirements are considered essential for a complete, coordinated design and should be included as part of a consultant's design scope of services.
2. Attachment B – Acceptable Electrical Equipment Manufacturers List. Identifies acceptable manufacturers for electrical equipment and systems. This listing is to be reviewed with the Owner prior to implementing the design in order to establish preferred sourcing of equipment and suppliers based on Owner preference, service/support and availability. The list is not intended to establish an order of preference; only manufacturers who have demonstrated capability to provide materials and quality of construction for the intended installations and applications. Other sources may be considered if accepted by the Owner in advance of the Design Memorandum submission. Any revisions are to be documented in writing with this submission.
3. Attachment C - SEL Device Monitoring Points (Modbus to SCADA /RTU): Identifies typical data acquired from the various SEL metering and protective relay devices provided on AW Projects. This list is not intended to capture all data that may be necessary nor is intended to limit the actual devices provided.

## **POWER DISTRIBUTION AND ARC FLASH HAZARD CONSIDERATIONS**

Arc flash hazard evaluations have continually shown that the incoming (line-side) terminations on 277/480 VAC and/or 480 VAC services pose significant risk due to high incident energy levels. Frequently, incident energy at the incoming service exceeds 40 cal/cm<sup>2</sup>, or PPE-4 level of protective equipment. To address this issue, AW recommends installing the incoming main service disconnect

device in a separate enclosure, and then sub-feeding from this over-current protection device (OCPD) to a main lug panel or distribution assembly. While this may still pose the risks at this service-entrance location, it is intended that the design and selection of the main device will lower the incident energy associated with the downstream equipment to a level below the PPE-4 maximum protective equipment available for any energized work required.

AW recommends only circuit breakers (no fusible switch equipment) be used for this main service over-current protection device. This allows the operator to “reset” the main in the event of a “trip” incident without having to “open” the equipment (to check fuses, etc.). This “main” should also be provided with the metering input components and devices as outlined herein under item #12 – “Power Monitoring/Metering and Protective Relaying” where this metering is desired by the Owner.

For those facilities where it is intended to also provide permanent or portable standby generator power, the following recommendations should be considered.

1. On 120/208-240 VAC power systems, AW recommends considering the use of circuit breaker transfer equipment in lieu of the individually-mounted “main” circuit breaker and contactor-based transfer equipment (e.g., typical Asco transfer switch). Benefits include combined (but shielded) circuit breakers for the utility and generator protection, UL service-entrance listed as well as UL-1008 listed/labeled for automatic transfer switch (ATS) applications and non-automatic operation associated with portable generator installations. AW has developed a configuration including standard and “optional” features associated with this equipment. The potential for high Incident Energy levels above 40 cal/cm<sup>2</sup> and resulting PPE in these low voltage installations typically does not exceed the PPE available to workers and contractors; the 277/480 VAC Systems are where the highest concerns regarding Incident Energy and “Danger – No Safe PPE Exists” equipment labeling have thus far been determined.

Overall, this circuit breaker type ATS equipment typically represents a lower cost and requires less physical space within the facility providing a cost-effective solution where appropriate and where provided. For those facilities and service areas where contactor-based ATS equipment is already in service, the Owner may elect to continue to provide this type of equipment. However, the features and functions outlined as needed for OCP and Arc Flash Hazard isolation and protection shall be met.

2. On our 277/480 VAC Systems it is recommended to use the separately enclosed “Main” Circuit Breaker to isolate the Utility from the rest of the power distribution system. The use of contactor based ATS equipment requires the use of this separate “Main” as well as an additional “generator circuit breaker” for those applications involving portable generator connections. Additionally, and as a minimum, a shunt-trip interface (i.e. E-Stop control station) shall be provided at the Automatic Transfer Switch (ATS) for disconnection of power associated with any permanently installed generator.
3. Portable standby generator installations offer unique challenges. Many of our portable generators are over-sized for the smaller stations they serve. As such, the OCPD on the generator will typically be larger than the service equipment ampacity ratings in the facility. This is the reason for the “generator circuit breaker” recommended above. Without this additional device, the station equipment is not adequately protected against an over-current event. The shunt-trip device mentioned previously is necessary to “trip” the circuit breaker on the permanently installed generator in order to isolate this power from the building system in the event of an emergency (fire or similar event). The use of the circuit breaker type ATS equipment addresses this concern and is part of the reason AW recommends consideration of this type equipment.

Connection of portable generators is another area which is to be carefully considered. The use of portable generators with large cables and connector bodies poses risks during the installation and connection of these devices to the station. To address this, AW recommends using a color coded pin and sleeve type connector assembly similar to Trystar's Generator Docking Station (complete with cam-lock connections and generator cabling color coded for voltage rating) for those installations 200 Amperes and larger in lieu of the three-phase connector plug and receptacle method. This allows easier and safer connectivity of the equipment by operational staff during an event. In locations where portable generators may be connected for extended periods of time, the transfer switch's control conductors are to be wired to a twist-lock style two-pole grounding receptacle locally mounted near the generator's connector assembly. This will allow the portable unit with remote starting capability to auto-start upon loss of power. Also, where environmental conditions warrant, provide a separate receptacle of suitable voltage and rating for connection of the generator's battery charger and water jacket heater.

## **TECHNICAL CRITERIA AND DESIGN STANDARDS**

### **1. Basic Electrical Materials and Raceways**

- a. All materials shall be suitable for the location and environment where installed. Specifically, AW Engineering has identified the following areas/environments as not being compatible with Stainless Steel (SS) enclosures and supports.
  - 1) Chlorine and chlorinous vapors
  - 2) Fluosilicic acid and vapors
  - 3) Orthophosphate and vapors (zinc orthophosphate, phosphoric acid)
  - 4) Other potential areas and compatibility of materials are to be reviewed with the Owner for final selection of installed systems
  
- b. Control panels and related enclosures in corrosive areas shall generally be non-metallic type with non-metallic hardware; NEMA 12 metallic or non-metallic in non-corrosive areas unless otherwise accepted. The use of stainless steel enclosures should be limited to areas not exposed to chlorine fluoride fumes. Provide NEMA 4X non-metallic enclosures in these and other corrosive areas. It is acceptable to install NEMA 3R enclosures outdoors where the area of installation does not include corrosive atmosphere. VFDs are not recommended to be installed in NEMA 4X enclosures due to issues with localized heating within the enclosure. These enclosures do not have the ability to ventilate using outside air, which potentially overheats the enclosure where a VFD would be installed. It is recommended to install VFDs in NEMA 3R enclosures when installed outdoors and only installed in NEMA 1 or NEMA 12 enclosures when installed indoors in non-corrosive areas. For VFDs installed in corrosive areas indoors, a NEMA 4X enclosure would need to be evaluated to determine if a local mounted AC unit to cool the enclosure is required.
  
- c. All feeders (and branch circuits rated 100 amps and larger) shall be provided in rigid hot-dipped galvanized steel (RGS) or aluminum conduit. The use of fiberglass conduit is an acceptable alternative where approved by the Owner. Other building areas to utilize raceway materials as outlined herein (see 2 below) unless otherwise indicated. Exposed exterior locations may utilize hot-dipped RGS or aluminum conduit where determined suitable for the application. Additionally, the use of fiberglass conduit is acceptable where determined to be suitable for the location and application. The use of intermediate metal conduit (IMC) is prohibited anywhere on the project. The use of electro-metallic tubing (EMT) is prohibited on any Industrial Buildings and Related Type Areas as outlined below.

- d. All conduit fittings to utilize gasketed screw covers; clip cover fastening type fittings are prohibited. Provide "Myers hub" type connectors associated with exterior and wet location enclosures.
- e. Where served from overhead or above, raceway penetrations into buried or below grade equipment / enclosures and exposed exterior equipment enclosures shall not enter the top; they shall enter the bottom side and be provided with a means for draining moisture from the raceway and sealed between the raceway and the enclosure with duct-seal material. These enclosures shall be provided with a vapor corrosion inhibitor (Cortec, or equivalent) sized appropriately for the interior volume of the cabinet.
- f. Receptacles and switches to be heavy-duty rated, 20 ampere minimum rated; material type and configuration to be suitable for the application.
- g. Control Station devices should be NEMA 12 minimum; NEMA 4X rated in corrosive and damp locations where available; all devices to be 30 mm minimum size for gloved operation. All pilot lights are to be high intensity 120 VAC LED type; red for "run", green for "off", amber for "alarm", and white for general indication. Other colors to be coordinated with the Water Company to match existing conventions or as requested; generally in accordance with NFPA-79, Table 10.3.2.

## 2. Raceway Material and General Applications

### a. GENERAL NOTE:

- 1) Raceways are not permitted to be installed concealed in water-bearing walls. All equipment, devices and raceways shall be installed on the dry-side wall surface using nominal 7/8" non-metallic channel support stand-offs installed vertically to allow ventilation air to pass behind equipment and raceways. Fastening hardware to be 316 Stainless Steel or other accepted materials where required due to the environmental conditions of the area
- 2) No raceway is permitted to penetrate the floor or wall into the containment area of a chemical room. Note: final connections and raceway installations serving equipment located within this containment zone shall be supplied from outlets and equipment enclosures mounted above the maximum containment level identified. All penetrations, outlets, and equipment are to be located above the containment zone in the room. This prevents a failure of the raceway system from potentially becoming a "drain".

*The following general criteria are to be used for raceway material selection and installations. This listing is not intended to address all applications and/or specific equipment requirements which may be outlined elsewhere on the Engineer's Drawings or indicated in the Specifications.*

### b. Industrial Buildings and Related Type Facilities or Areas:

#### 1) Chemical Storage and Dispensing (non-hazardous materials)

##### i. Exposed from Finished Floor to 8'-0" AFF

- a. PVC Coated rigid galvanized steel (RGS) Conduit and Liquidtight Flexible Metal Conduit are recommended. PVC Schedule 40 Conduit and Non-Metallic Liquid-tight Flexible raceways may be used in areas where not subject to physical damage from O&M activities such as chemical deliveries or vehicular traffic.



- i. Alternate Materials: the selective use of fiberglass conduit provides another means of addressing corrosion resistance and maintaining a non-metallic installation. [Note: AW Engineering does not recommend the use of PVC conduit, even Schedule 80 PVC where subject to physical damage
    - b. Outlet and Junction Boxes - PVC Coated, Cast Type, FD capacity for use with the PVC Coated RS Conduit. As above, where non-metallic raceways are utilized, the use of non-metallic outlet and junction boxes may be provided.
    - c. All outlet cover plates to be "in-use", weather-protected type and gasketed.
  - ii. Exposed 8'-0" AFF and above within the room
    - a. PVC Schedule 40 Conduit may be used in lieu of PVC Coated RS Raceways. Where provided, the Contractor shall include the use of expansion and axial connectors as recommended by the non-metallic raceway Manufacturer (not just at building expansion points).
    - b. Junction Boxes - PVC, FD capacity for use with the PVC Conduit System.
  - iii. *NOTE: No "in-floor" conduit or floor penetrations are permitted within chemical containment areas.*
  - iv. As above, the use of fiberglass conduit systems is permitted to be used in place of the PVC Coated RGS raceways and PVC Schedule 40 Conduit hybrid systems outlined above as well as other locations throughout the facility. As above, no penetrations within the chemical containment areas are permitted.
 

*Engineers NOTE - Potentially, a listing or some other form for identifying which chemicals / areas require the use of seal-offs will need to be determined and included in the Contract Documents (below)*
  - v. Transitions from Chemical Storage and Dispensing Areas to other building areas shall utilize PVC Coated RS Conduit within the area and transition to RGS material where extending to a non-chemical area. Provide seal-off fittings and appropriate sealing material (as specified) to prevent vapor transmission through the raceway system at this transition point inside the chemical area.
- 2) "Damp" Areas, including those areas involving enclosed tanks and piping, but do not involve direct wash-down or similar use of water, and where the ambient temperature of the space may drop below 65 degrees F.
  - i. Rigid Galvanized Steel (RGS) Conduit and fittings.
  - ii. Liquidtight Flexible Metal Conduit.
  - iii. Exposed outlets - Cast Type, FD capacity.
  - iv. Recessed Outlets (where permitted) - one-piece galvanized steel (expandable metal outlets not permitted).
  - v. Cover plates – stainless steel or cast cover type or as specified and/or indicated on the Drawings.
- 3) "Wet" Areas, including those areas involving exposed/open tanks and direct wash-down and similar applications, where water is routinely present.
  - i. Rigid Galvanized Steel (RGS) Conduit and fittings or PVC Coated RGS Conduit and PVC Coated fittings as indicated on the Drawings.

- ii. Liquidtight Flexible Metal Conduit.
- iii. Exposed outlets - Cast Type, FD capacity (PVC Coated where coated raceway systems are indicated on the Drawings).
- iv. Recessed Outlets (where permitted) - one-piece galvanized steel (expandable metal outlets not permitted).
- v. All outlet device cover plates to be "in-use", weather-protected and gasketed type.

*Engineers Note - "Damp" and "Wet" terms will need to be defined and included in the Contract Documents.*

*Owner's Note – AWBSE has found metallic raceway systems provide higher reliability and longevity than PVC systems, but Owner may consider the use of non-metallic raceway systems on projects involving limited conduit lengths and where risks for damage to raceway is considered minimal.*

#### 4) Electrical, Mechanical (HVAC) and General Equipment Storage Rooms

- i. Rigid Galvanized Steel (RGS) Conduit and fittings.
- ii. Flexible Metal Conduit - Lighting Fixtures and similar type equipment.
- iii. Liquidtight Flexible Metal Conduit - motor (and similar equipment involving close proximity to water and/or oil) connections.
- iv. Exposed outlets - Cast Type, FD capacity.
- v. Recessed Outlets (where permitted) - one-piece galvanized steel (expandable metal outlets not permitted).
- vi. Cover plates - companion type as specified and/or indicated in Specifications or on the Drawings.

#### 5) Hangers, Supports and Fasteners

- i. In chemical and corrosive areas, FRP Threaded Rod with non-metallic FRP channel supports and fasteners shall be provided. In areas other than Chlorine and Fluoride environments, the use of 316 Stainless Steel threaded rod and fasteners also is permitted. Where the weight of the installation exceeds that permitted by the FRP materials, the use of 316 SS channel supports and threaded rod will be considered acceptable. PVC Coated steel channel supports is not accepted.
- ii. In all other areas channel supports shall be hot-dipped galvanized and threaded rod shall be galvanized steel. All fasteners shall be 316 Stainless Steel.

#### 6) Cable Tray and Trough Systems

- i. The use of aluminum or FRP cable tray is an acceptable practice for wiring of equipment; especially in pipe galleries, alongside of walkways and similar tight areas where access to equipment is very restricted.
- ii. Solid-bottom (or ventilated bottom) cable trough systems are also considered acceptable for locations where ladder type cable tray is not appropriate due to special considerations of the work.
- iii. The use of cable tray and / or trough systems is to be reviewed with and accepted by the Owner prior to the start of design. The Design Memorandum shall include a description of what is being proposed and wiring systems to be included.
- iv. Cable types to be UL Listed for the applications and isolation between voltages, including low voltage and instrumentation systems shall be included in the design.

c. Administrative Buildings and Related Type Facilities or Areas

1) All areas within conditioned rooms (those spaces where heating and/or air conditioning/ventilation is provided to maintain a nominal ambient temperature of 68 degrees and higher).

2) General Installations

- i. Conduits 1-1/4" and smaller may be EMT. This raceway type may be provided for either exposed or concealed raceways. All EMT connectors and fittings shall be compression type only (the use of set-screw fittings is NOT permitted)
- ii. Rigid Galvanized Steel (RGS) Conduit and fittings shall be used for all raceways 1-1/2" and larger.
- iii. PVC Conduit is NOT to be used for any application other than for approved in-floor (or other encased in concrete) applications as outlined elsewhere in these Documents.
- iv. Flexible Metal Conduit - Recessed Lighting Fixture connections and similar type equipment terminations. Alternatively, the use of MC Cable is permitted for lighting fixture installations where determined acceptable by the Owner.
- v. Liquidtight Flexible Metal Conduit is to be used for motor and transformer terminations as well as other equipment where vibration and/or access is required that would otherwise be impeded by a fixed raceway installation. Connections are to utilize stainless steel fittings; PVC Coated where installed in chemical and corrosive atmospheres
- vi. Exposed outlets - Cast Type, FD capacity.
- vii. Recessed Outlets - one-piece galvanized steel (expandable metal outlets not permitted).
- viii. Cover plates - companion type as specified and/or indicated on the Drawings.

3) In-floor (or other encased in concrete) Installations

- i. PVC Schedule 40 for 120 volt and greater general power / branch circuits; transition to metallic or fiberglass raceway system for continuation in or on wall as identified above. (Note - refer to VFD cabling installation requirements for special installation considerations).
- ii. EMT for Data, Instrumentation and low voltage signal (less than 50 V) circuits; maintain metallic raceway system for continuation in or on wall as identified above.
- iii. All conduits embedded in concrete floor to be compliant with ACI-318 criteria for minimum embedment and spacing requirements to assure structural integrity of structure.
- iv. All transitions from "in-floor" to above floor in any area or room where water is also supplied in the room shall utilize PVC Coated RS Conduit sweeps to provide corrosion / physical protection; extend PVC Coated raceway minimum 6" AFF. Alternatively, the use of fiberglass raceways may be accepted if approved by the Owner. No transitions to be installed where raceway penetrates floor finish on an angle of the radius.

d. Underground and Similar Raceway Applications

1) Encased in Concrete Raceway Installations - (Ductbanks, Equipment Bases, etc) as identified on the Drawings

- i. Minimum size conduits for underground installation to be 1".



- ii. Conduits smaller than 2" in diameter - PVC Schedule 40 Conduit with PVC Schedule 40 sweep radius horizontal bends and PVC Coated RS raceway sweep radius bends for vertical transitions to above grade or concrete surface.
  - iii. Conduits 2" in diameter and greater - PVC Schedule 40 Conduit with RGS or fiberglass sweep radius horizontal bends and PVC Coated RS Conduit sweep radius bends for vertical transitions to above grade or concrete surface.
  - iv. Alternative use of fiberglass raceways is acceptable where approved by the Owner for those underground horizontal and vertical transitions to above grade or floor / concrete base.
  - v. Note - Refer to VFD cabling installation requirements for special installation considerations that may alter the criteria outlined above.
  - vi. Conduit supports, spacing and concrete / reinforcement to be as specified.
- 2) Direct Burial Raceway Installations - Ductbanks, Branch Circuits and Feeders as Identified on the Drawings
- i. Conduits smaller than 2" in diameter - PVC Schedule 40 Conduit with PVC Schedule 80 sweep radius horizontal bends and PVC Coated RS raceway sweep radius bends for vertical transitions to above grade or concrete surface.
  - ii. Conduits 2" in diameter and greater - PVC Schedule 40 Conduit with RGS sweep radius horizontal bends and PVC Coated RS Conduit sweep radius bends for vertical transitions to above grade or concrete surface. .
  - iii. Alternative use of fiberglass raceways may be considered acceptable where approved by the Owner for those underground horizontal and vertical transitions to above grade or floor / concrete base.
  - iv. Note - Refer to VFD cabling installation requirements for special installation considerations that may alter the criteria outlined above
  - v. Conduit spacing and protective concrete cover to be as specified below or as detailed on the Drawings. Note, Direct Burial installations do not use conduit "chairs" or separators; embedment is provided by screening material only.
  - vi. Provide 5" thick concrete protective pour with 10 x 10 WWF over top of screening backfill for physical protection and vehicular wheel loading. Where crossing roadways or drives, conduit work to be reinforced, concrete encased as in #d.1 above; extended a minimum 10' on either side of pavement.
  - vii. Transitions from underground to building or other structure to be provided as detailed on the Drawings
- e. Special Applications and Locations:
- i. Wastewater installations rating to be established by NFPA 820 and installations in compliance with Article 501 of the NEC
  - ii. Hazardous locations where determined are to be installed in accordance with the NEC while addressing the use of corrosive-resistant materials as outlined above. Provide raceway seal-offs and fire seals as required by Code. Additional raceway seal-offs to be provided to prevent the migration of corrosive vapors from a chemical area into an adjoining area and sealed with a non-water soluble compound material

### 3. Lighting Systems

- a. Indoor Locations:
  - 1) Fluorescent lighting systems are typically considered very cost-effective and suitable for all interior applications; fixture types and source control as outlined in Appendix B.

These systems allow for component replacement and enclosure types to address any normal application or location. Based on AWBSE and Manufacturer data, the proper selection of lamp, ballast and control components has shown long term life-cycle and maintainability benefits.

- 2) The use of LED lighting sources and devices has become more popular in recent time as their costs have become more competitive with other systems. As a result, AW Engineering recommends an initial evaluation be considered to address initial costs as well as maintainability of the systems. These systems are to be considered and used upon approval from the Owner and after review of the life-cycle costs associated with total installations. The Engineer shall identify and provide all information regarding potential rebates, off-setting cost programs, etc. available for the use
  - 3) Night-lighting / means of egress lighting fixtures shall be incorporated in the normal lighting layout / scheme to ensure that all passages and exits remain illuminated in the event of a power failure. These fixtures may be switched in areas where required providing they include the lighting transfer device integral with the fixture. (i.e... training and AV presentation areas, operational control rooms, etc.). This pass-thru/night lighting should be otherwise be un-switched; other lighting in the area or room to be controlled by means of suitable occupancy sensors
  - 4) Separate battery-powered emergency lighting units shall also be provided to augment this night-lighting system and provide Code required means of egress lighting in the event of a power failure of the Utility and/or Stand-By Power System. Provide a remote battery-controlled lamp on the exterior of building exit doors connected to the interior unit to provide illumination away from the building. These units are to be powered from the local area night-lighting circuits and wired ahead of any switching. . All emergency lights, including outdoor remote head, are to be provided with twin lamps so failure of one lamp does not leave area in total darkness
  - 5) Lighting fixtures types are to be suitable for the environments where installed and shall be located (serviceable and accessible) for routine maintenance. Provide calculations and fixture catalog data/specification sheets for review and acceptance by the Water Company.
- b. Outdoor Locations:
- 1) The use of LED type lighting fixtures shall be used in the design for the exterior of the building; HID lighting (HPS) shall be an acceptable alternative for exterior use where providing similar type to match existing. Illumination levels to be as recommended by IES for the space and tasks being performed.
  - 2) Wall mounted lighting units to be coordinated with AW Security Group for illumination of areas where specifically required.
  - 3) Pole mounted fixtures to utilize tapered aluminum poles; height as required to meet lighting illumination levels in area. Pole heights and locations to also address maintainability issues for Owner replacement and repair.
  - 4) Outdoor lighting design is to comply with local ordinances for trespass lighting, up-lighting, pole height, and additional requirements the AHJ may have for the installation location

- c. Where otherwise required by the authority having jurisdiction , provide means of egress and emergency lighting systems in conformance with NFPA 101 (the Life Safety Code)
- d. Illuminated Exit Signs: IF REQUIRED by CODE, provide LED type and placed inside the facility per the latest requirements of NFPA 101 (the Life Safety Code) as applicable. Otherwise, provide non-illuminated, non-metallic exit signage for general egress direction and identification as determined by the engineer/architect and/or building official.

#### 4. Cables

##### a. Low Voltage Wire and Cable:

- 1) All conductors to be copper
- 2) Those rated for 480V and below shall be listed as XHHW-2 for general underground, damp and wet locations and other similar areas. In addition, only XHHW-2 insulated conductor material is to be used with any variable frequency drive application.
- 3) Dual-rated THHN/THWN type is for use ONLY in interior, (*Administrative Buildings and Related Type Facilities or Areas as previously defined*) dry locations. *[NOTE: on projects involving multiple environmental conditions, AW has found that allowing both types of insulation has often resulted in field errors of the wrong type wire being installed. As a result, AW Engineering recommends using the Type XHHW-2 insulated wire throughout the project to eliminate this situation.]*
- 4) Insulation shall be UL listed for at least 90 degrees centigrade but applied at its 75 degree ampacity rating (maximum). Provide specific information in the Documents outlining where each type of conductor insulation material for review and acceptance by the Water Company
- 5) Multi-conductor, Tray Rated Cable to be provided for cable tray applications as outlined. All cables to be 600 volt insulated, 90 °C rated / applied at 75 °C ampacity rating. In general, provide;
  - i. Type A – XHHW-2 (XLP) insulated conductors with ICEA Method E-1 or E-2 color coding; note this info on the Drawings. Cable to have PVC outer jacket. Uses include power and control devices.
  - ii. Type B – THHN/THWN-2 with black insulated conductors with white printed numbers, #14 AWG, number of conductors as required; PVC overall jacket. Uses include control / monitoring interface with SCADA/RTU equipment and field devices
  - iii. Other types and specific color coding to be provided based on voltage application for power conductors and control wiring for interface with SCADA/RTU equipment in accordance with AW Standards for these applications.
- 6) VFD Cables
  - i. Acceptable Manufacturers (included herein to identify basis of material design for these special cables) Refer to AW Acceptable Manufacturers List for additional/supplemental information:
    - a. Belden 29 Series (600VAC Rated Cable); wire gauge as indicated on the Drawings
    - b. AmerCable, Inc. – CIR Type (600VAC Rated) VFD Power Cable Gexol Insulated; wire gauge as indicated on the Drawings.

- ii. Description: Three-conductor plus ground with cross-linked polyethylene or polyolefin listed insulation with fully-rated and identified equipment grounding conductor(s); 90 degree C listed for Wet or Dry applications with outer PVC jacket.
  - iii. Conductor: Tinned-Copper, multi-conductor cable, size as indicated on the Drawings.
- b. Medium Voltage Cable:
- 1) Provide Type MV-105 shielded medium voltage cable for all normal power and feeder installations unless specifically required otherwise by the serving Utility Company for materials associated with a medium voltage service entrance installation.
  - 2) For medium voltage motor installations, provide shielded conductors (Type MV-105) along with means for terminating the cable shields (and bonding to the equipment grounding conductor) before entering the motor termination box on the motor.
  - 3) All conductors to be copper.

## 5. Grounding

- a. General - Unless otherwise indicated or required, all facility installations shall utilize grounded power distribution systems. Normally, all will be solidly-grounded; provide resistance-grounded systems only where determined to be required for equipment and/or life-safety protection.
- b. The electrical system and equipment grounding is to be in compliance with the National Electrical Code. A buried grounding grid or counterpoise is to be provided for the new switchgear equipment, transformers and standby generators.
- c. Conductors shall be No. 2 AWG stranded copper (minimum) for interconnecting ground rods and for connection to transformers and MCC's and other major electrical equipment. All connections to this underground earthing system shall be made using exothermic weld process. Connections to reinforcement steel in foundations shall utilize hydraulic compression fittings. Bolted connections shall only be provided where accessibility and temporary removal for testing is required. All electrical equipment shall be bonded to the grounding system including motors, transformers, panelboards, other equipment, metal stairs / ladders, etc. and metallic raceway systems. All conduits containing power and control wiring shall be provided with a separate "green" grounding conductor; use of the raceway system as a sole means of grounding is not permitted.
- d. Provide test well for grounding system testing at main service bonding to ground rod and other locations as determined appropriate by the Owner. Ground test well to be minimum 12' x 12" with tamper-resistant stainless steel bolted cover and "Ground" cast into the cover plate.
- e. Increased conductor sizing to be as required by Code and/or grounding calculations where associated with switchgear substations and lightning protection system installations.
- f. Instrumentation Grounding – review and provide grounding associated with the special requirements for this system.

## 6. Medium Voltage Equipment

- a. The following criteria apply to 5 KV – 15 KV maximum installations (*higher voltage applications to be coordinated with AWBSE*).
  - 1) AWBSE recommends the use of dry-type transformers over liquid-cooled units to avoid potential environmental concerns and risks as well as reduced maintenance requirements and associated O&M costs. Our preferred equipment uses cast-coil, epoxy encapsulated windings on the primary and secondary windings. Other possible solutions involve the use of VPE insulated assemblies which provide a higher degree of protection over the standard VPI insulated units.
  - 2) The use of liquid-cooled units is generally only recommended where transformers are needed for 5 MVA and larger service applications; the type and associated ratings, cooling capabilities and auxiliary features and appurtenances to be coordinated with Utility and Owner criteria as outlined in the RFP for the project.
  - 3) Provide alarm monitoring for reporting to the process control system and include provisions for forced air cooling were appropriate
  - 4) All transformers are to utilize copper winding material – primary and secondary coils.
- b. Medium Voltage Transformers
  - 1) Type of Equipment: Plated copper bus as determined suitable for the installation/location and environmental conditions, 3-phase, 3-wire plus ground operating at 60 Hz. Utilize draw-out vacuum circuit breakers and/or fusible type switchgear assemblies where specifically identified in the RFP. All components are U.L. listed. Switchgear equipment shall consist of standardized, freestanding structures bolted together for form a single dead-front panel assembly containing circuit breakers, control devices, protective relay and metering units and all interlocking and miscellaneous control / interface devices.
  - 2) Fusible sections (where applicable) to be configured from left to right; use of front to back fuse arrangements are not permitted.
  - 3) Protective relaying and/or metering to be as outlined in #12 below. Relay coordination settings and ratings to be selected by the Engineer based on the Protective Coordination and Arc Flash Hazard analysis outlined in Attachment A
  - 4) In general, Metal-Enclosed Switchgear is considered acceptable. Provide Metal-Clad Switchgear type design where required or indicated or otherwise due to specific design and/or Utility considerations.
- c. Medium Voltage Switchgear
  - 1) Type of Equipment: Tin-plated copper bus (phase and ground), 3-phase, 3-wire plus ground operating at 60Hz. All components are U.L. listed. MCC equipment shall consist of standardized, freestanding structures bolted together for form a single dead-front panel assembly containing combination vacuum contactor motor controller units; feeder units; metering, relaying, and interlocking and miscellaneous control devices. Provide magnetically-held or mechanically latched type of vacuum contactor controllers as required for the application or equipment served.
  - 2) Fusible sections to be configured from left to right; use of front to back fuse arrangements are not permitted. Fuse types and ratings to be selected by the Engineer based on the Protective Coordination and Arc Flash Hazard analysis outlined in Attachment A
  - 3) Starters:
    - i. Full-Voltage or Reduced Voltage NEMA rated fusible switch / contactor type combination controllers as outlined in the RFP or otherwise determined by the Engineer and Owner. The use of IEC rated controller is prohibited.
- d. Medium Voltage Motor Controllers
  - 1) Type of Equipment: Tin-plated copper bus (phase and ground), 3-phase, 3-wire plus ground operating at 60Hz. All components are U.L. listed. MCC equipment shall consist of standardized, freestanding structures bolted together for form a single dead-front panel assembly containing combination vacuum contactor motor controller units; feeder units; metering, relaying, and interlocking and miscellaneous control devices. Provide magnetically-held or mechanically latched type of vacuum contactor controllers as required for the application or equipment served.
  - 2) Fusible sections to be configured from left to right; use of front to back fuse arrangements are not permitted. Fuse types and ratings to be selected by the Engineer based on the Protective Coordination and Arc Flash Hazard analysis outlined in Attachment A
  - 3) Starters:
    - i. Full-Voltage or Reduced Voltage NEMA rated fusible switch / contactor type combination controllers as outlined in the RFP or otherwise determined by the Engineer and Owner. The use of IEC rated controller is prohibited.



- ii. Solid-state reduced voltage motor starters shall be utilized where required due to power utility requirements, process control of hydraulic transients, and/or engine-generator sizing considerations.
- iii. The Engineer shall coordinate starter types with the Water Company.
- 4) Control power – provide each starter with individual 120 VAC CPT rated for minimum 100 VA above that required for loads served; min 150 VA. CPI's to be fused on primary and secondary.
- 5) Control devices – provide minimum 30 mm diameter devices for all control switches, push buttons and pilot lights. Pilot lights to be high intensity, 120 VAC LED type; color as outlined herein or otherwise required by Owner.
- 6) Protective relaying and/or metering to be as outlined below. Relay coordination settings and ratings to be selected by the Engineer based on the Protective Coordination and Arc Flash Hazard analysis outlined in Attachment A.

## 7. Low Voltage Motor Control Centers/Motor Controllers

- a. Type of Equipment: Tin-plated copper bus (phase and ground), 600V, 3-phase, 3-wire plus ground operating at 60Hz; provide a neutral bus (3-phase, 4-wire plus ground applications) only in those MCC assemblies where required. All components are U.L. listed. MCC equipment shall consist of standardized, freestanding structures bolted together for form a single dead-front panel assembly containing combination motor control units; feeder units; metering, relaying, and interlocking and miscellaneous control devices and will be of the per definitions in the latest edition of NEMA ICS 3 and UL 845.
- b. Starters:
  - 1) Full-Voltage NEMA rated (Size 1 minimum) combination magnetic starters shall be utilized as required. The use of IEC rated starters is prohibited.
  - 2) Solid-state reduced voltage motor starters may be utilized where required due to power utility requirements, process control of hydraulic transients, and/or engine-generator sizing considerations.
  - 3) The Engineer shall coordinate starter types with the Water Company.
- c. Circuit Breaker Compartments and Circuit Breakers: Control center disconnects shall be three-pole, single-throw, 600-volt, molded-case circuit breakers
  - 1) Feeder and branch circuit breakers to be thermal-magnetic or solid-state trip type as required for the loads served, protective coordination and arc-flash hazard considerations.
  - 2) Circuit breakers associated with combination starters shall be magnetic motor circuit protector (MCP) type where appropriate.
  - 3) All shall be manually operated with quick-make, quick-break, trip-free toggle mechanism.
- d. Control power – provide each starter with individual 120 VAC CPT rated for minimum 100 VA above that required for loads served; min 150 VA. CPT's to be fused on primary and secondary
- e. Control devices – provide minimum 30 mm diameter devices for all control switches, push buttons and pilot lights. Pilot lights to be high intensity, 120 VAC LED type; color as outlined herein or otherwise required by Owner.
- f. Protective relaying and/or metering to be as outlined in #12 below. Relay coordination settings and ratings to be selected by the Engineer based on the Protective Coordination and Arc Flash Hazard analysis outlined in Attachment A.

- g. VFD Installations – while not recommended, where VFD's are required to be installed in MCC type construction, locations and general arrangements to address ventilation requirements of equipment. These installations typically will necessitate use of NEMA 1 configurations to avoid undue costs for the overall assembly; special attention to this is required to coordinate the design. Where it is determined NEMA 12 (or NEMA 4X) is necessary, VFD's shall not be included in MCC type construction.
- h. Enclosure Type: Typically NEMA 1 is acceptable for conventional MCC construction utilizing only starters and circuit breakers. Match existing NEMA ratings in equivalent areas of the plant. Engineer shall also propose modifications to the NEMA rating if appropriate for intended service.

## 8. Variable Frequency Drives (VFDs)

- a. In general, 6 pulse VFDs with line reactors are to be used for motor loads 50 HP and smaller. On motors greater than 50 HP but less than 100 HP evaluation of drive type to be determined based on base load versus non-linear loading. On all drives where harmonics at the Owner's equipment bus is potentially determined to be greater than 5% TDD. Provide VFD with passive or active harmonics filter / line conditioning unit.
- b. In general, 18 pulse VFDs are to be used on motors 100 HP and larger. However, final determination from harmonics analysis and evaluation of linear versus non-linear loading is to be taken into account in making final selection. Harmonics at the Owner's equipment is to be below 5% TDD. Provide harmonics filtering / line conditioning as required to meet these criteria.
- c. For motor applications involving long cable feeders between the VFD and the motor (e.g., ~100'+ or as defined by manufacturer), provide dv/dt output filters based on VFD and motor criteria for selected equipment.
- d. VFD's installed in damp locations to be provided as NEMA 12 type equipment; those installed in locations such as dedicated electrical equipment rooms may be NEMA 1 type. However, all drives to be provided with door filter units mounted on exterior for access where possible.
- e. All VFDs shall be rated as Industrial Duty / Heavy Duty type and be rated for a 50 °C ambient location. The use of 40 °C rated equipment and "HVAC" rated VFDs are not permitted.
- f. Unless specifically accepted, all VFDs shall be stand-alone enclosed, wall or floor mounted equipment; do not combine in common enclosures or MCC construction.
- g. VFDs shall be provided with Bypass starters where outlined in the RFP. Bypass starter type and rating to be as outlined; FVNR or RVSS types are typically required based on starting and hydraulic concerns in the system.

*Note: Ventilation / Air Conditioning – AWBSE recommends ventilation air be used as the primary means of cooling for VFD applications and installation locations. The use of Air Conditioning (A/C) is not typically required in most geographic locations. Where A/C is determined to be necessary, the units shall be provided with an economizer mode which uses outside air as the first stage. Additionally, ventilation system should be designed to withdraw heat from above VFD enclosures and introduce cooling air near lower air intake section of VFD.*

## 9. Miscellaneous Power Distribution:

- a. Panelboards and Switchboards: Circuit breakers will be of the "Bolt-On" type;"Push-On" / "Plug-On" type circuit breakers are not allowed. Use plated copper bus and ensure U.L. labeling of entire system.
- b. Provide a Surge Protective Device (SPD) on the main of each power distribution panel where applicable. In addition, provide an SPD on panels serving sensitive electronic equipment and instrumentation devices. For more specific requirements for the protection of sensitive electronic instrumentation, see Instrumentation section.
- c. Lighting and General Power Transformers: Dry type to limit maintenance items. A minimum of (2) taps will be provided above rated voltage (in 2.5% increments) and a minimum of (2) taps will be provided below rated voltage (in 2.5% increments). Open type transformer cases are not allowed. All units located in wet or chemical areas will be of sealed type construction. Provide open ventilated type enclosures for other general dry, environmentally ventilated/conditioned spaces. All transformers to utilize copper windings; 115 degree C rated. The Engineer shall examine the need to install transformers with a higher than average Basic Impulse Level (BIL) that is not normally required in the 480V class.

## 10. Power Monitoring/Metering and Protective Relaying

- a. General: AW objective is to provide power monitoring to allow trouble-shooting, harmonics assessment, and data collection for evaluating efficiency, etc.
- b. AW has a national contract agreement with SEL and is our preferred manufacturer for new work. Refer to RFP for systems involving modifications / upgrades to existing installations
- c. Low Voltage Systems: For small stations involving a limited number of motors / loads, metering as outlined below alone is sufficient. On larger low voltage systems, addition protective relays and monitoring may be appropriate to allow evaluation of sub-distribution equipment and systems and data collection of power characteristics to be captured by the SCADA system for evaluation and reporting. Specific criteria associated with metering and equipment monitoring/protection is to be reviewed with the Owner at the initial design memorandum stage of the project.
- d. Make provisions for power monitoring/metering on incoming three-phase electrical services (main) as follows:
  - All 480/277 VAC services are to provide 3-PTs and CTs wired to field terminal blocks for connection to metering equipment.
  - On installations where the metering is provided by Owner, allow physical space next to main incoming OCP device for meter enclosure installation.
  - On installations where metering is to be provided with equipment, refer to the RFP for specific criteria or review with Owner to define requirements.
- e. Medium Voltage Systems: Power distribution systems involving medium voltage motors and equipment are to be provided with the protective relaying/monitoring devices for not only equipment protection, but also to allow data collection of power characteristics to be captured by the SCADA system for evaluation and reporting. Provide 3- PT / CT input devices and control voltage for power metering and protective relays as required for system protective schemes required by the design.



- f. Data Collection: The use of fiber-optic interface between devices and to SCADA is a preferred method of communicating the data transfer between devices and into the process control system. Applications involving the use of copper are to be specifically approved by the Owner. Where available, dual-port communications capabilities of the protective relays shall be utilized and the devices configured in a loop with IP addressing. The design and configuration of the communications loop and serial connectivity is to be developed as part of the instrumentation design effort.
- g. Power Monitoring/Metering;
  - 1) Provide microprocessor based SEL 735 metering unit on main incoming feeder circuit breaker. Unit shall compute voltage, amperes, power factor, kilowatt-hour, etc. Communications will be via fiber-optic cable back to a port on a plant's process control system.
- h. Protective Relaying;
  - 1) Provide SEL 710 motor protective units on all medium voltage motors wired to plant's process control system for monitoring, trending and archiving.
  - 2) Provide SEL 849 motor protective units on 480 VAC motor loads typically larger than 50 horsepower (*exact application to be coordinated with Project requirements and Owner*) wired to plant's process control system RTU for monitoring, trending and archiving
  - 3) Provide SEL 751A Feeder protective units on MV Feeders wired to plant's process control system for monitoring, trending and archiving
  - 4) Other protective relays as outlined in Attachment C and provided as applicable to the Project
- i. Other SEL protective relays to be provided as determined through the design; reviewed and accepted by the Owner.
- j. SCADA / RTU communications and data acquisition information to be monitored is outlined in Attachment C - SEL Device Monitoring Points (Modbus to SCADA /RTU. This baseline data is to be evaluated and supplemented as appropriate for the project as well as other potentially beneficial data for trend analysis, wire-to-water calculations, and preventative maintenance.
- k. Refer to RFP for additional and/or supplemental information regarding protective relays, applications and coordination of Ethernet communications requirements.

## ATTACHMENTS

- A. American Water Power System Study Requirements – Short Circuit, Protective Coordination, and Arc Flash Hazard Analysis/Evaluation
- B. Acceptable Electrical Equipment Manufacturers and Suppliers
- C. SEL Device Monitoring Points (Modbus to SCADA /RTU)





AMERICAN WATER

**AMERICAN WATER  
POWER SYSTEM STUDY AND  
ARC FLASH ANALYSIS REQUIREMENTS**

**Prepared by:  
American Water Corporate Engineering  
3906 Church Road  
Mt Laurel, NJ 08054**

**Version Date: December 2016  
Latest Engineering Review – March 2018**

## AMERICAN WATER POWER SYSTEM STUDY AND ARC FLASH ANALYSIS REQUIREMENTS

### 1. DESCRIPTION OF WORK REQUIRED

- A. Provide all items of labor, materials and equipment necessary for data collection, development, evaluation and report generation of the work described in this Section. The entire power distribution system (all equipment), new and existing is to be included in the study being provided for this Project.
- B. Visit the site to determine actual conditions, equipment and settings and related elements necessary to prepare a complete oneline diagram of the entire power distribution system. Provide a complete oneline diagram including all equipment (loads/ratings), cable and raceway information and other data associated with the installations to allow evaluation and calculation of the various Studies to be provided in the Report outlined herein. Where required, coordinate field work with the Owner and shall follow all applicable safety standards for the activities required.
  - 1. Those involved with the field data collection work shall review / compare the Owner's operational and safety standards with their own and provide adequate Personal Protective Equipment (PPE) for those individuals involved in any data gathering activities as outlined by applicable Regulatory Agencies. No extra compensation will be allowed by failure to determine existing conditions.
- C. Furnish a complete Short-Circuit, Protective Coordination, and Arc Flash Hazard Analysis Study per the requirements set forth in the criteria established for the Project, the criteria outlined herein this document, and as identified in the latest version of NFPA 70E– 2015 Edition; *Standard for Electrical Safety in the Workplace and as outlined herein regarding American Water Site Specific PPE Category Labeling criteria*. The arc flash hazard analysis shall be performed according to the IEEE Standard 1584-1992 including latest revisions and IEEE 1584-2004 and IEEE 1584-2011 addenda; the IEEE *Guide for Performing Arc-Flash Calculations*; modified as hereinafter identified.
- D. Arc-Flash Equipment Labeling shall be provided upon acceptance of the Engineer's final report. Labeling shall be provided for all equipment as identified herein this document.
- E. In addition, where indicated in the Scope of Work identified by the Owner, provide a Load Flow analysis using the power systems software identified herein to model the operational scenarios required for the project and requested by the Owner. These Load Flow analysis reports are to be provided in accordance with the Owner's criteria for loading and report submission.
- F. Any Drawings and Material Data Sheets / Product Information provided by the Owner is considered as generally indicative of Power System but is not to be considered as matching actual site conditions. Modifications/field changes may have occurred which were not recorded; therefore, provide field verification as necessary to validate the Power System as Work under this project in preparation of the Short-Circuit, Protective-Coordination and Arc-Flash Study and Analysis.
- G. The general (not limited) approach to the evaluation and analysis work included in this assignment shall include the following effort;
  - 1. Collect system and "as-installed" data associated with all electrical equipment, feeders, and devices associated with this Study/Report. This effort shall also include obtaining the

- necessary load-history and available fault current (max and min) and Utility Overcurrent Protective Device (OCP) device(s) from the serving Power Utility Company along with the technical data associated with their system and transformer equipment being provided.
2. Determine system modes of operation by conducting interviews with Owner's Operational / Production Staff
  3. Determine bolted short-circuit and arc fault currents
  4. Determine protective device characteristics and duration of arcs
  5. Document system voltages and classes of equipment
  6. Evaluate existing equipment short circuit ratings against computed available fault currents.
  7. Arc Flash Hazard Analysis to select working distances as outlined herein, determine incident energy for all equipment and determine flash-protection boundary zones for all affected equipment. Conduct arc flash analysis based on the utility fault current and at a value approximately 50% of this or as otherwise determined from the fault current range as provided by the serving Utility Company.
    - a. In addition, where Standby power (generator) is also provided as part of the Project, evaluate the arc flash hazard based on this power source. Summarize each evaluation and develop arc flash labeling based on the worst case scenario or as otherwise accepted by the Owner.
      - 1) Where the installation includes the use of a portable generator, provide a cautionary label on both the transfer switching equipment and on the outdoor generator termination enclosure as outlined in Attachment D.
    - b. Furthermore, provide analysis of any arc flash reduction methods being utilized or included for the equipment. While these devices are not considered in actual labeling, they are to be clearly identified and reported for potential use by maintenance staff when required activities include conducting work on energized and exposed electrical equipment. Provide full analysis of these devices including effects on the downstream equipment being served where applicable.
    - c. Finally, where power distribution systems involve the application of "Main – Tie – Main" or similar multi-operational configurations, provide analysis for these schemes in order to determine effects of the operational differences with regard to loading, short-circuit, protective coordination and arc flash hazard. As above, each operational scenario is to be clearly identified in the reports submitted.

## 2. REFERENCES

- A. ANSI – American National Standards Institute, Inc.
  1. ANSI C57.12.00 – Standard General Requirements for Liquid-Immersed Distribution, Power, and Regulating Transformers
  2. ANSI C37.13 – Standard for Low Voltage AC Power Circuit Breakers Used in Enclosures
  3. ANSI C37.010 – Standard Application Guide for AC High Voltage Circuit Breakers Rated on a Symmetrical Current Basis
  4. ANSI C 37.41 – Standard Design Tests for High Voltage Fuses, Distribution Enclosed Single-Pole Air Switches, Fuse Disconnecting Switches and Accessories.
- B. ASTM – American Society for Testing and Materials
- C. IEEE – Institute of Electrical and Electronic Engineers
  1. IEEE 141 – Recommended Practice for Electric Power Distribution and Coordination of Industrial and Commercial Power Systems
  2. IEEE 242 – Recommended Practice for Protection and Coordination of Industrial and Commercial Power Systems
  3. IEEE 399 – Recommended Practice for Industrial and Commercial Power System Analysis

- 4. IEEE 1584, Latest Edition – Guide for Performing Arc-Flash Hazard Calculations; including all Addenda
- D. IPCEA – Insulated Power Cable Engineers Association
- E. NEMA – National Electrical Manufacturers Association
- F. NESC – National Electrical Safety Code
- G. NFPA – National Fire Protection Association
  - 1. NFPA 70 – National Electrical Code, latest edition
  - 2. NFPA 70E – Standard for Electrical Safety in the Workplace, latest edition

### 3. STUDY REQUIREMENTS

- A. The Work associated with this assignment must comply with all Federal and State, municipal or other authority's laws, rules and/or regulations. These services shall be provided by a qualified, licensed Professional Engineer (hereinafter referred to as Engineer and/or Engineer-of-Record) to conduct the actual analysis, evaluation and development of the Report and Arc Flash labeling.
- B. The Power System Study / Analysis is to include all electrical equipment; and specifically include / address the following:
  - 1. In general (not limited to) and starting at the Utility, all electrical equipment including the main service transformer, Utility OCP device and system ratings shall be evaluated and included in this Study.
  - 2. Where included, all medium voltage equipment, motors, transformers (primary and secondary) shall be included as applicable, as well as all 480 VAC low voltage equipment, motors nominally 25 HP (or as otherwise outlined) and larger, all transfer switch equipment, safety disconnect switches rated 100 amps and above, all automatic and manual transfer switches, panelboards, transformers (primary and secondary locations) and other electrical equipment requiring routine inspection or maintenance while energized (including Infrared (IR) Scans).
    - a. 120/208-240 VAC equipment shall be included in the Study in accordance with the latest information and Addenda issued with IEEE / NFPA criteria, and as outlined herein below
    - b. 120/240 VAC Single phase equipment need not be included in the actual analyses where the fault current is determined to be less than 10 kAIC, but these panelboards and related transformers, etc. shall be shown on the facility's on-line diagrams for identification and labeling shall be provided as outlined herein below.
  - 3. Refer to other criteria and reporting requirements are outlined elsewhere in this Document.
- C. 120/208-240 VAC, Three Phase Power Systems – American Water Corporate Engineering has developed the following recommendations for Arc Flash Hazard labeling on 120/208 – 240 VAC, three-phase grounded and ungrounded power systems:
  - 1. Service-Entrance and sub-distribution locations: AW Engineering recommends the application of a “standard” label (see Attachment B herein) at those locations where the Main OCP device is less than 250 amps and the following criteria has been verified. Typically, this equates to a 100, 150 or 200 amp self-contained metered electrical service application as well as those installations served from a transformer 75 KVA and smaller.



- a. Based on criteria evaluated, and the with specific reference to the 2015 NFPA-70E Tables (“Table 130.7(C)(15)(A)(a) Arc Flash Hazard Identification for Alternating Current (ac) and Direct Current (dc) Systems”), AW recommends that the AW standardized Arc Flash Hazard Warning Labels indicating an Arc Flash PPE Category 2 hazard be used where the following criteria has been determined and/or otherwise verified.
  - 1) Voltage is
    - a. 120/208 VAC, 3-phase, 4-wire (grounded WYE); or
    - b. 120/240 VAC, 3 –Phase, 4-wire (“High-leg Delta”); or
    - c. 240 VAC, 3-phase, 3-wire (Ungrounded Delta)
  - 2) AND, Main OCP device is less than 250A (fused switch or circuit breaker)
  - 3) AND, the Transformer size is 75 KVA or less OR available fault current is less than 22,000 AIC (22 kAIC.)
- b. NOTE: Where the ampacity rating for the electrical service is 250 amps or greater or the transformer is larger than 75 KVA (or available fault current is greater than 22 KAIC), engineering analysis of the system is to be provided.

D. 120/240 VAC, Single-Phase Power Systems – American Water Corporate Engineering has developed the following recommendations for Arc Flash Hazard labeling on 120/240 VAC, single-phase grounded power systems:

- 1. Service-Entrance and sub-distribution locations: AW Engineering recommends the application of a “standard” label (see Attachment C herein) at those locations where the Main OCP device is 200 amps or less and the following criteria has been verified. Typically, this equates to a 100, 150 or 200 amp self-contained metered electrical service applications as well as those installations served from a transformer 25 KVA and smaller.
  - a. Based on criteria evaluated, and the with specific reference to the 2015 NFPA-70E Tables (“Table 130.7(C)(15)(A)(a) Arc Flash Hazard Identification for Alternating Current (ac) and Direct Current (dc) Systems”), AW recommends that the AW standardized Arc Flash Hazard Warning Labels indicating an Arc Flash PPE Category 2 hazard be used where the following criteria has been determined and/or otherwise verified.
    - 1) Voltage is 120/240 VAC, 1-phase,3-wire, grounded
    - 2) AND, main OCP device is 200A or less (fused switch or circuit breaker)
    - 3) AND, the Transformer size is 25 KVA or less OR available fault current is less than 10,000 AIC (10 kAIC.)
  - b. NOTE: Where the ampacity rating for the electrical service is greater than 200 Amps or the transformer is greater than 25 KVA (available fault current is greater than 10KAIC), engineering analysis of the system is to be provided.

E. The Report(s) with calculations must be supplied to the Owner before final equipment labels are printed and applied before the work is considered accepted or approved. The Engineer shall provide documentation for all presumptions / assumptions related to machine impedances, cable impedances (both resistance and inductance), transformer impedances and other equipment values used to complete the computations where obtaining actual data is not available.

- F. The Engineer shall consider fault conditions under minimum, maximum, and average power consumption scenarios based on facility operations as well as in the varying Utility fault conditions outlined previously. The Engineer shall also develop fault scenarios with standby power generators where included and used instead of or in conjunction with the electric utility source along with the other scenarios outlined. Arc Flash Hazard analysis and equipment evaluations to be provided as hereinafter indicated.
- G. All oneline diagrams included in the Study / Report shall utilize naming conventions and identifiers matching the Design Documents or actual equipment field labels; generic identifiers are not considered appropriate. Coordinate equipment naming / identifiers with the Owner taking into account any existing terminology used. Individual oneline diagrams are required for each of the following evaluations as well as each scenario associated with the work outlined for various operational modes, arc reduction methods/devices and multiple configuration capabilities within the power distribution system. The following ones identified are listed only to establish the primary categories associated the overall scope of evaluations to be included; include supplemental documentation as necessary to clearly and individually identify the study scenario and/or evaluation being considered.
1. Provide annotated onelines for the Power Distribution System identifying all equipment and naming conventions as stated above.
  2. Provide annotated onelines identifying the available short-circuit current at each piece of equipment; include this in the Report; tabbed as associated with this topic.
  3. Provide annotated onelines identifying the settings associated with the protective device settings at each piece of equipment; include this in the Report; tabbed as associated with this topic. Additional setting details associated with electronic trip devices, relays, etc. are to be clearly identified and included on the partial oneline clips associated with the protective coordination TCC diagrams.
  4. Provide annotated onelines identifying the Incident Energy and Arc Flash Hazard Level at each piece of equipment; include this in the Report; tabbed as associated with each Topic and Evaluation
  5. All onelines shall be legible and readable with a minimum 10 point (Arial or similar) font size; coordinate drawing size (not to exceed 22" x 34") accordingly. Provide sleeved drawing holders where printed size is larger than 11" x 17".
- H. Short Circuit, Protective Coordination and Arc Flash Hazard Analysis Study
1. A short circuit, protective coordination and arc flash hazard analysis study shall be made for the entire distribution system in accordance with ANSI/IEEE C37.10 & C37.13, IEEE Std. 141, 242 and 399 beginning at Utility connections and ending at the largest feeder from each motor control center or panel as applicable for the system and analysis being conducted in coordination with paragraph "B" above.
  2. Actual Utility data including system and equipment impedances, X/R Ratios, OCP device(s) and other applicable ratings are to be obtained by the Engineer; include this data as provided by the Utility Company in the Report provided.
  3. The protective coordination study shall consist of the following:
    - a. All protective devices contained in the scope of work shall be evaluated. The coordination study shall include computer generated log-log plots of phase overcurrent and where applicable, ground overcurrent protection devices on log-log time-current characteristic paper as produced by the engineering software used for these evaluations and analyses. Complete plots of these devices will be accurately plotted through their operating range. Each TCC Plot shall include a oneline sketch showing the device identifications and



ratings. The Engineer shall identify areas of non-coordination where considerations for modification may be determined. Actual modifications are not necessarily considered included in the scope of services under this project. Any suggested modifications affecting equipment and modifications to the system that the Owner may wish to consider will be handled as a change in the Contract. Appropriate maximum fault levels, transformer inrush currents, conductor insulation withstand curves and transformer damage curves / withstand points shall be plotted on each coordination plot sheet to assure adequate component protection and maximum system reliability.

- b. Where included in the power distribution system, each current transformer shall be checked for saturation to insure that they accurately translate all fault currents which may be available on the system.
- c. All protective relay and solid-state device settings; fuse sizes; and low-voltage circuit breaker settings shall be tabulated and included on the respective TCC.
- d. A complete set of coordination curves (complete with device settings indicated on the TCC) are to be prepared starting with the Utility Company's OCP device(s) and the main distribution devices protecting the Owner's service down through and including all on-site services, feeders, sub-feeders, transformers and secondary main and branch circuit devices, shall be included in the Study. These shall be arranged to provide a uniform approach to the review and device coordination for the system and shall include a "snap-shot"/annotated oneline diagram on each TCC sheet outlining the devices included. Provide sufficient overlap on the TCC evaluations included to demonstrate "upstream / downstream" coordination.
- e. The Engineer shall also evaluate ground fault protection where provided in conjunction with the project. Provide Time Current Characteristic (TCC) curves for all GFI circuit breaker equipment protection as outlined above.
- f. Motor starting current profiles for all large motors (over 25 HP or as otherwise determined and accepted by the Owner) shall be included on the appropriate TCC's to identify coordination and provided based on the starter type being provided; other motors to be configured as combined loads as applicable to the application
- g. Tabulations shall include a listing of the worst-case calculated short circuit duties as a percentage of the applied device rating (automatic transfer switches, circuit breakers, fuses, etc.); the short circuit duties shall be upward-adjusted for X/R ratios that are above the device design ratings. This tabulation shall also include indication of acceptability or, in the event of a noted deficiency, provide recommended solution for corrective action.
- h. As indicated, points of non-coordination shall be brought to the attention of the Owner; provide existing TCC identifying the issue and a separate TCC outlining proposed modifications and/or adjustments recommended for corrective action.
- i. The Study shall include all electrical equipment as included in the Scope of Work for this assignment. The use of documentation and record information as may be provided by the Owner shall not be construed as providing all data necessary; the EOR shall be responsible to conduct or obtain field verification necessary to determine / obtain all required data in establishing the power distribution one-line diagram for the system being evaluated.
- j. Submissions and approval of these studies are required as outlined herein after in this document.

4. Arc Flash Hazard Analysis
  - a. The arc flash hazard analysis shall include the incident energy and flash boundary calculations.
    - 1) Unless otherwise specified or approved in writing by the Owner, the EOR shall utilize a Working Distance of 18 inches for ALL voltage levels (low & medium voltage values). Typical other typical distances (i.e... 24" or 36") for low voltage systems and/or 36" for medium voltage systems as otherwise permitted under NFPA-70E / IEEE are not permitted.
    - 2) As indicated, calculated incident energy values shall be provided for both line and load sides of all transformers and the overcurrent protective devices served from these transformers or other separately derived sources and labeling developed to identify both calculated Incident Energy and Site-specific Arc Flash PPE Category values in addition to other equipment and devices as previously outlined herein. Equipment Arc Flash Hazard Analysis labeling to be provided with this and other labeling information as outlined herein to properly identify and notify workers to the hazards present.
  - b. The Engineer shall furnish the Arc Flash Hazard Analysis Study per the latest edition of NFPA 70E - *Standard for Electrical Safety in the Workplace*, reference Article 130.3 and as indicated in Annex D to these specifications.
  - c. The analysis shall utilize the appropriate short-circuit and clearing times associated with the over-current protective devices. Where this information is not available, alternative methods for similar devices shall be identified and submitted in the study for review and comment by the Owner.
    - 1) The arc flash study shall be run under a minimum of the following scenarios in order to account for varying source conditions and available Utility deviations. The worst case from these scenarios shall be considered in developing the PPE and Arc Flash Labeling for the equipment unless otherwise discussed and accepted by the Owner. Power Study scenarios to be considered include;
      - a) Utility at nominal short circuit contribution,
      - b) Utility at 50% of nominal contribution (or as otherwise determined based on available range of Utility data), and
      - c) Standby (generator) contribution (where applicable)
      - d) Other scenarios as previously indicated.
    - 2) Incident energy is greatly influenced by protective device clearing time, which is determined by the available short circuit current at that location. The intent for utilizing a 50% source is to provide some measure of assurance that a "low" utility source will not result in incident energy values higher than those indicated on the equipment labels.
    - 3) The flash protection boundary and the incident energy shall be calculated at all significant locations in the electrical distribution system as outlined herein.
  - d. The Arc-Flash Hazard Analysis shall include all medium voltage and 480/277 volt locations, as well as those three phase locations associated with the 240 volt and 208 volt systems as previously outlined..
  - e. All electrical equipment as herein outlined shall be labeled regardless of the arc-flash energy / incident energy level determined.
  - f. Safe working distances shall be identified for calculated fault locations based upon a calculated arc flash boundary considering a minimum Incident Energy level of 4 cal/cm<sup>2</sup>; site-specific Arc Flash PPE Category as identified in Attachment D. Working distances shall be based on 18" as outlined previously and in accordance with the general criteria as outlined in IEEE

1584. The calculated arc flash protection boundary shall be determined using this working distances.

- g. The Arc Flash Hazard analysis shall include calculations for contributions of fault current magnitude (based on the available fault-current values and not the AIC ratings of the equipment) as previously outlined herein. The calculations shall include all motor and other sources that can contribute to the available fault current. Where necessary, the Arc-Flash Hazard Analysis shall be performed utilizing mutually agreed upon facility operational conditions, and the final report shall describe, when applicable, how these conditions differ from worst-case bolted fault conditions.
- h. As previously noted, Arc flash computations shall include line and load side calculations associated with the "main" (service-entrance) breaker as well as any other transformer OCP devices associated with internal power distribution. Arc Flash calculations shall be based on actual overcurrent protective device clearing time. AW does not consider the use of this IEEE Exception to be appropriate. (Maximum clearing time of 2 seconds *based on IEEE 1584 is not acceptable*)
- i. Results of the Analysis shall be submitted in tabular form, include device or bus name, (based on actual naming ID as identified on the Facility Oneline Diagram; not simply an ID assigned by the software), bolted fault and arcing fault current levels at the various scenarios outlined herein, flash protection boundary distances, personal-protective equipment classes and the arc flash incident energy levels determined. These results shall also be included on the oneline diagram associated with the specific study/scenario being evaluated.
- j. The Report shall also include identification of the Personnel-Protective Equipment (PPE) Categories and identify minimum PPE required for each location. This information shall be included in the Report but not shown on the equipment labels.
- k. Arc Flash Labeling of Electrical Equipment: Provide copies of the Arc Flash Labels (see sample attached below) in the Report for documentation of the information being identified on the equipment in a separately tabbed section of the report. Include in this section definitions of the terms and distances outlined along with information on the various PPE equipment classifications indicated.

#### **4. POWER SYSTEM STUDY AND ARC FLASH ANALYSIS QUALIFICATIONS**

- A. The short-circuit, protective device coordination and arc flash hazard analysis studies shall be conducted under the supervision and approval of a Registered Professional Electrical Engineer skilled (*minimum of 10 years of demonstrated experience in conducting power systems studies; provide qualifications upon request*) in performing and interpreting the power system studies. The final report, including copies of the Arc Flash Labels, shall be sealed and signed by the EOR.

#### **5. ENGINEERING STUDY / REPORT SUBMISSIONS**

- A. Submit the following Reports for AW Engineering / Owner Review and Comment. Coordinate these submission with the Design Criteria / Documentation Submissions as outlined for the Project. In general, the "Preliminary" Report should be provided with the 30% Design (or otherwise defined Project) Submission; the "Pre-Final" Report with the 60% submission and the "Final" Report provided with the 100% submission. Final

adjusted report information, including final equipment labels to be provided once all field adjustments and acceptance testing has been completed. This Record Document Report shall be provided as part of the Operation and Maintenance Documents.

1. Preliminary – Submission to contain an annotated One-line Power Riser Distribution Diagram with OCP devices and other basic configurations associated with the power distribution system included; not a completely detailed and documented diagram. This diagram is intended to show the available power sources and devices which comprise the system and its configuration for operation. Additionally, this initial diagram is to include the major loads and presumptions for miscellaneous general power requirements which may be appropriate in considering Load Flow evaluations where necessary.
  - a. As part of this Preliminary effort, consideration related to new equipment selections shall be included. Provide initial discussion and/or indication related to proposed equipment for Owner consideration and comment.
  - b. Include the overall oneline diagram utilizing this simplified computer modeling approach. This information and modeling will allow basic configuration, operations and evaluations associated with equipment short-circuit ratings and types of devices to be considered / developed with the Owner.
  
2. Pre-Final – Report to contain an annotated One-line Power Riser Distribution Diagram with OCP devices, device ratings/settings and cable feeders (conductor size/type and raceway size/type) identified.
  - a. As part of this continuing effort, consideration related to equipment selections shall include type of device and over-current protective features needed for protective coordination with other elements of the power distribution system and loads served. (including type of trip unit, potential arc flash reduction methods as applicable, etc.).
  - b. Calculations associated with Short-Circuit AIC values and Equipment suitability along with Arc-Flash Hazard Analysis Report and sample of proposed / typical ANSI Z535.\* label information (*\*current edition*) documentation are to be included.
  - c. Included in this Report, Oneline Drawings for the overall Power Distribution Power Riser diagram, an annotated oneline outlining the Short-Circuit ampacity values calculated, and an annotated oneline showing the Arc Flash Incident Energy and PPE Levels calculated.
  - d. In addition, a copy of the oneline diagram with the OCP devices indicated shall be included with the Protective Coordination TCC's. Each TCC shall include the partial oneline drawing associated with the protective coordination elements being evaluated and included.
  
3. Final - Provide a written response to Owner comments provided regarding Pre-Final Study Report. Finalize the information; update data, settings and other appropriate information including any accepted recommendations and/or modifications.
  - a. Provide three hard-copies of each submission Report as well as editable Word electronic formatted Report document with the Final submission. Power Distribution Riser Diagrams shall be provided for all analysis configurations conducted including, but not limited to, short-circuit models for minimum and maximum operational scenarios and arc flash hazard models. Include hardcopies of equipment reports and calculations performed.
  - b. Submit an electronic copy of the final Arc Flash Hazard Analysis and One-line Power Riser Diagram, complete with all associated equipment



databases formatted with the engineering software used and as outlined herein.

- c. It is recommended that the final report include the following sections:
  - 1) Executive Summary including Introduction, Scope of Work and Results/Recommendations
  - 2) Short-Circuit Methodology Analysis Results and Recommendations
  - 3) Short-Circuit Device Evaluation Table
  - 4) Protective Device Coordination Methodology Analysis Results and Recommendations
  - 5) Annotated and revised oneline diagrams (all) as outlined in "2" above shall be provided with the Final Report.
  - 6) Protective Device Settings Table associated with the field installed devices.
  - 7) Time-Current Coordination Graphs and Recommendations
  - 8) Arc Flash Hazard Methodology Analysis Results and Recommendations including the details of the incident energy and flash protection boundary calculations, along with Arc Flash boundary distances, working distances, Incident Energy levels and Personal Protection Equipment levels.
  - 9) Arc Flash Labeling section showing types of labels to be provided. Section will contain descriptive information as well as actual copies of the label images.
  - 10) One-line system diagram that shall be computer generated and will clearly identify individual equipment buses, bus numbers used in the short-circuit analysis, cable and bus connections between the equipment, calculated maximum short-circuit current at each bus location, device numbers used in the time-current coordination analysis, and other information pertinent to the computer analysis.

B. Upon acceptance of the Final Report, provide labeling of the power distribution equipment in accordance with ANSI Z535.4– Product Safety Signs and Labels; label size to be 4" x 6". Labels to be provided as outlined in Articles 1.03, C and 3.03 below. Label materials furnished to be suitable for either the interior or exterior locations where they are to be applied; provide samples for review and approval by the Owner along with data sheets from the Manufacturer outlining these applications.

C. As part of the final documentation associated with the project Record Drawing data, provide a copy of the oneline diagram that includes the essential equipment and devices without ratings to provide a concise representation of the power distribution system. All equipment and devices shall be identified based on the actual nameplates and identifiers developed under the project design; coordinate with final nameplates provided. Drawing size to be based on size of power distribution system but shall be large enough to provide clear reading of the text based on an Arial 10 point font or equivalent of the equipment naming and identifiers; maximum sheet size to be 22" x 34". Provide multiple drawings for systems where information cannot be legibly contained on a single sheet. This diagram is to include all revisions and modifications determined through the course of construction.

## **6. COMPUTER ANALYSIS SOFTWARE**

A. The studies shall be performed using ETAP power systems software as provided by Operation Technology, Inc. (OTI), or SKM Systems Analysis Power Tools for Windows (PTW) software program.

- B. Provide a final electronic file copy of all data, reports and the oneline diagram in electronic engineering database (ETAP or SKM) format to the Owner prior to final acceptance of the Project. This information is to be validated by the EOR as representing "As-Built" conditions including all over-current protective devices and their settings, feeder conductors and raceway information and load data; including inductive, resistive and combination loads.
- C. The files shall contain all Reports (in Microsoft Word) conducted including Short-Circuit evaluations, Protective Coordination and Load Flow Studies as well as the Arc Flash analysis values determined as well as copies of the Arc Flash labels. The EOR for the Study shall attest to this validation in writing when submitting the final electronic copy of the project.

## **7. FIELD INVESTIGATION / DATA COLLECTION AND IMPLEMENTATION ACTIVITIES**

- A. The Engineer (or authorized designee of the Engineer) conducting the field data collection work shall review and provide compliance with the following:
  - 1. Continuity of Service:
    - a. If any service or system must be interrupted, the Engineer shall request permission in writing stating the date, time, etc. the same will be interrupted and the areas affected. This request shall be made in sufficient time (approximately 1 week minimum in advance) for proper arrangements to be made. Written permission shall be obtained from the Owner before any interruption to electrical power is permitted.
  - 2. Lock-Out / Tag-Out Procedures
    - a. The Engineer shall provide his own lock-out / tag-out equipment in coordination with the Owner's program; coordinate with the Owner's field operational and maintenance staff.
    - b. The Engineer shall have in effect a written safety program that includes a lock-out / tag-out safety program in accordance with OSHA under Part 1910, Subpart S.
  - 3. Electrical Safety Program
    - a. The Engineer shall review the Owner's Electrical Safety Program and take the necessary precautions, in conjunction with his own safety program for employee protection.
    - b. The Engineer is to have in effect a written electrical safety program that includes all applicable provisions of the NFPA-70E which has been adopted by OSHA under Part 1910, Subpart S.
- B. The Engineer shall provide written documentation indicating that his employees, those working on American Water projects, have been trained and certified on all provisions applicable to B and C above upon request from the Water Company.
- C. The Engineer's employees shall follow all provisions of "B" and "C" above including, but not limited to, the use of personal protective equipment (PPE), establish protective barriers, approach boundaries and documentation for such activities. Provide a written statement attesting to the above requirements prior to the start of the Field Investigation / Data Collection activities.
- D. Field Adjustment
  - 1. The Engineer shall adjust protective devices settings based on the final accepted Study/Report provided by the Engineer; settings to be listed in a table format and submitted as part of the final O&M Manual for the equipment / system.

E. Arc Flash Warning Labels

1. Provide an ANSI Z535.4 compliant (size 4 in. x 6 in.) thermal transfer or equivalent type two color die-cut arc flash label as provided by DuraLabel or Brady for each work location analyzed and included in this project. Material type to be suitable for the locations; IE indoor, outdoor, chemical resistively, etc.
2. The label shall have either an orange header with black lettering and the wording, "**WARNING, ARC FLASH HAZARD**", or a red header with white lettering and the wording, "**DANGER, ARC FLASH HAZARD**". Include the ANSI Safety Symbol in the header as recommended. The Danger signal wording shall be provided for all calculated incident energy values greater than 40 Cal/cm<sup>2</sup>; Warning to be used for all calculated incident energy values below 40 Cal/cm<sup>2</sup>. These labels shall include the following information:
  - a. Location designation
  - b. Shock Hazard Information including; Nominal voltage, Limited Approach and Restricted Approach with Covers Removed
  - c. Flash protection boundary
  - d. Site-specific Arc Flash PPE Category
  - e. Available Fault Current – include reference to Power Study as outlined on sample labels included in the Attachments to this criteria
  - f. Incident energy (calculated based on Incident Energy Analysis Method)
  - g. Working distance (18" typical for all equipment and applications)
  - h. Engineer, report number, revision number and issue date
  - i. Reference to "Owner's Arc Flash Procedures Manual" in lieu of actual listing of clothing and glove requirements.

*Refer to Attachment at end of this document for Sample Label and Information to be included*

3. Labels shall be machine printed, with no field markings. The size of the lettering is to be in accordance with ANSI-Z535.4 recommendations for a safe viewing distance of 3' minimum based on favorable viewing conditions and information to be included.
4. Arc flash labels shall be provided in the following manner and all labels shall be based on recommended over-current device settings. Coordinate the data provided with the Arc Flash Study results and the ANSI labeling requirements. Quantities outlined below are considered minimum quantities necessary; provide additional labeling as may be required by Regulatory or Inspection Agencies at no additional cost to the project.
  - a. For each transformer, 480 and applicable 240 and/or 208 volt panelboard, individually-mounted circuit breaker and safety disconnect device, one arc flash label shall be provided
  - b. For each motor control center, one arc flash label shall be provided at the top of each vertical section (*see footnote below*).
  - c. For each low voltage switchboard, one arc flash label shall be provided at the top of each vertical section (*see footnote below*).
  - d. For each low voltage switchgear, one arc flash label shall be provided at the top of each vertical section (*see footnote below*).
  - e. For each medium voltage switchgear, one arc flash label shall be provided for each cell within each vertical section (*see footnote below*).
  - f. For medium voltage switches one arc flash label shall be provided at the top of each vertical section (*see footnote below*).

- g. For each motor power terminal box, 25 horsepower and larger, one arc flash label shall be provided.
- h. Additional arc flash labels to address installations and specific equipment requirements to be provided based on an individual evaluation basis and coordinated with the Owner.
- i. General Use Safety labels shall be installed on equipment in coordination with the Arc Flash labels. The General Use Safety labels shall warn of general electrical hazards associated with shock, arc flash, and explosions, and instruct workers to turn off power prior to work.

*(Footnote – where control center, switchboard, or switchgear assemblies are dual-fed, provide an arc flash label at each main entrance device or section as well as at any “Tie” device location. For equipment that is front and rear accessible, provide the same labeling on the rear sections as outlined above.)*

- 5. Labels shall be field installed by the (Contractor or Engineer) at the conclusion of the project after acceptance by the Owner.

## 8. ATTACHMENTS

A. Sample Labels - Three Phase Systems involving calculated incident energy analysis:

- 1. DANGER
- 2. WARNING

B. Sample Labels – Three Phase 120/208-240 VAC Systems associated with AW Standardized labeling

- 1. WARNING

C. Sample Labels – Single Phase 120/240 VAC Systems associated with AW Standardized labeling

- 1. WARNING

D. AW Engineering Criteria for Portable Generator Transfer Switch and Termination Enclosure Identification

E. AW Engineering Criteria for Site Specific Arc Flash PPE Category Identification



**ATTACHMENT A –  
Three Phase Systems involving calculated incident energy analysis**

**! DANGER**

**Energized Work Prohibited  
No Safe PPE Exists**

Arc Flash Boundary: 10.6 Feet	Arc Flash PPE Category
Incident Energy: <u>60.06 cal/cm<sup>2</sup></u>	<b>FCT Not Determined</b>
Working Distance: 18 inches	PPE: See AW AF Manual for Minimum Arc Rating of Clothing
Shock Hazard when covers removed	
Shock Hazard Exposure: <u>480 VAC</u>	Refer to Power Study for Equipment's Available Fault Current
Limited Approach Boundary: 3.5 feet	
Restricted Approach Boundary: 1 feet	

Equipment: MAIN-CB  
File: PAAW ROUTE 19 BPS w GEN

Engineer: AWBSE, MIL, GO  
Date: 09-08-2014

**! WARNING**

**Arc Flash and Shock Hazard Present  
Appropriate PPE Required**

Arc Flash Boundary: 0.8 Feet	Arc Flash PPE Category
Incident Energy: <u>0.330006 cal/cm<sup>2</sup></u>	<b>1</b>
Working Distance: 18 inches	PPE: See AW AF Manual for Minimum Arc Rating of Clothing
Shock Hazard when covers removed	
Shock Hazard Exposure: <u>480 VAC</u>	Refer to Power Study for Equipment's Available Fault Current
Limited Approach Boundary: 3.5 feet	
Restricted Approach Boundary: 1 feet	

Equipment: LV-XFRMR-LINE  
File: PAAW ROUTE 19 BPS w GEN

Engineer: AWBSE, MIL, GO  
Date: 09-08-2014

**ATTACHMENT B -  
Three Phase 120/208-240 VAC Systems associated with AW Standardized labeling**

**! WARNING**

**Arc Flash and Shock Hazard Present  
Appropriate PPE Required**

<b>Arc Flash Boundary:</b> 3 Feet	<b>Arc Flash PPE Category</b>
<b>Working Distance:</b> 18 inches	<b>2</b>
<b>Shock Hazard:</b> When covers removed	<b>PPE:</b> See AW AF Manual for Minimum Arc Rating of Clothing
<b>Shock Hazard Exposure:</b> 208Y/120VAC, Three Phase	<b>Fault Current:</b> Less than 14kA
<b>Limited Approach Boundary:</b> 42 inches	
<b>Restricted Approach Boundary:</b> Avoid Contact	

File: AWBSE\_120-208\_3\_Ph Evaluation      Date: 2015-10-22

**! WARNING**

**Arc Flash and Shock Hazard Present  
Appropriate PPE Required**

<b>Arc Flash Boundary:</b> 3 Feet	<b>Arc Flash PPE Category</b>
<b>Working Distance:</b> 18 inches	<b>2</b>
<b>Shock Hazard:</b> When covers removed	<b>PPE:</b> See AW AF Manual for Minimum Arc Rating of Clothing
<b>Shock Hazard Exposure:</b> 120/240VAC, Three Phase	<b>Fault Current:</b> Less than 14kA
<b>Limited Approach Boundary:</b> 42 inches	
<b>Restricted Approach Boundary:</b> Avoid Contact	

File: AWBSE\_120-240\_3\_Ph Evaluation      Date: 2015-10-22

**ATTACHMENT C –**

**Single Phase 120/240 VAC Systems associated with AW Standardized labeling**

	
<b>Arc Flash and Shock Hazard Present Appropriate PPE Required</b>	
Arc Flash Boundary: 3 Feet	<b>Arc Flash PPE Category</b>
Working Distance: 18 inches	<b>2</b>
Shock Hazard: when covers removed	PPE: See AW AF Manual for Minimum Arc Rating of Clothing
Shock Hazard Exposure: 120/240 Single Phase VAC	Fault Current: less than 10 kA
Limited Approach Boundary: 42 inches	
Restricted Approach Boundary: Avoid Contact	Date: 2014-10-28
File: AWBSE_120/240_1_Ph Evaluation	

ATTACHMENT D –

AW Engineering Criteria for Portable Generator Transfer Switch and Termination Enclosure Identification



**CAUTION**

**PORTABLE GENERATOR APPLICATION**

**Arc Flash and Shock Hazard have not been evaluated for this equipment; Dangerous conditions may exist when covers are removed.**

The line side terminations from the generator can be potentially greater than 40 cal/cm<sup>2</sup>.

Equipment: **PORTABLE GENERATOR INSTALLATION**  
File: AFHA Portable Generator Label

Engineer: AW ENGINEERING  
Date: 11-2015

ATTACHMENT E –

American Water Engineering Criteria for Site Specific Arc Flash PPE Category Identification

Incident Energy Range (cal/cm <sup>2</sup> )	Arc Flash PPE Category
0 – 4.0	1
4.01 – 8.0	2
8.01 – 25.0	3
25.01 – 40.0	4
40.01 and above	DANGEROUS (No Safe PPE Exists)

## AMERICAN WATER ACCEPTABLE ELECTRICAL EQUIPMENT MANUFACTURERS AND SUPPLIERS

The following listing is intended to identify those manufacturers that are generally acceptable and capable of meeting American Water's Recommended Design Standards, and provides a unified approach in design, maintenance and operation across the entire Company.

Unless specifically indicated, the naming of the manufacturers outlined below is not intended to provide the specified "order" for equipment selections. The list should be reviewed with the Water Company during the initial design phase to add or eliminate any manufacturers that are preferred or rejected by the local Operations team. The Consultant may propose other suppliers/manufacturers for Owner review and acceptance based on the specific nature of the Work and site location and/or conditions. The Consultant shall include a listing of proposed major electrical equipment manufacturers with the Design Memorandum for consideration by the Owner. The Basis of Design shall be established based on the Owner's preferences.

Note: These manufacturers and descriptions below are intended to outline the basis for the equipment design and criteria for development in the project; not exclusive approval.

Equipment Description	Manufacturers
MV Switchgear – Vacuum Breaker, Draw-Out	Cutler-Hammer Square D ABB Siemens General Electric
Medium Voltage Automatic Transfer Switchgear (Circuit Breaker Transfer Equipment – Manual or Automatic)	Cutler-Hammer Square D ABB Siemens General Electric Or Acceptable Manufacturer from above provided by Generator Equipment Manufacturer (subject to Owner approval)
MV Fusible Switchgear	Cutler-Hammer Square D ( <i>Note - HVLcc Type Equip Not Accepted</i> ) ABB Siemens General Electric S&C
MV Switchgear – SF6 Type	<i>Not Preferred Equipment</i>
MV Motor Control Equipment, MC Lineups (FVNR, RVSS Equipment)	Cutler-Hammer ABB Siemens General Electric
MV Variable Frequency Drives	Toshiba Allen Bradley – Voltage Source Equipment (not Current Source Drive) Cutler-Hammer Siemens/Robicon

Equipment Description	Manufacturers
LV Power Distribution Equipment – (Swgr, Swbds, Panelboards, Circuit Breakers, etc)	Cutler-Hammer Square D ABB Siemens General Electric
Transformers – Dry Type, VPI, VPE Insulation	Cutler-Hammer Square D/Sorgel Siemens ABB
Transformers – Cast-Coil	Square D/Sorgel ABB
Transformers – Liquid-Filled	<i>Not Preferred Equipment</i>
Protection Relays & Monitoring Relays for Voltage, Current, Phase Loss, Etc.	SEL (Schweitzer Engineering Laboratories) <i>Other acceptable manufacturers may include the following (subject to prior approval by AW Engr / Owner) All to be provided with Fiber-Optic Communications over Ethernet / Modbus TCP/IP</i>
Power Quality Metering, Motor Monitoring & Feeder Protection Relays	SEL 735, SEL 710, SEL 751A, SEL-489 Other SEL devices as applicable for the design of the power distribution system. <i>Communications to utilize fiber-optic interface; dual-port for loop configuration where available. Copper communications to be utilized only where specifically indicated. All to be provided with Fiber-Optic Communications capability Ethernet / Modbus TCP/IP and DNP3</i>
Low Voltage Motor Control Centers	Cutler-Hammer Square D ABB Siemens General Electric
Full Voltage Motor Starters	Cutler-Hammer Square D ABB Siemens General Electric
Reduced Voltage (Solid-State, Soft Start) Motor Starters	Cutler-Hammer Square D ABB Siemens General Electric Danfoss Benshaw



Equipment Description	Manufacturers
<p>Low Voltage Variable Frequency Drives – Stand Alone Applications (Free-Standing or Wall Mounted Units)</p> <p><i>NOTE: Basic Criteria - All VFD equipment to be "Heavy Duty" / "Industrial Duty", rated for 50 C. and suitable for full load rating with 3% voltage unbalance. Cooling fans shall be accessible without requiring total dismantling of the drive assembly; top outlet discharge preferred.</i></p> <p><i>"HVAC Rated" Drives are Not Permitted</i></p> <p><i>** NEMA4X Note: Drive assembly to be rated NEMA 4x by manufacturer; use of open chassis or NEMA 1 drives installed in NEMA 4x enclosure is not suitable in meeting this criteria.</i></p>	<p><u>Free-Standing – Wall or Floor Mounted</u></p> <p>Square D Cutler-Hammer Allen Bradley Toshiba ABB Siemens/Robicon Danfoss Benshaw Yaskawa</p> <p><u>NEMA 4X Type (where required)**</u></p> <p>Allen Bradley Yaskawa T B Woods Others as determined suitable for the application</p> <p>Harmonic Filters (where required) TCI Mirrus MTE</p>
<p>Low Voltage Variable Frequency Drives – Part of MCC Lineup/Equipment <i>(Not an AW preferred method)</i></p>	<p>Cutler-Hammer Square D ABB Seimens General Electric</p>
<p>Low Voltage Automatic or Manual Transfer "Switches" – Contactor Type assembly</p>	<p>ASCO 4000 Series (unless otherwise suitable) Other potential Suppliers include: Cutler-Hammer GE/Zenith Russelectric</p>
<p>Low Voltage (<i>Service Entrance Rated where applicable</i>) Automatic Transfer Equipment (Circuit Breaker Transfer Equipment – Manual or Automatic) <i>NOTE: Circuit Breaker – Main and Circuit Breaker – Standby (where identified) REQUIRED unless specifically accepted otherwise</i></p>	<p>Cutler-Hammer/Eaton Square D ASCO 4000 Series Russelectic Switchgear General Electric</p>
<p>Uninterrupted Power Supplies</p>	<p>APC Powerware General Electric Mesta Liebert MCG</p>

Equipment Description	Manufacturers
<p>Surge Protective Devices (UL-1449, Rev 4 Compliant and <b>Listed/Labeled</b>)  <i>Note: use of integral SPD with panelboards and equipment not permitted; provide stand-alone external devices only unless otherwise specifically approved</i></p>	<p>APT – Advanced Protection Technologies “XDS” Series  MCG  Cutler-Hammer “SPD” Series</p>
<p>NOTE: The following descriptions provide general guidelines for lighting fixtures and applications.</p> <p>As LED technology continues to be available at lower costs, American Water recommends evaluation between LED and Fluorescent lamps/fixtures.  Where fluorescent fixtures are used (T-5 and T-8 fluorescent lamps), provide Programmed / Rapid-Start Ballasts. <i>(note- the use of Instant-Start ballasts is prohibited)</i></p> <p>The use of LED technology is recommended for all exterior applications unless special aesthetic and/or other site-specific criteria is established by the Owner or Regulatory Authority</p>	
<p>Lighting Fixtures – Fluorescent T-8 lamps, Program-Start Ballasts, Indoor Enclosed and Gasketed Fluorescent for Damp and Wet Locations (Process and Chemical Rooms)</p>	<p>EPCO GFF Series w/SS Latches, Simkar EN 2 or 3 w/SS Latches, Holophane ERS Series, Lithonia FSW or FHE Series, ILS  Others as accepted by Owner  <i>(Note – the use of fixtures similar to Lithonia DMR Series, Columbia LUN Series, Simkar OV450, etc are generally prohibited due to on-going physical / performance issues associated with this type of design (limited latches retaining sealed integrity of the assembly) ). Fixture selection is to take into consideration lamp output, lumen maintenance, and environmental factors associated maintainability of the overall system.</i></p>
<p>Lighting Fixtures – Fluorescent T-8 lamps, Program-Start Ballasts, Indoor dry applications</p>	<p>Benjamin, Philips,  Keene, Lithonia and  Others as accepted by Owner</p>
<p>Lighting Fixtures – Fluorescent T-8 lamps, Program-Start Ballasts, Indoor Hazardous Locations</p>	<p>Appleton  Crouse-Hinds  Killark  Others as accepted by Owner</p>
<p>Lighting Fixtures – LED Indoor</p>	<p>Lithonia  Philips  Cree  Others as accepted by Owner</p>
<p>All LED luminaires must be UL Listed (e.g. UL8753 / UL8750) and tested to IESNA LM-79 and LM-80 standards and that the results of those tests must be submitted to the Owner as part of the submittal review process. LED fixtures to be provided with a minimum 5 year warranty covering the driver, the LED components and the luminaire.</p>	
<p>Lighting Fixtures – LED Outdoor</p>	<p>RAB  Cree  Philips  Dialight  Lithonia  Others as accepted by Owner</p>
<p>Lighting Fixtures – HPS Outdoor</p>	<p>Holophane, Infranor  Devine, Philips  Others as accepted by Owner</p>



Equipment Description	Manufacturers
Lighting Control - Occupancy Sensors	Sensor Switch (High Humidity / Low Temperature Type) – process & chem. Areas Leviton, Hubbell, P&S along with others mfgs and products to be provided as determined suitable for the location and environment where installed. <i>NOTE: Technology (passive IR, ultrasonic, or dual) to be based on location where installed.</i>
Lighting Control – Daylight Harvesting and/or Special Function and Dimming	Lutron Wattstopper Day Light Controls Others as accepted by Owner
Control and Timing Relays (“Ice-cube” relay style)	Diversified Potter Brumfield Syrelec Allen Bradley Square D Cutler-Hammer Seimens Releco Others as accepted by Owner
Push Buttons, Selector Switches & Pilot Lights (30 mm minimum size devices, NEMA 4X style preferred and high-intensity LED pilot lamps)	Cutler-Hammer Square D Seimens Allen Bradley Kraus & Naimer
Definite Purpose Relays and Contactors	Cutler Hammer Square D Siemens Allen Bradley
PVC Coated Rigid Steel Conduit	Ocal Robroy
Fiberglass Conduit	Champion FRE
Power Generation Equipment – (Diesel engine driven units)	Onan/Cummins Caterpillar Kohler Others only as determined accepted by Owner
Industrial and Corrosion Resistant Wiring Devices	Cooper Industries Legrand Leviton Hubbell Meltric Woodhead, <a href="http://www.woodheadsales.com">http://www.woodheadsales.com</a>



## Attachment 3.4

### SEL Device Monitoring Points (Modbus to SCADA /RTU)

The following Information represents typical data monitoring from many of the SEL metering and protective relays identified in the AW Recommended Electrical Design Criteria and Standards.

The information provided herein as a starting point for baseline data acquisition; additional information may also be required for specific maintenance assistance, trend analysis, etc. and does not include all of the data points/registers available.

The Engineer is to review with the Owner potential supplemental data and configuration that may be needed or recommended based on the specifics of the project, preventative maintenance, alarm reporting as well as other devices.

#### SEL-735:

TCP Modbus Register	Signal
912	PFT3_True_Power_Factor_3_Phase
351	IA_Phase_A_RMS_Current
353	IB_Phase_B_RMS_Current
355	IC_Phase_C_RMS_Current
1016	VAB_RMS_Voltage
368	VBC_RMS_Voltage
370	VCA_RMS_Voltage
901	Frequency
1020	W3_3_Phase_kWatts

## Attachment C- 3.4

### SEL Device Monitoring Points (Modbus to SCADA /RTU)

#### SEL-710

<b>TCP Modbus Register</b>	<b>Signal</b>
689	ApparentPwr
714	BearingTempMax
651	CurrentA
653	CurrentB
655	CurrentC
664	CurrentImbal
1806	Enabled
1827	Fault
690	Frequency
691	MWhOut_HighWord
692	MWhOut_LowWord
692	MWhOut_Total
689	PowerFactor
687	ReactivePwr
686	RealPwr
1694	TotDemand
1699	TotPeakDemand
1806	TripAlarm
668	VoltageAB
670	VoltageBC
672	VoltageCA
685	VoltageImbal
713	WindingTempMax

## SEL Device Monitoring Points (Modbus to SCADA /RTU)

SEL-751A

TCP Modbus Register	Signal
689	ApparentPwr
651	CurrentA
653	CurrentB
655	CurrentC
664	CurrentImbal
1806	Enabled
1827	Fault
690	Frequency
691	MWhOut_HighWord
692	MWhOut_LowWord
689	PowerFactor
687	ReactivePwr
686	RealPwr
1694	TotDemand
1699	TotPeakDemand
1806	TripAlarm
668	VoltageAB
670	VoltageBC
672	VoltageCA
685	VoltageImbal
692	MWhOut_Total
144	BreakerClosed

**SEL Device Monitoring Points (Modbus to SCADA /RTU)****SEL-351**

<b>TCP Modbus Register</b>	<b>Signal</b>
689	ApparentPwr
193	BreakerClosed
651	CurrentA
653	CurrentB
655	CurrentC
664	CurrentImbal
1806	Enabled
1827	Fault
690	Frequency
691	MWhOut_HighWord
692	MWhOut_LowWord
692	MWhOut_Total
689	PowerFactor
687	ReactivePwr
686	RealPwr
1694	TotDemand
1699	TotPeakDemand
1806	TripAlarm
668	VoltageAB
670	VoltageBC
672	VoltageCA

## SEL Device Monitoring Points (Modbus to SCADA /RTU)

SEL-787

TCP Modbus Register	Signal
729	ApparentPwr
176	BreakerClosed
685	CurrentA
687	CurrentB
689	CurrentC
8	Enabled
732	Frequency
733	MWhOut_Total
730	PowerFactor
728	ReactivePwr
727	RealPwr
759	TotDemand
764	TotPeakDemand
169	TripAlarm
710	VoltageAB
712	VoltageBC
714	VoltageCA
152	TemperaureAlarm
207	FaultAlarm
771	THD_IA_Pri
772	THD_IB_Pri
773	THD_IC_Pri
777	THD_VA_Pri
778	THD_VB_Pri
779	THD_VC_Pri
784	WindingTempMax

Attachment 3.4

SEL Device Monitoring Points (Modbus to SCADA /RTU)

**SEL-700G**

<b>TCP Modbus Register</b>	<b>Signal</b>
689	ApparentPwr
651	CurrentA
653	CurrentB
655	CurrentC
664	CurrentImbal
1806	Enabled
1827	Fault
690	Frequency
691	MWhOut_HighWord
692	MWhOut_LowWord
689	PowerFactor
687	ReactivePwr
686	RealPwr
1694	TotDemand
1699	TotPeakDemand
1806	TripAlarm
668	VoltageAB
670	VoltageBC
672	VoltageCA
685	VoltageImbal
692	MWhOut_Total
144	BreakerClosed



Attachment ~~0~~- 3.4

**SEL Device Monitoring Points (Modbus to SCADA /RTU)**

**SEL-849**

<b>TCP Modbus Register</b>	<b>Signal</b>
	ApparentPwr
	CurrentA
	CurrentB
	CurrentC
	CurrentImbal
	Enabled
	Fault
	Frequency
	MWhOut_HighWord
	MWhOut_LowWord
	MWhOut_Total
	PowerFactor
	ReactivePwr
	RealPwr
	TotDemand
	TotPeakDemand
	TripAlarm
	VoltageAB
	VoltageBC
	VoltageCA
	VoltageImbal

**Other Devices and Monitoring Data evaluated based on Project Requirements and Specific Criteria needed**



**Appendix 4**  
**PG&E Information**

The PG&E Utility Planner:

Mr. Jose Saldana

PG&E Representative

Phone: 831 784-3574

Email: [JFSE@PGE.com](mailto:JFSE@PGE.com)

PG&E Application Number: 112903042

Secondary Arc Flash Assessment – PG&E Distribution System



## Secondary Arc Flash Assessment – PG&E Distribution System

Date: 12/14/17

PG&E Representative:

Telephone #:

Dear Customer,

PG&E recommends that all electrical work on the main breaker to the service panel be done in a de-energized condition to eliminate arc flash hazards.

PG&E's electric system is dynamic, and due to its many variables a range of impedances should be considered in an arc flash assessment. The dynamics of the system include:

- The electric system that is feeding your location is continually being reconfigured due to system needs and general maintenance. These changes can lead to significant changes in the system impedance.
- When a distribution transformer is replaced, the size is reassessed based on the expected loading, and the replacement transformer can have an impedance anywhere in the range specified in Attachment 1.
- The protective devices associated with the distribution transformer are intended to provide protection to the primary system, and should not be relied upon to protect the service panel or customer systems.

The following data should be used for the system impedance:

**Maximum:** 500 MVA  
**Minimum:** 4.5 MVA  
**Maximum X/R ratio:** 40

It has been determined that at the following location:

Address: Street: General Jim Moore at Ardennes  
City: Seaside

The present system characteristics are:

	Circuit Base Voltage:	12 kV: 12470 V
	System Positive Sequence Impedance:	0.8454 ΩR 2.6802 ΩX
	System Zero Sequence Impedance:	1.29794 ΩR 5.0996 ΩX
	3Ø Asymmetric:	2924 A
System Short Circuit Duty	3Ø Symmetric:	2589 A
	Single-Line to Ground:	2006 A

The existing distribution transformer characteristics are:

External Primary Protective Device - Type, Size and Setting (when available from mapped data) <sup>1</sup> :	Recloser, 400A rating; Phase Trip = 200A, Phase Slow Curve = 165; Ground Trip = 70A, Ground Slow Curve = 165
Transformer Type:	3 Phase Pad Mount (Tbl 3)
Transformer Size:	kVA
Transformer Phase-Phase Primary Voltage:	12000 V
Transformer Secondary Voltage:	277/480 3 Phase
Transformer Impedance:	See specified table in Attachment 1

<sup>1</sup> This is often not available from mapped data or not applicable to the transformer type.

**PG&E Distribution System and Arc Flash Assessment  
Attachment 1 – System Voltages & Transformer Impedance Ranges**

The impedance of PG&E’s transformers is required to be within the indicated range. Either the design or tested impedance of the transformer is recorded on the transformer nameplate. A field check and an electrical shutdown may be required to read the nameplate.

Each table below lists the full range of transformer sizes for each transformer type. At the time of replacement, any size listed in the table could be installed. For Example: Referring to Table 3a the possible replacement transformer sizes for a 3-phase 300kVA 208Y/120V pad-mount transformer range from 75 kVA to 1000 kVA.

**Table 1: Single-Phase Pad-Mount Transformer Impedance Range**

Transformer kVA	Secondary Voltage	
	120/240	
	Minimum	Maximum
25-75	1.4%	2.4%
100	1.8%	3.0%
167-500	2.0%	5.0%

**Table 2: Duplex Transformer Impedance Range**

Transformer kVA	Secondary Voltage	
	120/240	
	Minimum	Maximum
25/10 – 75/15	1.4%	2.4%
100/25 – 100/50	1.8%	3.0%

**Table 3: Three-Phase Pad-Mount Transformer Impedance Range**

Transformer kVA	Secondary Voltage	
	208Y/120 or 240/120	
	Minimum	Maximum
45-75	1.4%	3.5%
112.5-225	1.9%	4.5%
300	2.8%	4.5%
500-1000	5.3%	6.2%

Transformer kVA	Secondary Voltage	
	480Y/277	
	Minimum	Maximum
45-75	1.4%	4.5%
112.5-225	1.4%	4.5%
300-500	1.9%	4.5%
750-3325	5.3%	6.2%

Transformer kVA	Secondary Voltage	
	2400/4160Y/2400	
	Minimum	Maximum
300	1.9%	4.5%
750-3325	5.3%	6.2%

**Table 4: Single-Phase Subsurface Transformer Impedance Range**

Transformer kVA	Secondary Voltage	
	120/240 or 240/480	
	Minimum	Maximum
25 and 50	1.4%	2.4%
100	1.8%	3.0%
167 and larger	2.0%	5.0%

**PG&E Distribution System and Arc Flash Assessment  
Attachment 1 – System Voltages & Transformer Impedance Ranges**

**Table 5: Three-Phase Subsurface and Vault Transformer Impedance Range**

Transformer kVA	Secondary Voltage	
	208Y/120	
	Minimum	Maximum
112.5-150	1.9%	4.5%
300	2.8%	4.5%
500-1000	5.3%	6.2%

Transformer kVA	Secondary Voltage	
	480Y/277	
	Minimum	Maximum
112.5-150	1.4%	4.5%
300-500	1.9%	4.5%
750-2500	5.3%	6.2%

**Table 6: Single-Phase Overhead Transformer Impedance Range**

Transformer kVA	Secondary Voltage	
	120/240	
	Minimum	Maximum
5-75	1.4%	2.4%
100	1.8%	3.0%
167-500	2.0%	5.0%

Transformer kVA	Secondary Voltage	
	240/480	
	Minimum	Maximum
5-75	1.4%	2.4%
100	1.8%	3.0%
167-500	2.0%	5.0%

Transformer kVA	Secondary Voltage	
	4160/2400	
	Minimum	Maximum
50-500	2.0%	5.4%

**Table 7: Three-Phase Overhead Transformer Impedance Range**

Transformer kVA	Secondary Voltage	
	208Y/120	
	Minimum	Maximum
45 – 112.5	1.4%	3.5%
150	1.9%	4.5%
225	2.1%	4.5%
300	2.8%	4.5%

Transformer kVA	Secondary Voltage	
	480Y/277	
	Minimum	Maximum
45 – 112.5	1.4%	4.5%
150	1.4%	4.5%
225	1.4%	4.5%
300	1.9%	4.5%

**PG&E Distribution System Base Voltages:**

4160, 4800, 12470, 18000, 21600, 34500 V

**PG&E Distribution Transformer Primary Base Voltages:**

2400, 4160, 4800, 6930, 7200, 12000, 17200, 20780, 34500 V





## **Appendix 5**

Figure 1. Project Location Map

Exhibit 3: Site Plan

Plate 2: Monitoring Wells No. 1 Location Map

Disposal Location Map

EL-4: Sample One-line Diagram Pump Station

EL-07: Sample VFD Schematic Wiring Diagram

Tree Removal Map ASR-6 Site

Tree Removal Map ASR-5 Site

Email: 12/12/2017 PGE Power Grid (Fort Ord Circuit)

PGE Application for Power for ASR 5 and ASR 6, (app. #  
112903042)



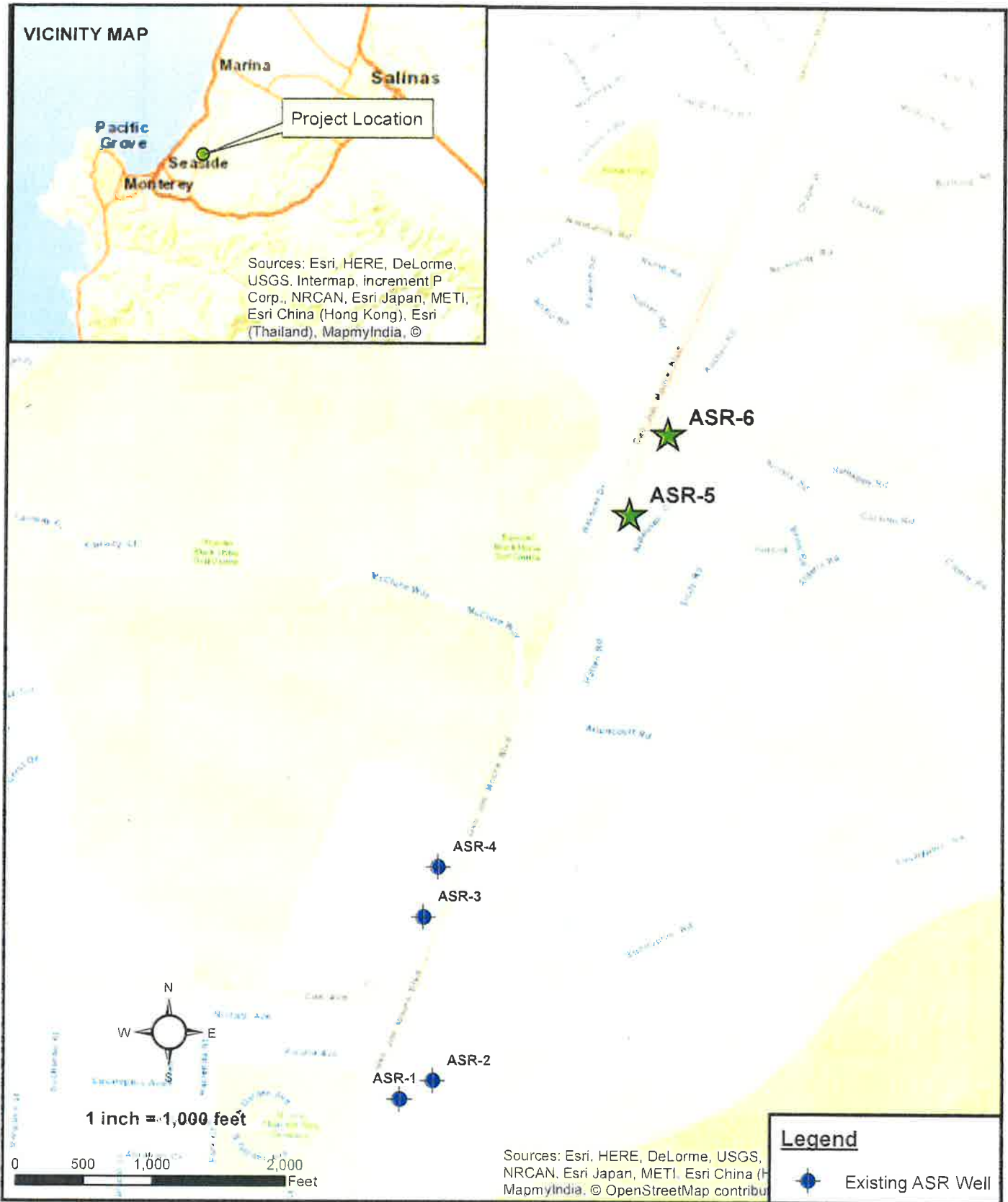

**FIGURE 1. PROJECT LOCATION MAP**  
Fitch Park ASR-5 and ASR-6 Project  
California American Water

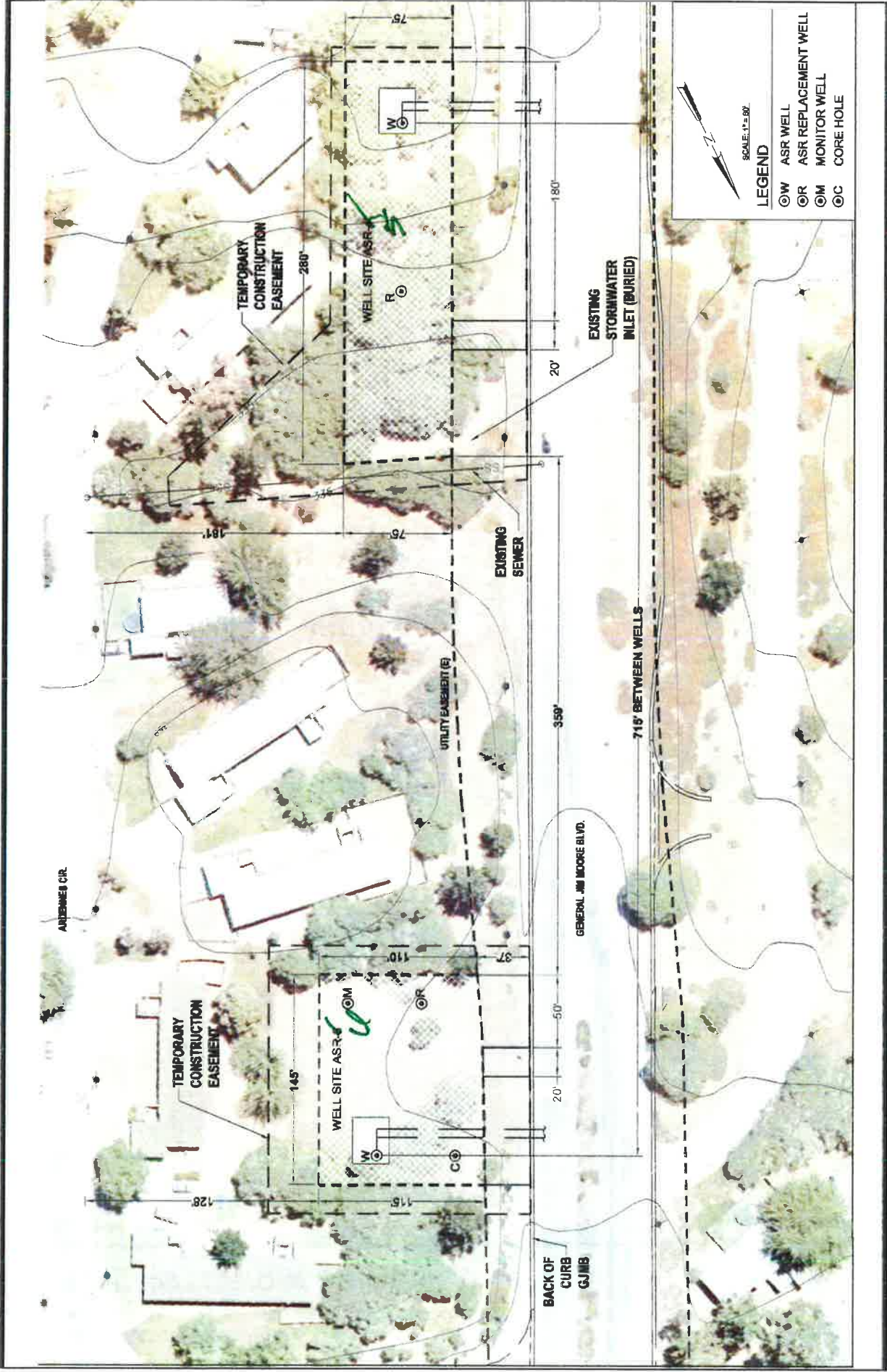

## SITE PLAN

Coastal Water Project - Aquifer Storage and Recovery (ASR)

Exhibit 3





SCALE: 1" = 60'

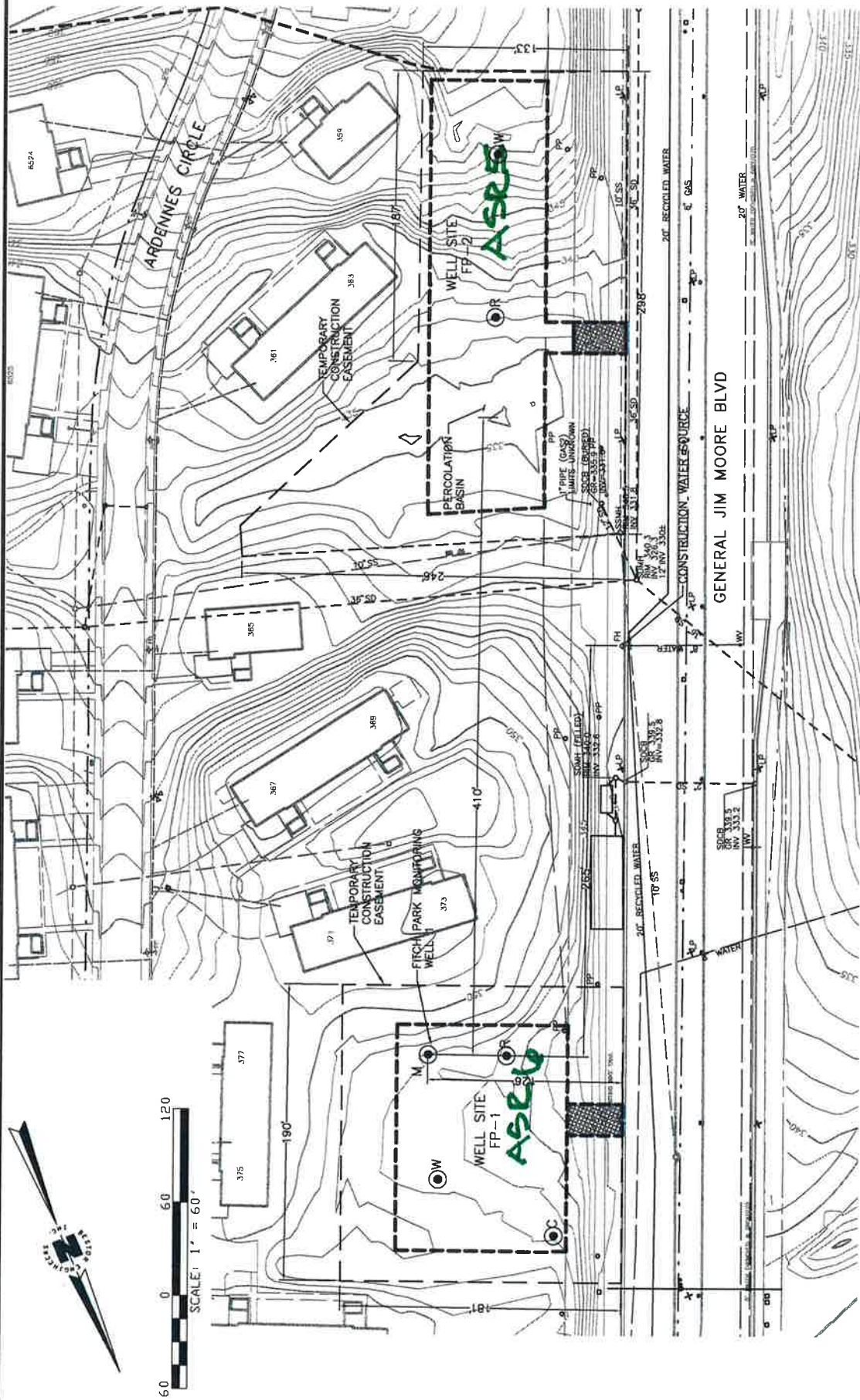

<p>California AMERICAN WATER</p>	<p>Monterey Division 511 Forest Lodge Road, Ste. 100 Pacific Grove, CA 93950</p>	<p>REV</p> <table border="1"> <thead> <tr> <th>DESCRIPTION</th> <th>BY</th> <th>DATE</th> <th>APPR</th> </tr> </thead> <tbody> <tr> <td> </td> <td> </td> <td> </td> <td> </td> </tr> <tr> <td> </td> <td> </td> <td> </td> <td> </td> </tr> <tr> <td> </td> <td> </td> <td> </td> <td> </td> </tr> </tbody> </table>	DESCRIPTION	BY	DATE	APPR													<p>DATE: MAY 8, 2010</p> <p>DRAWN: STAFF</p> <p>DESIGN: STAFF</p> <p>CHECKED: H.P. WIND</p> <p>PROJECT DESIGNER: JAMIE PLATZ</p>	<p>PROJECT NAME: MONTEREY BAY REGIONAL WATER SUPPLY PROJECT ASR TEST WELLS</p> <p>PROJECT FILE: PLATE 2 - MONITORING WELL NO. 1 LOCATION MAP</p>	<p>DATE PLOTTED: 05/11/10</p> <p>SCALE: 1" = 60'</p> <p>PROJECT NO.: 08-000</p> <p>DATE: 05/11/10</p> <p>DESIGNER: H.P. WIND</p> <p>CHECKED: JAMIE PLATZ</p> <p>PROJECT NO.: 08-000</p> <p>DATE: 05/11/10</p>
	DESCRIPTION	BY	DATE	APPR																	
<p>1</p>																					



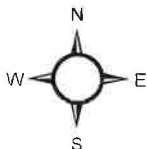
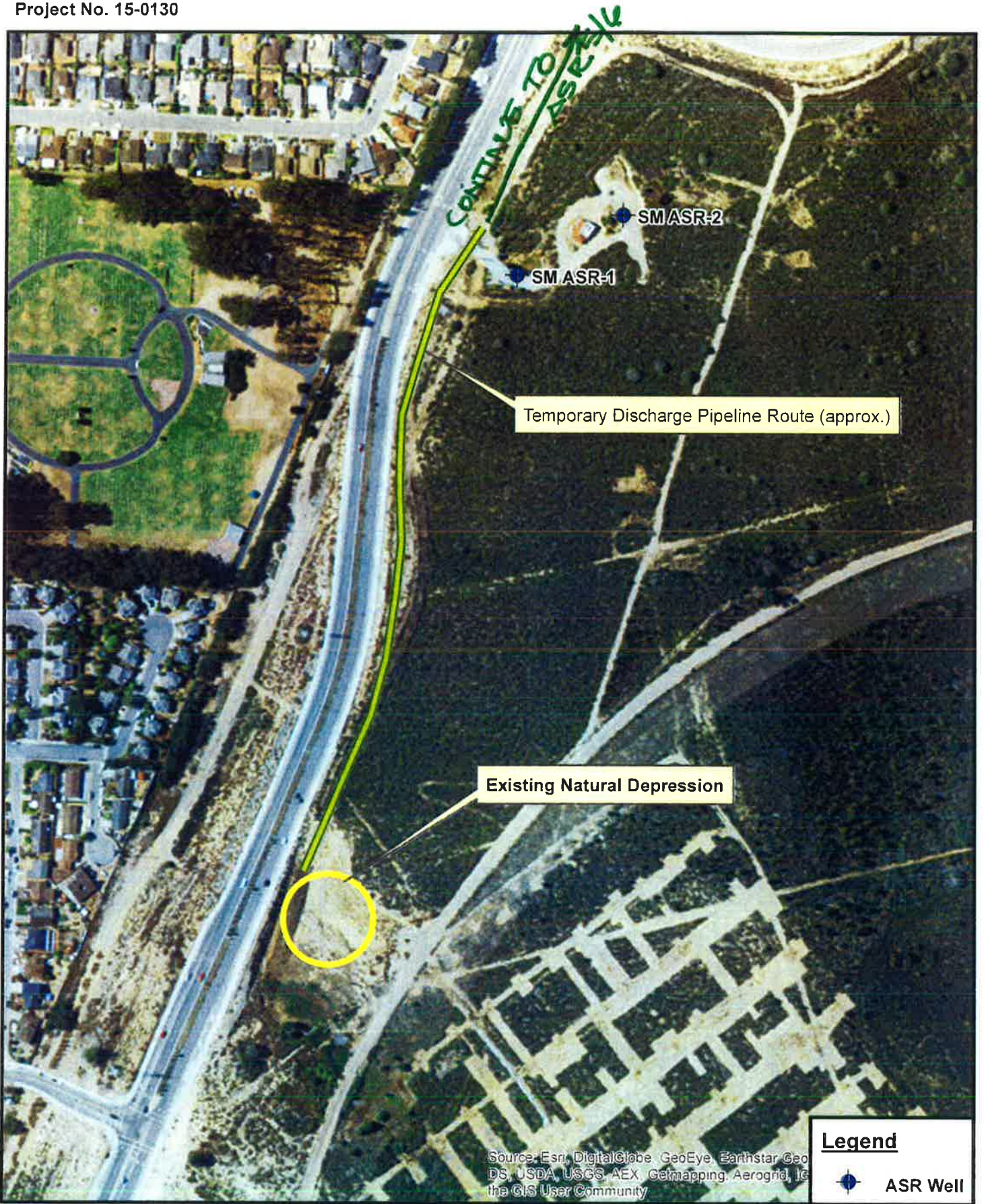
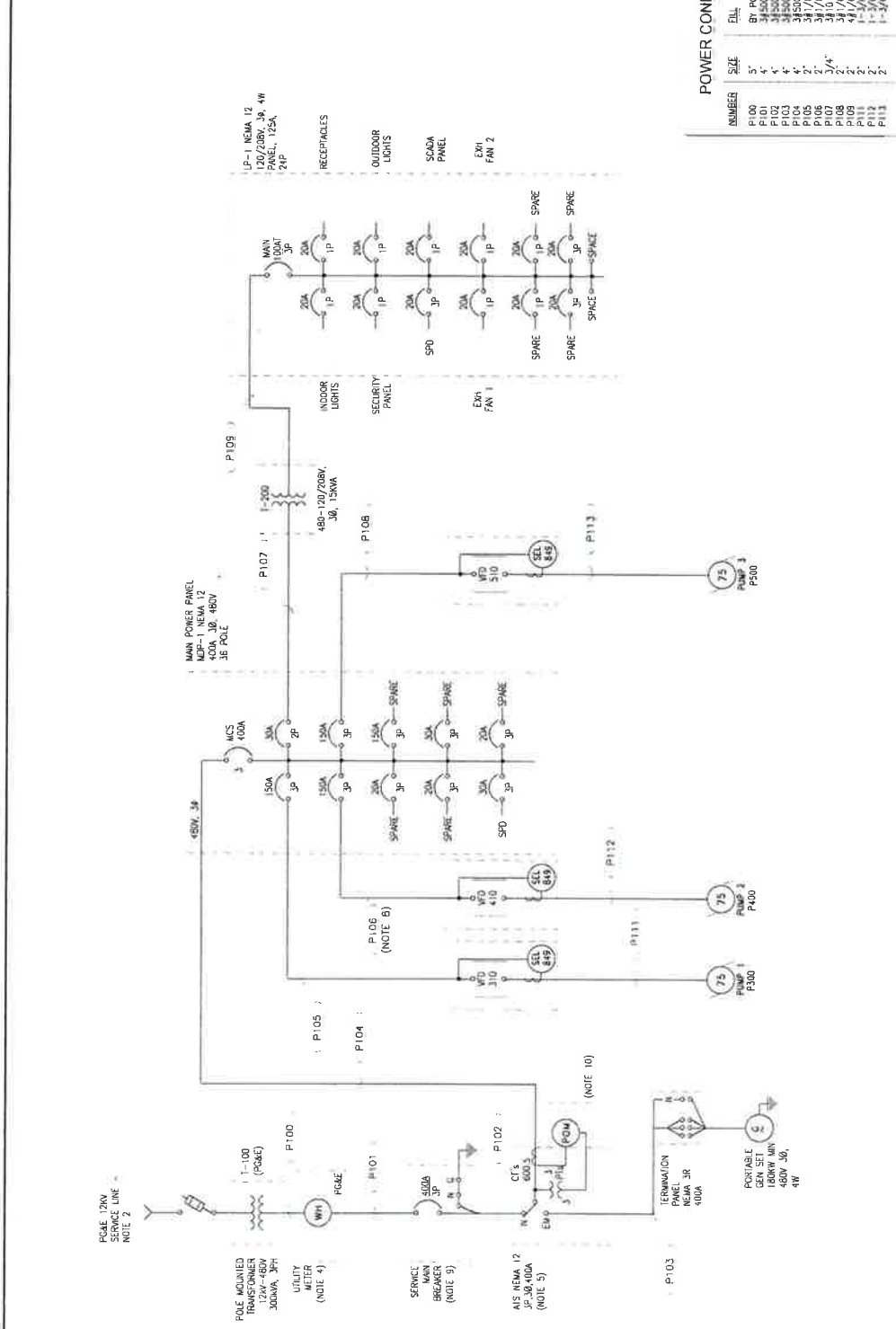

**FIGURE 1. DISCHARGE DISPOSAL LOCATION MAP**  
Fitch Park ASR-5 and ASR-6 Project  
California American Water



SHEET NOTES:

1. SEE SITE PLAN FOR GENERAL ELECTRICAL NOTES.
2. ELECTRICAL SERVICES AND METERING PANEL DRAWINGS SHALL BE SUBMITTED TO THE CITY ENGINEER FOR REVIEW AND APPROVAL BEFORE PLACING EQUIPMENT ORDER.
3. CONTRACTOR TO CONFIRM SERVICE CONDUIT SIZE AND TRENCH DEPTH AND TRENCH CONSTRUCTION IN ACCORDANCE WITH POLE REQUIREMENTS.
4. CONTRACTOR SHALL PROVIDE SERVICE METER PANEL IN ACCORDANCE WITH POLE METER REQUIREMENTS.
5. AUTOMATIC TRANSFER SWITCH (RATED 480V, 480V, 3 POLE) SHALL BE NEMA 12, CONTACTOR TYPE SEE SPECIFICATIONS.
6. CONTRACTOR SHALL PROVIDE STRUCTURAL DESIGN FOR ALL ELECTRICAL PANELS AND PROPOSED PANEL MOUNTING METHODS, INCLUDING SEISMIC AND OVERTURNING CALCULATIONS.
7. CONDUITS SHALL BE PVC, SCHEDULE 40, BELOW GRADE AND RIGID GALVANIZED STEEL ABOVE GRADE WITH PVC COATED GRS SWEEPERS WHERE TRANSITIONING FROM BELOW GRADE TO ABOVE GRADE. ALL CONDUITS SHALL BE IDENTIFIED BY LIQUID TIGHT FLEXIBLE METAL CONDUIT FOR FINAL CONNECTIONS TO FIELD DEVICES (E.G., MOTORS, FLOW METER TRANSMITTERS). SEE SPECIFICATIONS FOR COMPLETE CONDUIT AND CONDUIT REQUIREMENTS.
8. CONTRACTOR SHALL PROVIDE SEPARATE CONDUITS FOR EACH VFD POWER CIRCUIT AND CONTROL DEVICES WITH EACH VFD POWER CONDUITS. ONLY TWO PUMPS WILL RUN AT ONE TIME.
9. MAIN BREAKER SHALL BE SOLID STATE ADJUSTABLE TRIP. SEE SPECIFICATIONS.
10. GAW POWER QUALITY METER SHALL BE SEL 735. PROVIDE CAT 6 RADDOUT TO SCADA PANEL.



NUMBERS	SIZE	FILL (CU WIRE)	EGRAL
P100	5"	BY BREAK	1-100
P101	4"	3450KCMIL #1/0 NEUT #1/0 GND	UTILITY METER
P102	4"	3450KCMIL #1/0 NEUT #1/0 GND	UTILITY METER
P103	4"	3450KCMIL #1/0 NEUT #1/0 GND	ATS
P104	4"	3450KCMIL #1/0 NEUT #1/0 GND	ATS
P105	2"	341/0 #5 GND	MAIN POWER PANEL
P106	2"	341/0 #5 GND	MAIN POWER PANEL
P107	3/4"	341/0 #5 GND	MAIN POWER PANEL
P108	2"	441/0 #6 GND	MAIN POWER PANEL
P109	2"	1-3/4" #5 SHIELDED #6 GND	VFD-10
P110	2"	1-3/4" #5 SHIELDED #6 GND	VFD-10
P111	2"	1-3/4" #5 SHIELDED #6 GND	VFD-10
P112	2"	1-3/4" #5 SHIELDED #6 GND	VFD-10
P113	2"	1-3/4" #5 SHIELDED #6 GND	VFD-10

CARMEL VALLEY PUMP STATION ELECTRICAL SINGLE LINE DIAGRAM

CALIFORNIA AMERICAN WATER

1600 W. SUITE 400, OAKLAND, CALIFORNIA 94612

PROJECT NO. 2118, KHALSA

DATE: APRIL 2018

USE DIMENSIONS ONLY UNLESS OTHERWISE SPECIFIED

FOR CONSTRUCTION PURPOSES

EL-04

SAMPLE

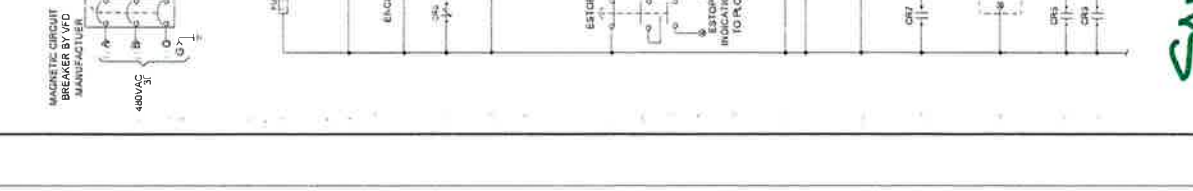
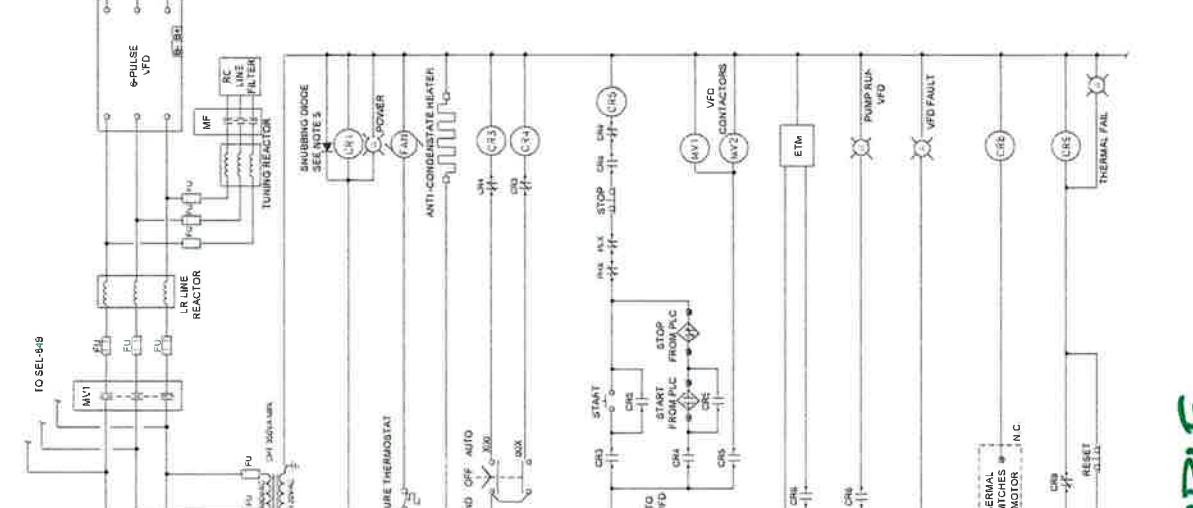
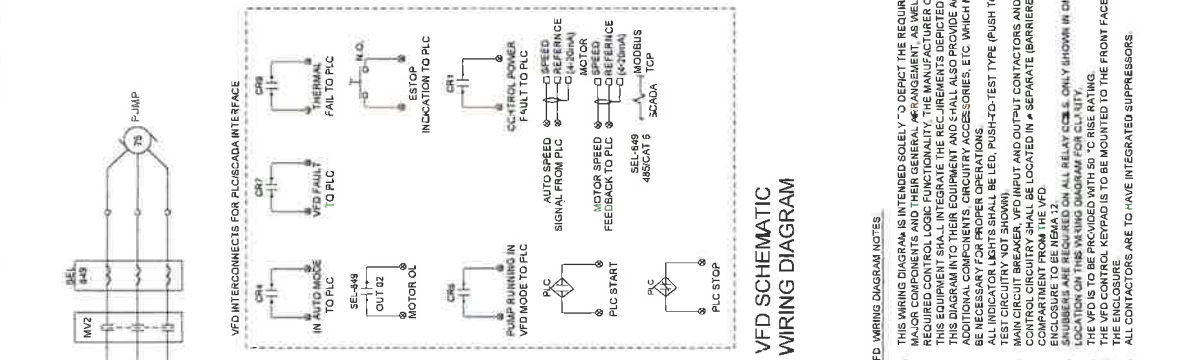
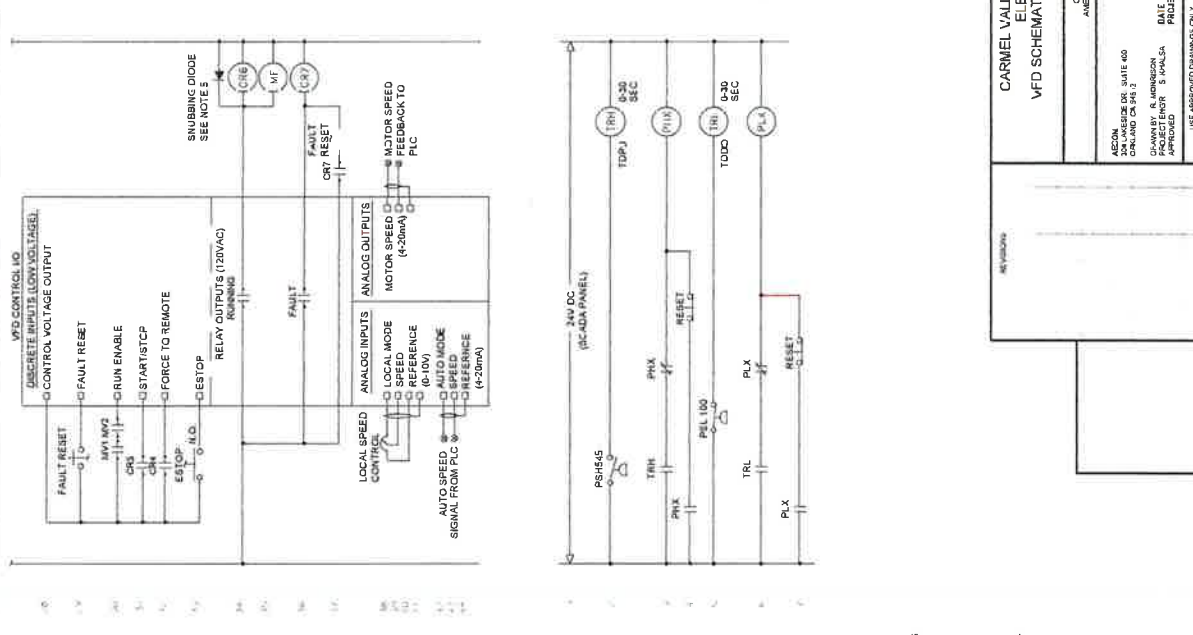

VFD SCHEMATIC WIRING DIAGRAM

VFD WIRING DIAGRAM NOTES

1. THIS WIRING DIAGRAM IS INTENDED SOLELY TO DEPICT THE REQUIRED MAJOR COMPONENTS AND THEIR GENERAL ARRANGEMENT, AS WELL AS THE ELECTRICAL CONNECTIONS BETWEEN THEM. THE MANUFACTURER OF THIS EQUIPMENT SHALL INTEGRATE THE REQUIREMENTS DESCRIBED BY THIS DIAGRAM INTO THEIR EQUIPMENT AND SHALL ALSO PROVIDE ANY ADDITIONAL COMPONENTS, CIRCUITRY ACCESSORIES, ETC. WHICH MAY BE NECESSARY FOR PROPER OPERATIONS.
2. ALL ELECTRICAL CONNECTIONS SHALL BE MADE TO THE TERMINALS SHOWN. TEST CIRCUITRY NOT SHOWN.
3. MAIN CIRCUIT BREAKER, VFD INPUT AND OUTPUT CONTACTORS AND ALL CONTROL CIRCUITRY SHALL BE LOCATED IN A SEPARATE (BARRIERED) COMPARTMENT FROM THE VFD.
4. SUPPRESSORS ARE REQUIRED ON ALL RELAY COILS ONLY SHOWN IN THIS DIAGRAM ON THIS WIRING DIAGRAM FOR CLARITY.
5. THE VFD IS TO BE PROVIDED WITH 50 °C RISE RATING.
6. THE PUMP MOTOR REPHAS IS TO BE MOUNTED TO THE FRONT FACE OF THE PUMP MOTOR.
7. THE PUMP MOTOR REPHAS IS TO BE MOUNTED TO THE FRONT FACE OF THE PUMP MOTOR.
8. ALL CONTACTORS ARE TO HAVE INTEGRATED SUPPRESSORS.

CARMEL VALLEY PUMP STATION ELECTRICAL VFD SCHEMATIC WIRING DIAGRAM	
ACORN 300 LAUREL DR. SUITE 400 DUBLIN, CA 94568 PROJECT NO. 15-0015A APPROVED	DATE PROJECT SCALE AS SHOWN
CALIFORNIA AMERICAN WATER	
USE APPROVED DRAWINGS ONLY FOR CONSTRUCTION PURPOSES	

SAMPLE



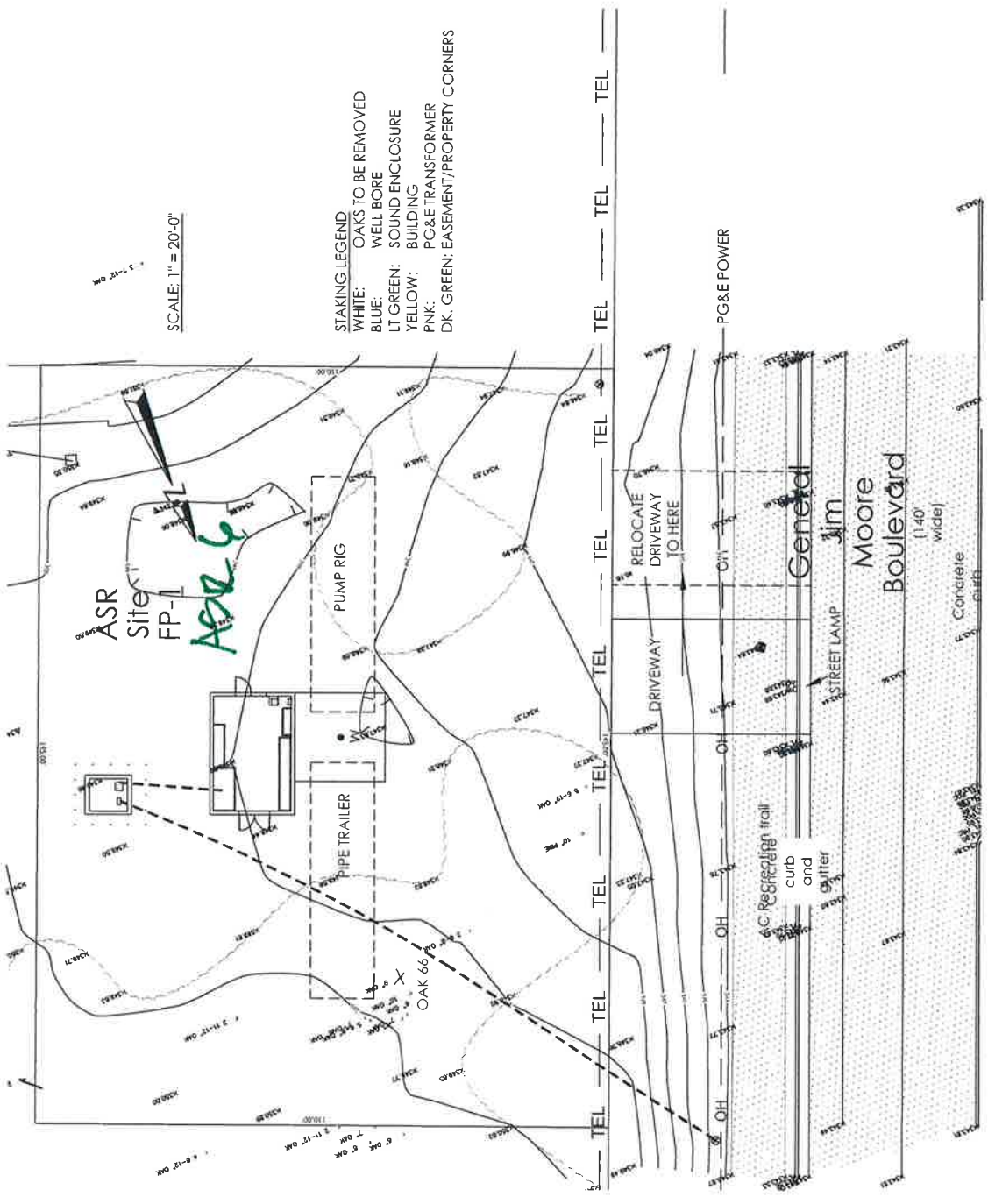

TREE REMOVAL

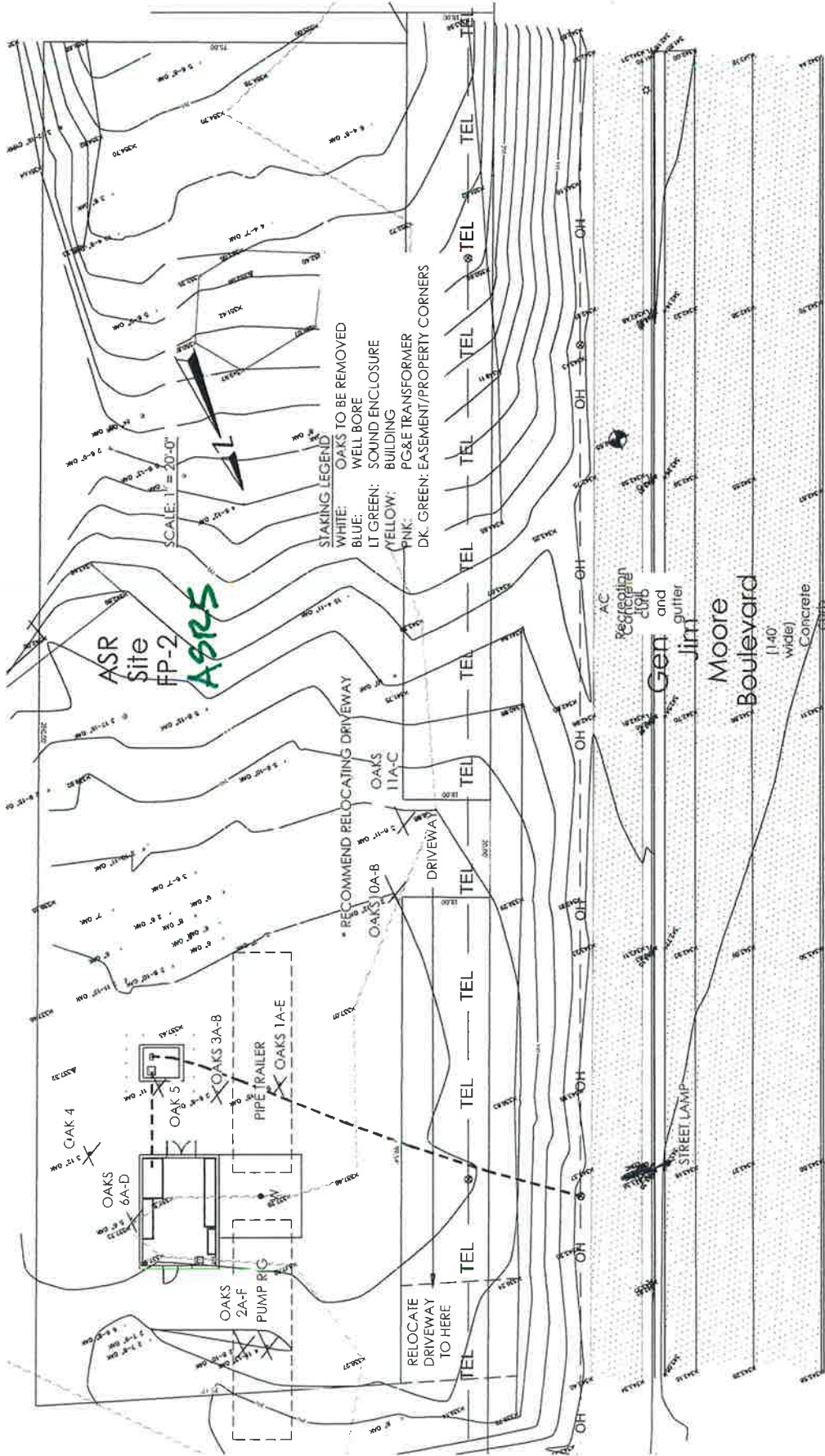

*TREE REMOVAL*

Donald R Monette

From: Saldana, Jose <jf5e@pge.com>  
Sent: Tuesday, December 12, 2017 7:28 AM  
To: Robert Kyoi  
Subject: Gen Jim

PGE POWER GRIDS

Robert;

This is the best I can do regarding Maps:

The Coe Ave Pumps are being fed from a Monterey Circuit and the Ardennes Pumps will be fed from a Fort Ord Circuit.

Thanks  
Jose

ASR 1/2?  
2/4?







**Application for Service**

**New - Commercial**

**Fitch Park Asr**

**Application: 112903042**

**Request**

---

Commodity: Electric (Underground)  
Other Services: Temporary Power  
Submitted on: 06/01/2017

Service Needed By: 07/01/19

PG&E Rep: Jfse  
Jose.saldana@pge.com  
831-784-3574

**Contacts**

---

*Applicant:*

Chris Cook  
California American Water, Central Divis  
511 Forest Lodge Road, Suite 100  
Pacific Grove, CA 93950  
831-646-3241 (day)  
8312772405 (cell)  
Christopher.cook@amwater.com

*Representative:*

Robert Kiyoi  
4141 State St Suite E10  
Goleta, CA 93110  
805-681-0980 (day)  
8056899253 (cell)  
Rlkiyoi@kiyoieng.com

Contractor:

**Legal**

---

*Signatory:*

Chris Cook  
511 Forest Lodge Road, Suite 100  
Pacific Grove, CA 93950  
831-646-3241  
Christopher.cook@amwater.com

Name on Contract: California American Water

Legal Status: Corporation

State of Incorp: CA

**Billing**

---

Send Bills To: Chris Cook  
Existing Account? No

Mailing Address: 511 Forest Lodge Road,  
Suite 100  
Pacific Grove CA 93950  
Phone: 831-646-3241  
Email: Christopher.cook@amwater.cor



# Fitch Park Asr

# Application: 112903042

## Project Description

Project Type: <b>Industrial Service (new)</b>	Project Address: <b>General Jim Moore Blvd @ Ardennes Circle SAND CITY 93955</b>
Location Latitude:	
Location Longitude:	County: <b>MONTEREY</b>
NAICS Code:	Cross Street: <b>Ardennes Circle</b>
Business Activity: <b>Water Supply</b>	Number of Buildings: <b>1</b>
Assessor Parcel No: <b>N/a</b>	Number of Floors: <b>1</b>
Building Permit No:	No. of Svc Locations: <b>1</b>
	Total Sq Footage: <b>600</b>

## Service Details

No. of Electric Meters: **1**  
 Main Switch Size: **2500**  
 Voltage: **480/277-4wire-3phase**  
 Electric Rate Schedule: **E-25**

## Temporary Power

Needed for <1 Year? **No**  
 If temporary power will be used for > a year,  
 additional Federal and State taxes will need to be  
 collected.

Temporary Power  
 Needed By:  
  
 Will Applicant or a  
 Contractor install pole? **No**  
 Main Switch Size:

## Design Contractor

Will you be using a  
 Design Contractor? **No**

PG&E must provide project specific information to design  
 contractors. PG&E can provide this information sooner if we know  
 whether or not you are considering using a design contractor to  
 design gas/electric distribution or service facilities.

Providing this information on this Application is voluntary and is not binding. PG&E will provide you with a bid for the design work



**Fitch Park Asr****Application: 112903042**

regardless of whether or not you answer this question now and will not require a final decision from you until later in the process.

**Construction**

Existing PG&amp;E facilities require?

Relocation or Removal: **No**Undergrounding: **No****Service Trench****Distribution Trench**Who will install Applicant  
conduits/substructure?Who will install Pge  
conduits/substructure?Who will trench and  
backfill:Who will trench and  
backfill:Electric Facilities? **Applicant**Electric Facilities? **Pge**

Gas Facilities?

Trench Occupants: **Electric Phone**Trench Occupants: **Electric Phone**Trench Needed By: **06/01/19**Trench Needed By: **06/01/19**Joint Trench Drawings **Applicant**Joint Trench Drawings **Applicant**

Prepared by:

Prepared by:

**Trench Information**Transformer Type: **P****Electric Load**

Submersible Pump?

Largest 1 Phase Motor: **1.0**Largest 3 Phase Motor: **800.0**Total 1 Phase Motors: **1.0**Total 3 Phase Motors: **1600.0**

Largest 1 Phase A/C:

Largest 3 Phase A/C: **8**

Appliances &amp; Equipment:

**Street Lights**

Number of Streetlights:

Responsible Party:

Bulb Type:

Mailing Address:

**Fitch Park Asr****Application: 112903042**

Watts Per Lamp:

Rate Schedule:

**Self Generation**

---

Are you planning on  
installing any  
self-generation  
equipment? **No**

Type of Generation:

Total Output of All  
Generation:

No.of Generation Units:

**Operating Hours**

---

Typical Operating Hrs: From: 00:00 To: 00:00

Days open per week: 7

Other Details:

Months open per year: 12

**Documents****Customer Comments:**

---

06/01/2017 13:21:29 The 2 Large 800 Hp Motors Will Be On Variable Frequency Drives To Limit Motor Inrush.we Are Submitting Our Application So That Discussions Can Begin Regarding Any Distribution Line Work That May Be Required To Feed The Facility.we Would Like To Meet With A Planner To Do A Preliminary Field Survey Of The Site And To Discuss Options.our Facility Plans Are Pending.